

**FINAL REPORT FORM.**

From: 5-A.

अंतिम अहवाल नमुना

(Under Section 173 Cr.P.C.)

(फौजदारी प्रकिया संहितेच्या कलम १७३ अन्वये)

**\* IN THE COURT OF मा. महानगर दंडाधिकारी, ६५ वे न्यायालय, अंधेरी, मुंबई**  
न्यायालय.....

1. \* Dist **मुंबई** \*P.S. **सहार** \*Year **२०२३** \*FIR No **१५५** \*Date **२५/०४/२०२३**  
जिल्हा पोलीस ठाणे सन पहिली खबर क्र. तारीख

2. Final Report /Charge Sheet No ..... 3.\* Date .....  
अंतिम अहवाल/आरोपपत्र क्रमांक तारीख

3. (i) \*Act **भादवि** \*Section **१२०(ब),४०८,४०९,४७७(अ),४२०,३४** भादवि  
अधिनियम कलम  
(iii) \*Act..... \*Section-----  
अधिनियम कलम  
(iv) \*Act..... \*Section-----  
अधिनियम कलम

4. \*Type of Final Form/Repot: Charge Sheet/Not Charge sheeted for want of evidence /FR  
Undetected/ FR offence abated/FR Uncured :.....  
अंतिम अहवालाचा प्रकार : आरोपपत्र दाखल केले/पुरव्या अभावी आरोपपत्र दाखल केले नाही/तपास लागला नाही/शोध लागला नाही/संपविला/घडलाच नाही.

..... आरोपपत्र दाखल केले .....

5. If FR Uncured: False/Mistake of Fact/Mistake of Law/ Non-cognizable/Civil

Nature:.....  
जर अंतिम अहवालाचा प्रकार घडलाच नाही: खोटी/वास्तुस्थितीची चूक/कायद्याची चूक/अदखलपात्र/दिवाणी स्वरूप

6. \*If Chargesheeted- ( जर आरोपपत्र ठेवले ) :

Original/Supplementary (मुळ/पुरवणी): .....मुळ.....

7 \*Name of the I.O.: **संदीप लक्ष्मण शिंदे** Rank:..... **सहाय्यक पो. निरीक्षक** No .....  
तपासणी अधिकाऱ्याचे नांव पदनाम क्रमांक

8 (a) Name of Complainant/Informant **श्री. अमीत अगरवाल** .....  
तक्रारदायचे / खबरीचे नांव

(b) Father's/Husband's NAME:..... **कमल अगरवाल** .....  
पित्याचे / पतीचे नांव

9. Details of Properties/Articles/Documents/seized during investigation and relied upon:  
(separate list can be attached if necessary)

तपासणीच्या वेळी परत मिळविलेल्या/जप्त केलेल्या आणि अवलंबून राहिलेल्या मालमत्तेचा/वस्तुचा तपसील  
(आवश्यक असेल तर स्वतंत्र यादी सोबत जोडण्यात येईल)

Sr.No अ.क्र	Property Description मालमत्तेचे वर्णन	Estimated Value(in Rs.) अंदाजे मुल्य (रूपये)	P.S.Property Register No. पोलीस ठाणे मालमत्ता नोंद वही क्रमांक	From whom/ where Registered or Seized (कोणकडून/कोतुन परत मिळविलेली किंवा जप्त केली)	Disposal विल्हेवाट

(G.C.P.) K 2297

Form: 5-B

10. Particulars of accused persons charge-sheeted (use separate sheet for each accused):

आरोपपत्र ठेवलेल्या आरोपीचा तपशील ( प्रत्येक आरोपीसाठी स्वतंत्र कागद वापरावा)

- (1) \* Name: गिरीषकुमार जगदीशप्रसाद अग्रवाल Whether verified:... होय...  
नांव पडताळले किंवा काय
- (2) Father`s/Husband`s Name:... जगदीशप्रसाद अग्रवाल .....
- (3) पित्याचे /पतीचे नांव
- (4) Date/Year of Birth :जन्म तारीख / .. ४० वर्षे.....
- (5) Sex:.....पुरुष ..... (v).Nationality:... भारतीय.....  
लिंग राष्ट्रीयत्व
- (6) Passport No: Date of Issue: Place of Issue.  
पारपत्र क्र. दिल्याची ताराख दिल्याचे ठिकाण
- (7) Religion:...हिंदु.....(viii)Whether SC/ST:.....  
धर्म अनुसूचित जातीचा/जमातीचा आहे काय
- (8) Occupation (व्यवसाय).....
- (9) Address (पत्ता) ... ए-४० केवल कुंज अपार्टमेंट, सेक्टर-१३, रोहीणी,  
डी.डी. क्लब जवळ, दिल्ली-११००८५
- (10) Whether verified (पडताळला किंवा काय):...नाही.....
- (11) \*Provisional Criminal No( तपत्पुरता गुन्हेगार क्र.):... ०१.....
- (12) \*Regular Criminal No(if known) नियमित गुन्हेगार क्र. ( माहित असल्यास ):
- (13) \*Date of Arrest (अटकेची तारीख):...१५ / ०६ / २०२३.....
- (14) Date of release on bail (जामीनावर सोडल्याची तारीख):.....
- (15) \*Date on which forwarded to court (न्यायालयाकडे पाठविल्याची तारीख): ...१६ / ०६ / २०२३.....
- (16) \*Under Acts& Sections: .. १२०(ब),४०८,४०९,४७७(अ),४२०,३४ भादवि  
कोणत्या अधिनियमाखाली व कलमाखाली
- (17) \*Name(s) of bailers/sureties and Address(es):.....  
जामीनदारांची नावे पत्ते
- (18) Previous convictions with case references(प्रकरणाच्या संदर्भासह पुर्वीची अपराधसिध्दी ).....
- (19) \*Status of the accused :(आरोपीची स्थिती )... न्यायालयीन कोठडीत आहे.  
Forwarded/Bailed by Police Custody/Bailed by Court/In Judicial Custody/  
Absconding/Proclaimed Offender:  
पुढे पाठविले पोलीसांनी जामीनावर सोडले/पोलीस कोठडीत/न्यायालयाने जामीनावर सोडले/न्यायालयीन  
कोठडीत/फरारी उद्घोषित.

## 10. Particulars of accused persons charge-sheeted (use separate sheet for each accused):

आरोपपत्र ठेवलेल्या आरोपीचा तपशील ( प्रत्येक आरोपीसाठी स्वतंत्र कागद वापरावा)

- (1) \* Name: स्वप्नील बबन चव्हाण, Whether verified:... होय...  
नांव पडताळले किंवा काय
- (2) Father's/Husband's Name:... बबन चव्हाण .....
- (3) पित्याचे /पतीचे नांव
- (4) Date/Year of Birth :जन्म तारीख / .. ३४ वर्षे.....
- (5) Sex:.....पुरुष ..... (v).Nationality:... भारतीय.....  
लिंग राष्ट्रीयत्व
- (6) Passport No: Date of Issue: Place of Issue.  
पारपत्र क्र. दिल्याची तारीख दिल्याचे ठिकाण
- (7) Religion:...हिंदु.....(viii)Whether SC/ST:.....  
धर्म अनुसूचित जातीचा/जमातीचा आहे काय
- (8) Occupation (व्यवसाय).....
- (9) Address (पत्ता) ... चव्हाण हाऊस, मरोळ मरोशी रोड, आय.सी.आय.सी.आय बँक,  
लोकदर्शन समोर, अंधेरी (पुर्व), मुंबई-४०००५९
- (10) Whether verified (पडताळला किंवा काय):... नाही.....
- (11) \*Provisional Criminal No( तपत्पुरता गुन्हेगार क्र.):...०२.....
- (12) \*Regular Criminal No(if known) नियमित गुन्हेगार क्र. ( माहित असल्यास ):
- (13) \*Date of Arrest (अटकचे तारीख):... १५ / ०६ / २०२३.....
- (14) Date of release on bail (जामीनावर सोडल्याची तारीख):.....
- (15) \*Date on which forwarded to court (न्यायालयाकडे पाठविल्याची तारीख): ...१६ / ०६ / २०२३.....
- (16) \*Under Acts& Sections: .. १२०(ब),४०८,४०९,४७७(अ),४२०,३४ भादवि  
कोणत्या अधिनियमाखाली व कलमाखाली
- (17) \*Name(s) of bailers/sureties and Address(es):.....  
जामीनदारांची नावे पत्ते
- (18) Previous convictions with case references(प्रकरणाच्या संदर्भासह पुर्वीची अपराधसिध्दी ).....
- (19) \*Status of the accused :(आरोपीची स्थिती )... न्यायालयीन कोठडीत आहे.  
Forwarded/Bailed by Police Custody/Bailed by Court/In Judicial Custody/  
Absconding/Proclaimed Offender:  
पुढे पाठविले पोलीसांनी जामीनावर सोडले/पोलीस कोठडीत/न्यायालयाने जामीनावर सोडले/न्यायालयीन  
कोठडीत/फरारी उद्घोषित.

## 11. Particulars of Wanted accused persons:-

पाहीजे आरोपीचा तपशील (प्रत्येक आरोपीसाठी स्वतंत्र कागद वापरावा)

- (1) \*Name: विमलकुमार जगदीशप्रसाद अगरवाल  
नांव Whether verified:.....  
पडताळले किंवा कार्य
- (2) Father's/Husband's Name:.....  
पित्याचे/पतीचे नांव
- (3) Date/Year of Birth (जन्मतारीख/वर्ष):.....
- (4) Sex:..... पुरुष..... (5) Nationality:.... भारतीय.....  
लिंग राष्ट्रीयत्व
- (6) Passport No:.....Date of Issue:.....Place of Issue:.....  
पारपत्र क्र. दिल्याची तारीख दिल्याचे ठिकाण
- (7) Religion:.... (8) Whether SC/ST:.....  
धर्म अनुसुचित जातीचा/जमातीचा आहे का
- (9) Occupation (व्यवसाय): .....
- (10) Address (पत्ता बि-३०६ साईकृपा अलाईट, फर्नस सिटी रोड, दोधन कुंदी,  
आय.डी.बी.आय. बॅके जवळ, बेंगलोर, कर्नाटक-५६००३७
- (11) Whether verified (पडताळला किंवा काय):.....
- (12) \*Provisional Criminal No (तात्पुरता गुन्हेगार क्र.):... ०१ .....
- (13) \*Suspicion Approved (संशय खरा ठरला काय): Yes/No (होय/नाही):.....
- (14) \*Status of the accused (suspect) आरोपीची स्थिती (संशयित):  
Bailed by Police/Bailed by Court/in Judicial Custody/Absconding/  
Proclaimed offender/Not arrested:  
पोलीसांनी जामीनावर सोडले/न्यायालयाने जामीनावर सोडले/न्यायालयीन कोठडी/फरारी/उदघोषित अपराधी/मिळून आला नाही  
.....मिळून आलेला नाही.....
- (15) \*Under Acts& Sections: .....
- कोणत्या अधिनियमाखाली व कलमाखाली  
Any special remarks including reasons for not charge sheeting:  
आरोपपत्र न ठेवण्याच्या कारणांसह कोणतेही विशेष अभिप्राय:.....  
अटकपुर्व जामिन अर्ज मा. उच्च न्यायालयात प्रलंबित, मा. उच्च न्यायालयाकडून प्राप्त  
आदेशान्वये पुढील कारवाई करून त्याचे विरुद्ध पुरवणी दोषारोपपत्र सादर करण्याची  
तजविज ठेवली आहे.

(G.C.P.) K 2297

Form:5-C

11. Particulars of Wanted accused persons:-

पाहीजे आरोपीचा तपशील (प्रत्येक आरोपीसाठी स्वतंत्र कागद वापरावा)

- (1) \*Name: नुपुर विमलकुमार अगरवाल  
नांव
- (2) Father's/Husband's Name:.....  
पित्याचे/पतीचे नांव
- (3) Date/Year of Birth (जन्मतारीख/वर्ष):.....
- (4) Sex:..... स्त्री.....  
लिंग
- (5) Nationality:... भारतीय.....  
राष्ट्रीयत्व
- (6) Passport No:..... Date of Issue:..... Place of Issue:.....  
पारपत्र क्र. दिल्याची तारीख दिल्याचे ठिकाण
- (7) Religion:... .. (8) Whether SC/ST:.....  
धर्म अनुसुचित जातीचा/जमातीचा आहे का
- (9) Occupation (व्यवसाय): .....
- (10) Address (पत्ता बि-३०६ साईकृपा अलाईट, फर्नस् सिटी रोड, दोधन कुंदी,  
आय.डी.बी.आय. बँके जवळ, बेंगलोर, कर्नाटक-५६००३७
- (11) Whether verified (पडताळला किंचा काय):.....
- (12) \*Provisional Criminal No (तात्पुरता गुन्हेगार क्र.):... ०२.....
- (13) \*Suspicion Approved (संशय खरा ठरला काय): Yes/No (होय/नाही):.....
- (14) \*Status of the accused (suspect) आरोपीची स्थिती (संशयित):  
Bailed by Police/Bailed by Court/in Judicial Custody/Absconding/  
Proclaimed offender/Not arrested:  
पोलीसांनी जामीनावर सोडले/न्यायालयाने जामीनावर सोडले/न्यायालयीन कोठडी/फरारी/उद!षोषित अपराधी/मिळुन आला नाही  
.....मिळुन आली नाही.....
- (15) \*Under Acts& Sections: ..  
कोणत्या अधिनियमाखाली व कलमाखाली  
Any special remarks including reasons for not charge sheeting:  
आरोपपत्र न ठेवण्याच्या कारणांसह कोणतेही विशेष अभिप्राय:.....  
अटकपुर्व जामिन अर्ज मा. उच्च न्यायालयात प्रलंबीत, मा. उच्च न्यायालयाकडून प्राप्त  
आदेशान्वये पुढील कारवाई करून तिचे विरुद्ध पुरवणी दोषारोपपत्र सादर करण्याची  
तजविज ठेवली आहे.

(G.C.P.) K 2297

Form:5-C

11. Particulars of Wanted accused persons:-

पाहीजे आरोपीचा तपशील (प्रत्येक आरोपीसाठी स्वतंत्र कागद वापरावा)

- (1) \*Name: समीक्षा गिरीष अगरवाल  
नांव  
Whether verified:.....  
पडताळले किंवा कार्य
- (2) Father's/Husband's Name:.....  
पित्याचे/पतीचे नांव
- (3) Date/Year of Birth (जन्मतारीख / वर्ष):.....
- (4) Sex:..... स्त्री.....  
लिंग  
(5) Nationality:..... भारतीय.....  
राष्ट्रीयत्व
- (6) Passport No:.....Date of Issue:.....Place of Issue:.....  
पारपत्र क्र. दिल्याची तारीख दिल्याचे ठिकाण
- (7) Religion:..... (8) Whether SC/ST:.....  
धर्म अनुसुचित जातीचा/जमातीचा आहे का
- (9) Occupation (व्यवसाय): .....
- (10) Address (पत्ता ए-४० केवल कुंज अपार्टमेंट, सेक्टर-१३, रोहीणी,  
डी.डी. क्लब जवळ, दिल्ली-११००८५
- (11) Whether verified (पडताळला किंवा काय):.....
- (12) \*Provisional Criminal No (तात्पुरता गुन्हेगार क्र.):... ०३.....
- (13) \*Suspicion Approved (संशय खरा ठरला काय): Yes/No (होय/नाही):.....
- (14) \*Status of the accused (suspect) आरोपीची स्थिती (संशयित):  
Bailed by Police/Bailed by Court/in Judicial Custody/Absconding/  
Proclaimed offender/Not arrested:  
पोलीसांनी जामीनावर सोडले/न्यायालयाने जामीनावर सोडले/न्यायालयीन कोठडी/फरारी/उदाघोषित अपराधी/मिळून आला नाही  
.....मिळून आली नाही.....
- (15) \*Under Acts& Sections: ..  
कोणत्या अधिनियमाखाली व कलमाखाली  
Any special remarks including reasons for not charge sheeting:  
आरोपपत्र न ठेवण्याच्या कारणांसह कोणतेही विशेष अभिप्राय:.....  
अटकपूर्व जामिन अर्ज मा. उच्च न्यायालयात प्रलंबीत, मा. उच्च न्यायालयाकडून प्राप्त  
आदेशान्वये पुढील कारवाई करून तिचे विरुद्ध पुरवणी दोषारोपपत्र सादर करण्याची  
तजविज ठेवली आहे.

(G.C.P.) K 2297

Form:5-C

11. Particulars of Wanted accused persons:-

पाहीजे आरोपीचा तपशील (प्रत्येक आरोपीसाठी स्वतंत्र कागद वापरावा)

- (1) \*Name: पिंगी जगदीशप्रसाद अगरवाल  
नांव
- (2) Father`s/Husband`s Name:.....  
पित्याचे/पतीचे नांव
- (3) Date/Year of Birth (जन्मतारीख/वर्ष):.....
- (4) Sex:..... स्त्री..... (5) Nationality:.... भारतीय.....  
लिंग राष्ट्रीयत्व
- (6) Passport No:.....Date of Issue:.....Place of Issue:.....  
पारपत्र क्र. दिल्याची तारीख दिल्याचे ठिकाण
- (7) Religion:.... (8) Whether SC/ST:.....  
धर्म अनुसुचित जातीचा/जमातीचा आहे का
- (9) Occupation (व्यवसाय): .....
- (10) Address (पत्ता ए-४० केवल कुंज अपार्टमेंट, सेक्टर-१३, रोहीणी,  
डी.डी. क्लब जवळ, दिल्ली-११००८५
- (11) Whether verified (पडताळला किंचा काय):.....
- (12) \*Provisional Criminal No (तात्पुरता गुन्हेगार क्र.):... ०४.....
- (13) \*Suspicion Approved (संशय खरा ठरला काय):Yes/No (होय/नाही):.....
- (14) \*Status of the accused (suspect) आरोपीची स्थिती (संशयित):  
Bailed by Police/Bailed by Court/in Judicial Custody/Absconding/  
Proclaimed offender/Not arrested:  
पोलीसांनी जामीनावर सोडले/न्यायालयाने जामीनावर सोडले/न्यायालयीन कोठडी/फरारी/उद!घोषित अपराधी/मिळून आला नाही  
.....मिळून आली नाही.....
- (15) \*Under Acts& Sections: ..  
कोणत्या अधिनियमाखाली व कलमाखाली  
Any special remarks including reasons for not charge sheeting:  
आरोपपत्र न ठेवण्याच्या कारणांसह कोणतेही विशेष अभिप्राय:.....  
अटकपूर्व जामिन अर्ज मा. उच्च न्यायालयात प्रलंबीत, मा. उच्च न्यायालयाकडून प्राप्त  
आदेशान्वये पुढील कारवाई करून त्याचे विरुद्ध पुरवणी दोषारोपपत्र सादर करण्याची  
तजविज ठेवली आहे.

11. Particulars of Wanted accused persons:-

पाहीजे आरोपीचा तपशील (प्रत्येक आरोपीसाठी स्वतंत्र कागद वापरावा)

(1) \*Name: स्नेहा बबन चव्हाण  
नांव

Whether verified:.....  
पडताळले किंवा कार्य

(2) Father's/Husband's Name:.....  
पित्याचे/पतीचे नांव

(3) Date/Year of Birth (जन्मतारीख/वर्ष):.....

(4) Sex:..... स्त्री.....  
लिंग

(5) Nationality:.... भारतीय.....  
राष्ट्रीयत्व

(6) Passport No:..... Date of Issue:..... Place of Issue:.....  
पारपत्र क्र. दिल्याची तारीख दिल्याचे ठिकाण

(7) Religion:.... धर्म (8) Whether SC/ST:.....  
अनुसुचित जातीचा/जमातीचा आहे का

(9) Occupation (व्यवसाय): .....

(10) Address (पत्ता चव्हाण हाऊस, मरोळ मरोशी रोड, आय.सी.आय.सी.आय बँक,  
लोकदर्शन समोर, अंधेरी (पुर्व), मुंबई-४०००५९

(11) Whether verified (पडताळला किंवा काय):.....

(12) \*Provisional Criminal No (तात्पुरता गुन्हेगार क्र.):... ०५.....

(13) \*Suspicion Approved (संशय खरा ठरला काय):Yes/No (होय/नाही):.....

(14) \*Status of the accused (suspect) आरोपीची स्थिती (संशयित):

Bailed by Police/Bailed by Court/in Judicial Custody/Absconding/

Proclaimed offender/Not arrested:

पोलीसांनी जामीनावर सोडले/न्यायालयाने जामीनावर सोडले/न्यायालयीन कोठडी/फरारी/उदघोषित अपराधी/मिळून आला नाही  
.....मिळून आली नाही.....

(15) \*Under Acts& Sections: ..

कोणत्या अधिनियमाखाली व कलमाखाली

Any special remarks including reasons for not charge sheeting:

आरोपपत्र न ठेवण्याच्या कारणांसह कोणतेही विशेष अभिप्राय:.....

अटकपुर्व जांमिन अर्ज मा. उच्च न्यायालयात प्रलंबीत, मा. उच्च न्यायालयाकडून प्राप्त  
आदेशान्वये पुढील कारवाई करून त्याचे विरुद्ध पुरवणी दोषारोपपत्र सादर करण्याची  
तजविज ठेवली आहे.

## 11. Particulars of Wanted accused persons:-

पाहीजे आरोपीचा तपशील (प्रत्येक आरोपीसाठी स्वतंत्र कागद वापरावा)

- (1) \*Name: अतुल सुरेद्र पांडे  
नांव  
Whether verified:.....  
पडताळले किंवा कार्य
- (2) Father's/Husband's Name:.....  
पित्याचे/पतीचे नांव
- (3) Date/Year of Birth (जन्मतारीख/वर्ष):.....
- (4) Sex:..... पुरुष.....  
लिंग  
(5) Nationality:.... भारतीय.....  
राष्ट्रीयत्व
- (6) Passport No:.....Date of Issue:.....Place of Issue:.....  
पारपत्र क्र. दिल्याची तारीख दिल्याचे ठिकाण
- (7) Religion:....  
धर्म  
(8) Whether SC/ST:.....  
अनुसुचित जातीचा/जमातीचा आहे का
- (9) Occupation (व्यवसाय): .....
- (10) Address (पत्ता फ्लॉट नंबर ७, योगेद्र भवन, जे.बी. नगर, बगाडका कॉलेज जवळ,  
अंधेरी (पूर्व), मुंबई-४०००५९
- (11) Whether verified (पडताळला किंवा काय):.....
- (12) \*Provisional Criminal No (तात्पुरता गुन्हेगार क्र.):... ०६.....
- (13) \*Suspicion Approved (संशय खरा ठरला काय):Yes/No (होय/नाही):.....
- (14) \*Status of the accused (suspect) आरोपीची स्थिती (संशयीत):  
Bailed by Police/Bailed by Court/in Judicial Custody/Absconding/  
Proclaimed offender/Not arrested:  
पोलीसांनी जामीनावर सोडले/न्यायालयाने जामीनावर सोडले/न्यायालयीन कोठडी/फरारी/उदधोषित अपराधी/मिळून आला नाही  
.....मिळून आलेला नाही.....
- (15) \*Under Acts& Sections: ..  
कोणत्या अधिनियमाखाली व कलमाखाली  
Any special remarks including reasons for not charge sheeting:  
आरोपपत्र न ठेवण्याच्या कारणांसह कोणतेही विशेष अभिप्राय:.....  
अटकपूर्व जामिन अर्ज मा. उच्च न्यायालयात प्रलंबीत, मा. उच्च न्यायालयाकडून प्राप्त  
आदेशान्वये पुढील कारवाई करून त्याचे विरुद्ध पुरवणी दोषारोपपत्र सादर करण्याची  
तजविज ठेवली आहे.

## 11. Particulars of Wanted accused persons:-

पाहीजे आरोपीचा तपशील (प्रत्येक आरोपीसाठी स्वतंत्र कागद वापरावा)

- (1) \*Name: रजनी सुरेद्र पांडे  
नांव
- (2) Father's/Husband's Name:.....  
पित्याचे/पतीचे नांव
- (3) Date/Year of Birth (जन्मतारीख/वर्ष):.....
- (4) Sex:..... पुरुष.....  
लिंग
- (5) Nationality:.... भारतीय.....  
राष्ट्रीयत्व
- (6) Passport No:.....Date of Issue:.....Place of Issue:.....  
पारपत्र क्र. दिल्याची तारीख दिल्याचे ठिकाण
- (7) Religion:....  
धर्म
- (8) Whether SC/ST:.....  
अनुसुचित जातीचा/जमातीचा आहे का
- (9) Occupation (व्यवसाय): .....
- (10) Address (पत्ता फ्लॅट नंबर ७, योगेद्र भवन, जे.बी. नगर, बगाडका कॉलेज जवळ,  
अंधेरी (पुर्व), मुंबई-४०००५९
- (11) Whether verified (पडताळला किंचा काय):.....
- (12) \*Provisional Criminal No (तात्पुरता गुन्हेगार क्र.):... ०७.....
- (13) \*Suspicion Approved (संशय खरा ठरला काय):Yes/No (होय/नाही):.....
- (14) \*Status of the accused (suspect) आरोपीची स्थिती (संशयीत):  
Bailed by Police/Bailed by Court/in Judicial Custody/Absconding/  
Proclaimed offender/Not arrested:  
पोलीसांनी जामीनावर सोडले/न्यायालयाने जामीनावर सोडले/न्यायालयीन कोठडी/फरारी/उदघोषित अपराधी/मिळून आला ना  
.....मिळून आली नाही.....
- (15) \*Under Acts& Sections: ..  
कोणत्या अधिनियमाखाली व कलमाखाली  
Any special remarks including reasons for not charge sheeting:  
आरोपपत्र न ठेवण्याच्या कारणांसह कोणतेही विशेष अभिप्राय:.....  
अटकपुर्व जांमिन अर्ज मा. उच्च न्यायालयात प्रलंबीत, मा. उच्च न्यायालयाकडून प्राप्त  
आदेशान्वये पुढील कारवाई करून त्याचे विरुद्ध पुरवणी दोषारोपपत्र सादर करण्याची  
तजविज ठेवली आहे.

## 11. Particulars of Wanted accused persons:-

पाहीजे आरोपीचा तपशील (प्रत्येक आरोपीसाठी स्वतंत्र कागद वापरावा)

- (1) \*Name: राजेश भगवानदास अगरवाल  
नांव  
Whether verified:.....  
पडताळले किंवा कार्य
- (2) Father's/Husband's Name:.....  
पित्याचे/पतीचे नांव
- (3) Date/Year of Birth (जन्मतारीख/वर्ष):.....
- (4) Sex:..... पुरुष..... (5) Nationality:... भारतीय.....  
लिंग राष्ट्रीयत्व
- (6) Passport No:.....Date of Issue:.....Place of Issue:.....  
पारपत्र क्र. दिल्याची तारीख दिल्याचे ठिकाण
- (7) Religion:..... (8) Whether SC/ST:.....  
धर्म अनुसुचित जातीचा/जमातीचा आहे का
- (9) Occupation (व्यवसाय): .....
- (10) Address (पत्ता १/बी-१०८ वालचंद जोत को ऑ हौ सोसायटी, पोष्ट ऑफिस जवळ,  
पाठक रोड, भाईंदर (प), ठाणे, महाराष्ट्र-४०११०१
- (11) Whether verified (पडताळला किंचा काय):.....
- (12) \*Provisional Criminal No (तात्पुरता गुन्हेगार क्र.):... ०८.....
- (13) \*Suspicion Approved (संशय खरा ठरला काय): Yes/No (होय/नाही):.....
- (14) \*Status of the accused (suspect) आरोपीची स्थिती (संशयित):  
Bailed by Police/Bailed by Court/in Judicial Custody/Absconding/  
Proclaimed offender/Not arrested:  
पोलीसांनी जामीनावर सोडले/न्यायालयाने जामीनावर सोडले/न्यायालयीन कोठडी/फरारी/उदघोषित अपराधी/मिळून आला नाही  
.....मिळून आलेला नाही.....
- (15) \*Under Acts& Sections: ..  
कोणत्या अधिनियमाखाली व कलमाखाली  
Any special remarks including reasons for not charge sheeting:  
आरोपपत्र न ठेवण्याच्या कारणांसह कोणतेही विशेष अभिप्राय:.....  
अटकपुर्व जामिन अर्ज मा. उच्च न्यायालयात प्रलंबीत, मा. उच्च न्यायालयाकडून प्राप्त  
आदेशान्वये पुढील कारवाई करून त्याचे विरुद्ध पुरवणी दोषारोपपत्र सादर करण्याची  
तजविज ठेवली आहे.

(G.C.P.) K 2297

Form:5-C

11. Particulars of Wanted accused persons:-

पाहीजे आरोपीचा तपशील (प्रत्येक आरोपीसाठी स्वतंत्र कागद वापरावा)

- (1) \*Name: कमलेश भैरवा तातावत  
नांव
- (2) Father's/Husband's Name:.....  
पित्याचे/पतीचे नांव
- (3) Date/Year of Birth (जन्मतारीख/वर्ष):.....
- (4) Sex:..... पुरुष.....  
लिंग
- (5) Nationality:.... भारतीय.....  
राष्ट्रीयत्व
- (6) Passport No:.....Date of Issue:.....Place of Issue:.....  
पारपत्र क्र. दिल्याची तारीख दिल्याचे ठिकाण
- (7) Religion:.... धर्म
- (8) Whether SC/ST:.....  
अनुसूचित जातीचा/जमातीचा आहे का
- (9) Occupation (व्यवसाय): .....
- (10) Address (पत्ता) ८९डी, नारायण विहार-१, जगन्नाथपुरा, संगानेर, जयपुर, राजस्थान
- (11) Whether verified (पडताळला किंचा काय):.....
- (12) \*Provisional Criminal No (तात्पुरता गुन्हेगार क्र.):... ०९.....
- (13) \*Suspicion Approved (संशय खरा ठरला काय):Yes/No (होय/नाही):.....
- (14) \*Status of the accused (suspect) आरोपीची स्थिती (संशयांत):  
Bailed by Police/Bailed by Court/in Judicial Custody/Absconding/  
Proclaimed offender/Not arrested:  
पोलीसांनी जामीनावर सोडले/न्यायालयाने जामीनावर सोडले/न्यायालयीन कोठडी/फरारी/उद!घोषित अपराधी/मिळून आला नाही  
.....मिळून आलेला नाही.....
- (15) \*Under Acts& Sections: ..  
कोणत्या अधिनियमाखाली व कलमाखाली  
Any special remarks including reasons for not charge sheeting:  
आरोपपत्र न ठेवण्याच्या कारणांसह कोणतेही विशेष अभिप्राय:.....  
अटकपुर्व जामिन अर्ज मा. उच्च न्यायालयात प्रलंबीत, मा. उच्च न्यायालयाकडून प्राप्त  
आदेशान्वये पुढील कारवाई करून त्याचे विरुद्ध पुरवणी दोषारोपपत्र सादर करण्याची  
तजविज ठेवली आहे.

(G.C.P.) K 2297

Form:5-D

12. Particulars of witnesses to be examined: (पडताळलेल्या साक्षीदारांचे विवरण)

Sr.No. अ.क्र.	Name नांव	Father's/Husband's Name पित्याचे/पतीचे नांव	Date/Year of Birth जन्मतारीख/वर्ष	Occupation व्यवसाय	Address पत्ता	Type of evidence to be tendered सादर करावयाच्या पुराव्याचा प्रकार
1	2	3	4	5	6	7
१)	श्री. अमित कमल अगरवाल, वय ३४ वर्षे, रा.टी ९०१ बिकानेर भवन, जे.बी. नगर, अंधेरी (पूर्व), मुंबई					--- फियादी
२)	श्री. गिरीष गोपालदास मुंदडा, वय ३५ वर्षे, रा.टी. ब्रिज अपार्टमेंट, प्लॉट ६३, प्रोजेन मॉल, सिडको एन-१, छत्रपती संभाजी नगर---					साक्षीदार
३)	श्री. संदीप लक्ष्मण शिंदे, सहाय्यक पो. निरीक्षक, सहार पोलीस ठाणे, मुंबई					--- तपास अधिकारी

13.

**IF F.I.R. is False, indicate action taken or proposed to be taken u/s 182/211 I.P.C.**.....

पहिली खबर खोबी असेल तर भारतीय दंड संहितेच्या १८२/२११ अन्वये केलेली किंवा करावयाची नमुद करावी.

14.

**Result of laboratory analysis:**.....

प्रयोगशाळा विश्लेषणाचे निष्कर्ष:

## 16. \* Brief fact of the case (Add separate sheet, if necessary):

प्रकरणाची थोडक्यात माहिती (आवश्यक असल्यास वेगळा कागद जोडावा)

फिर्यादी श्री. अमीत कमल अगरवाल, वय ३४ वर्षे याचे वडील श्री. कमल अगरवाल यांनी सन-२००८ मध्ये सुप्रिम ट्रान्सपोर्ट प्रा लि नावाची कंपनी सुरु केलेली आहे. तर फिर्यादी यांनी संगीता एव्हिएशन सर्विस प्रा लि कंपनीची स्थापना सन-२०१२ मध्ये केलेली आहे. या दोन्ही कंपन्यामध्ये फिर्यादी हे अध्यक्ष आणि कार्यकारी संचालक म्हणून सध्या कार्यरत आहेत. दोन्ही कंपनीचे ऑफिस पत्ता - ५/बी-३४, ५/बी-३२ अक्षय मित्तल इंडस्ट्रीयल इस्टेट, अंधेरी कुर्ला रोड, अंधेरी (पुर्व), मुंबई या ठिकाणी आहे.

सुप्रिम ट्रान्सपोर्ट प्रा. लि या कंपनीमध्ये फिर्यादी हे स्वतः, तसेच त्यांचे वडील श्री. कमल अगरवाल, सख्खा धाकटा भाऊ आकाश अगरवाल आणि आरोपी विमल अगरवाल व गिरीष अगरवाल असे एकुण ०५ संचालक आहेत. सदर कंपनीचा मुख्य व्यवसाय मालाची रस्ते वाहतुक आणि हवाई वाहतुक करण्याचा आहे. कंपनीच्या मालकीची काही वाहने व विमान आहेत. या व्यतीरीक्त कंपनीच्या व्यवसायाकरीता आवश्यकते नुसार भाडे तत्वावर वाहने घेतली जातात. सदर कंपनीचे मुख्य कार्यालय मुंबईमध्ये असून पनवेल, कळंबोली, राजस्थान, गुजरात, दिल्ली आणि बेंगलोर या ठिकाणी शाखा व विभागीय कार्यालये आहेत.

संचालकांपैकी आरोपी विमल अगरवाल हे बेंगलोर येथे रहावयास आहेत तर संचालक गिरीष अगरवाल हे दिल्ली येथे रहावयास आहेत. ते दोघेही नात्याने फिर्यादी यांचे चुलतभाऊ आहेत. त्यांचे दिवंगत वडील कै. जगदीशप्रसाद अगरवाल हे फिर्यादी यांच्या वडीलांचे सख्खे मोठे भाऊ होते. कै. जगदीशप्रसाद अगरवाल यांच्या मृत्यु नंतर विमल अगरवाल आणि गिरीष अगरवाल यांची परस्परातील सहमती नुसार सुप्रिम ट्रान्सपोर्ट कंपनीमध्ये संचालक म्हणून नियुक्ती करण्यात आली आहे. ते दोघेही प्रत्येक महीन्यातील काही दिवस मुंबईमध्ये राहून कंपनीच्या दैनंदिन कामकाजात सहभागी होत असत.

सुप्रिम ट्रान्सपोर्ट प्रा लि. ही कंपनी तोटयात व्यवसाय करित असल्यामुळे सन-२०१२ साली अगरवाल कुटुंबातील समझौत्या नुसार फिर्यादी यांची सदर कंपनीमध्ये कार्यकारी संचालक आणि अध्यक्ष म्हणून नेमणुक करण्यात आली आहे. तेव्हापासून दोन्ही कंपनीचा व्यवसाय एकत्रीतरित्या वर नमुद पत्त्यावरील कंपनीच्या कार्यालयातून फिर्यादी यांच्या देखरेखीखाली करण्यात येत आहे. संगीता एव्हिएशन या कंपनीच्या विरूध्द थकबाकी देय असल्याकारणाने एका कंपनीने एन.सी. एल.टी. येथे इन्सॉल्व्हन्सी पीटीशन दाखल केले होते. त्यानुसार मा. एन.सी.एल.टी. प्राधिकरणाने संगीता एव्हिएशन या कंपनीस दिनांक १०/०८/२०२१ रोजी दिवाळखोर म्हणून घोषित केले आहे. त्याविरूध्द कंपनीच्या वतीने अपीलिय प्राधिकरणाकडे दाद मागण्यात आली असून त्याची सुनावणी चालू आहे. त्यामुळे संगीता एव्हिएशन या कंपनीच्या सर्व आर्थिक व्यवहारांवर मा. एन.सी.एल.टी. प्राधिकरणाने नेमलेले आय. आर. पी. श्री बिजेंद्र झा यांची देखरेख आहे.

सन-२०१४ मध्ये फिर्यादी यांच्या कंपनीमध्ये आरोपी वरुण रमेश काकरीया, रा.टी. बि विंग, शरयु बिल्डींग, सुचीधाम, फिल्म सिटी रोड, मालाड (पुर्व), मुंबई याची नेमणुक सदर कंपनीमध्ये सहाय्यक म्हणून करण्यात आली होती.

(G.C.P) K2297D

Form: 5-E

16. \* Brief fact of the case (Add separate sheet, if necessary):

प्रकरणाची थोडक्यात माहिती (आवश्यक असल्यास वेगळा कागद जोडावा)

सन-२०१६ साली फिर्यादी यांच्या कंपनीमध्ये आरोपी कमलेश भैरव-तातावत, रा.ठी. ८९/डी, नारायण विहार-१, जगन्नाथपुर, संगानेर, जयपुर, राजस्थान याची चिफ फायनान्स ऑफिसर (सी.एफ.ओ.) म्हणून नियुक्ती केली होती. तसेच त्याचा चुलतभाऊ मुकेश भैरव तातावत याची नियुक्ती चिफ ऑपरेशन ऑफिसर म्हणून केली होती.

दोन्ही कंपन्या वेळोवेळी सरकारच्या विविध खात्यातर्फे जाहीर करण्यात आलेल्या प्रकल्पात ठेकदार म्हणून सहभागी होत असतात. सदर कंत्राट मिळविण्या करिता करावयाची संपुर्ण प्रक्रीया, त्या करिता आवश्यक असलेले सर्व कागदोपत्री व्यवहार, वेळोवेळी संबधीत सरकारी अधिकाऱ्यांसमवेत संपर्क ठेवणे, कंत्राट पुर्ण करण्याकरिता विविध व्यवसायीकांची मदत घेणे, कंत्राटप्रमाणे नेमुन दिलेले काम पुर्ण करणे, सरकारी कार्यालयातुन येणे असलेल्या रकमेचा पाठपुरावा करणे, कंपनी तर्फे विविध व्यवसायीकांना देय असलेली रक्कम अदा करणे इत्यादी अनेक कार्य व्यवसायानिमित्त करावी लागतात. या सर्व कामाची जबाबदारी कमलेश तातावत आणि वरुण काकरीया यांच्यावर सोपविण्यात आली होती, त्या प्रमाणे ते दोघेजण कंपनीतील कामकाज करित होते.

फिर्यादीचे पुर्वीचे मित्र स्वप्नील चव्हाण आणि अतुल पांडे हे सुध्दा वर नमुद पत्त्यावरील कंपनीच्या कार्यालयात नेहमी येत-जात होते. दोन्ही कंपनीचे एच. डी.एफ.सी बँक, बँक ऑफ इंडिया, पंजाब नॅशनल बँक, सिटी बँक, डी.सी.बी बँक इत्यादी बँकेमध्ये खाते आहेत. सदर बँक खात्याचा तपशील खालील प्रमाणे आहे.

	Bank Name	Account Number
M/s Supreme Transport Origination Pvt. Limited	HDFC	10452840000014
	HDFC	03302840000157
	HDFC	01662840000470
	HDFC	03302840000140
	HDFC	04072840000053
	HDFC	00602340000085
	PNB	10451131002901
	BOI	843720110000498
	BOI	004420110000823

	Bank Name	Account Number
M/s Sangeeta Aviation Services Pvt. Ltd	Development Credit Bank (Customer ID 102173678)	00421300002745
	HDFC	50200008133578
	Citi Bank	0060246114
	Punjab National Bank	10454015001858

तसेच कंपनीच्या व्यवहारातील सुलभते करीता फिर्दा यांचे व्यक्तीगत बँक खाती देखील कंपनीच्या कार्यालयातून वेळोवेळी वापरण्यात येत असतात. फिर्दा यांच्या वैयक्तिक बँक खात्याचा तपशील खालील प्रमाणे

	Bank Name	Account Number
Mr. Ammeet K. Agarwal	Development Credit Bank	00410200001403
	PNB	10452191004874

वर नमुद केलेली सर्व बँक खाती व्यवहारीक सुलभते करीता नेट बँकींगच्या माध्यमातून वापरली जातात. उपरोक्त बँक खात्यापैकी सुप्रिम ट्रान्सपोर्ट प्रा लि कंपनीच्या HDFC बँकेतील सर्व खात्यांचा रजिस्टर्ड ईमेल आयडी girish@stopl.in आणि रजिस्टर्ड मोबाईल क्रमांक 9311701121 असा असून सदरचा ईमेल आय डी आणि मोबाईल नंबर श्री. गिरीष अगरवाल यांच्या व्यक्तीगत वापरात आहे. तसेच इतर सर्व बँक खात्याचा रजिस्टर्ड ईमेल आय.डी. kamlesh@supremeavaiation.com आणि रजिस्टर्ड मोबाईल नंबर 8078655144 असा असून तो कमलेश तातावत यांच्या व्यक्तीगत वापरात आहे.

फिर्दा यांना कंपनीच्या कामासाठी सतत पदेशात तसेच भारतातील विविध भागात जावे लागते, त्यामुळे फिर्दास कंपनीच्या दैनंदिन आर्थिक व्यवहाराचे कामकाज पाहणे शक्य नसल्यामुळे त्यांनी दोन्ही कंपनीच्या सर्व आर्थिक व्यवहाराची तसेच फिर्दा यांच्या वैयक्तिक बँक खात्यातील ऑनलाईन/ऑफलाईन व्यवहाराची संपुर्ण जबाबदारी सी.एफ.ओ कमलेश तातावत यांच्यावर सोपवली होती. तसेच कमलेश तातावत याला कंपनीच्या कामकाजा करीता एक स्वतंत्र लॅपटॉप आणि संगणक देण्यात आलेला होता.

फिर्दा, जुलै-२०२२ मध्ये कंपनीच्या आर्थिक व्यवहाराचा आढावा घेत असताना त्यांना काही माहिती आवश्यक असल्याने त्यांनी कमलेश आणि वरुण यांना कंपनीला येणे असलेल्या रकमेचा तपशील मागीतला होता. त्यावेळी निष्पॉन लिमिटेड कंपनीकडून काही रक्कम येणे बाकी असल्याचे समजले. त्यामुळे फिर्दा यांनी स्वतः जुलै ते सप्टेंबर-२०२२ मध्ये निष्पॉन कंपनीच्या संबंधित अधिकाऱ्यांना अनेकवेळा ईमेल पाठवून कंपनीची देय असलेली रक्कम लवकरात लवकर अदा करावी अशी विनंती केली होती. बऱ्याच प्रयत्नानंतर दिनांक २६/०८/२०२२ रोजी निष्पॉन लिमिटेड कंपनीच्या पदाधिकाऱ्यांनी फिर्दा यांना ईमेल पाठवून फिर्दा यांच्या कंपनीला देय असलेली रक्कम कंपनीच्या BOI A/C No 843720110000498 मध्ये ट्रान्सफर केली असल्याचे कळविले होते.

फिर्दा यांनी नमुद BOI बँक खात्याचे स्टेटमेंट प्राप्त करून त्याचे अवलोकन केले असता दिनांक २६/०७/२०२२ रोजी निष्पॉन लिमिटेड कंपनीकडून एकुण ०३,२२,६१६/- एवढी रक्कम प्राप्त झाली असल्याचे आढळून आले. परंतु दिनांक २७/०७/२०२२ रोजी एकुण ०३,२३,२७८/- एवढी रक्कम कंपनीचे संचालक विमल अगरवाल यांच्या बँक खात्यामध्ये ट्रान्सफर करण्यात आली असल्याचे आढळून आले.

## 16. \* Brief fact of the case (Add separate sheet, if necessary):

प्रकरणाची थोडक्यात माहिती (आवश्यक असल्यास वेगळा कागद जोडावा)

सदर वेळी फिर्यादी परदेशात असल्यामुळे त्यांनी सी.एफ.ओ. श्री. कमलेश तातावत यांच्याशी संपर्क साधून त्यांच्याकडे विमल अगरवाल यांना दिनांक २७/०७/२०२२ रोजी करण्यात आलेल्या पेमेंट बाबत विचारणा केली, परंतु त्याने काणेतीही समाधानकारक माहिती दिली नाही.

सबब फिर्यादी यांनी विलम अगरवाल यांच्याशी संपर्क केला परंतु त्याने फिर्यादी यांना कोणतीही समाधान कारक माहिती दिली नाही. त्यानंतर कमलेश तातावत आणि वरुण काकरीया यांनी अचानक कंपनीच्या ऑफिसमध्ये येणे बंद केले.

विमल अगरवाल व कमलेश तातावत यांच्या एकंदरीत वर्तणुकीवरून त्यांनी कंपनीमध्ये काहीतरी आर्थिक गैरव्यवहार केला असावा अशी शंका आल्यामुळे फिर्यादी यांनी परदेशातून भारतात आल्यानंतर कंपनीचे चार्टर्ड अकाऊंटंट श्री. गिरीष मुंदडा यांना दिनांक ०६/०९/२०२२ रोजी लेखी पत्र पाठवून कंपनीच्या बँक खात्याची तसेच आर्थिक व्यवहाराची चौकशी/छाननी करून त्याबाबतचा त्यांचा निष्कर्ष कळविण्याची विनंती केली होती. त्या प्रमाणे त्यांनी फिर्यादीच्या कंपनीच्या आर्थिक व्यवहाराची तपासणी करून त्यांचा अहवाल दिनांक ०२/०३/२०२३ रोजी दिला आहे.

सुप्रीम ट्रान्सपोर्ट, संगीता एव्हीएशन आणि फिर्यादी यांच्या वैयक्तिक बँक खात्याची माहिती (उपरोक्त नमुद) व संबंधीत खात्यांचे बँक स्टेटमेंट प्राप्त करून त्याचे अवलोकन केले असता भाडे आणि वेतनाच्या नावाखाली सुप्रीम ट्रान्सपोर्ट कंपनी व संगीता एव्हीएशन या कंपन्यांच्या बँक खात्यांतून आणि फिर्यादीच्या वैयक्तिक बँक खात्यांतून खालील व्यक्तींच्या बँक खात्यांमध्ये एकुण ६,२७,३६,१८०/- एवढी रक्कम ट्रान्सफर झाली असल्याचे आढळून आले. सदर व्यक्तीची नावे व त्यांच्या बँक खात्याची माहिती खालील प्रमाणे आहे.

१) आरोपी विमल अगरवाल यांचे HDFC Bank A/c No 02721000019875 या खात्यामध्ये दिनांक ०३/०४/२०१८ ते दिनांक ०९/०७/२०२२ या कालावधीत सुप्रीम ट्रान्सपोर्ट कंपनीच्या खात्यातून एकुण रक्कम रू. १,८६,२६,९०८ , संगीता एव्हीएशन कंपनीच्या खात्यातून एकुण रक्कम रू. १३,९३,२५० आणि अमित अगरवाल यांच्या खात्यातून रू. ८,००,००० अशी एकत्रित ०२,०८,२०,१५८/- इतकी रक्कम ट्रान्सफर करण्यात आली आहे.

२) श्रीमती नुपुर विमल अगरवाल यांचे HDFC Bank A/c No 02721000018984 या खात्यामध्ये दिनांक १६/०१/२०१८ ते दिनांक ०६/०७/२०२२ या कालावधीत सुप्रीम ट्रान्सपोर्ट कंपनीच्या खात्यातून एकुण रक्कम रू. २२,१४,८२४ , संगीता एव्हीएशन कंपनीच्या खात्यातून एकुण रक्कम रू. ८,१७,६०० आणि अमित अगरवाल यांच्या खात्यातून रू. ८,००,००० अशी एकत्रित ३८,३२,४२४/- इतकी रक्कम ट्रान्सफर करण्यात आली आहे.

३) गिरीष जगदीशप्रसाद अगरवाल यांचे HDFC Bank A/c No 02721000019892 या खात्यामध्ये दिनांक २२/०६/२०१८ ते दिनांक ०६/०७/२०२२ या कालावधीत

सुप्रिम ट्रान्सपोर्ट कंपनीच्या खात्यातुन एकुण रक्कम रू. ११,०५,०७२ , संगीता एव्हीएशन कंपनीच्या खात्यातुन एकुण रक्कम रू. १३,९३,२५० आणि अमित अगरवाल यांच्या खात्यातुन रू. ८,००,००० अशी एकत्रित ३२,९८,३३२/- इतकी रक्कम ट्रान्सफर करण्यात आली आहे.

४) श्रीमती समीक्षा गिरीष अगरवाल यांचे HDFC Bank A/c No 02721000070214 या खात्यामध्ये दिनांक २२/०६/२०१८ ते दिनांक ०६/०७/२०२२ या कालावधीत सुप्रिम ट्रान्सपोर्ट कंपनीच्या खात्यातुन एकुण रक्कम रू. ०८,७९,९७० , संगीता एव्हीएशन कंपनीच्या खात्यातुन एकुण रक्कम रू. १०,९५,५०० आणि अमित अगरवाल यांच्या खात्यातुन रू. ८,००,००० अशी एकत्रित २७,७५,४७०/- इतकी रक्कम ट्रान्सफर करण्यात आली आहे.

५) श्रीमती पिकी जगदीशप्रसाद अगरवाल यांचे HDFC Bank A/c No 02721000055437 या खात्यामध्ये दिनांक ०४/०५/२०१८ ते दिनांक ०६/०७/२०२२ या कालावधीत सुप्रिम ट्रान्सपोर्ट कंपनीच्या खात्यातुन एकुण रक्कम रू. ११,९४,९७० , संगीता एव्हीएशन कंपनीच्या खात्यातुन एकुण रक्कम रू. ८,७७,१५० आणि अमित अगरवाल यांच्या खात्यातुन रू. ७,८६,६११ अशी एकत्रित २८,५८,७००/- इतकी रक्कम ट्रान्सफर करण्यात आली आहे.

६) अतुल सुरेद्र पांडे यांचे HDFC Bank A/c No 12111140000459 या खात्यामध्ये दिनांक ३१/०८/२०१९ ते दिनांक १५/१२/२०२१ या कालावधीत एकुण 37,34,000/- इतकी रक्कम संगीता एव्हीएशन या कंपनीच्या बँक खात्यातुन ट्रान्सफर करण्यात आली आहे.

७) श्रीमती रजनी सुरेद्र पांडे यांचे PNB Bank A/c No 1565000100131966 या खात्यामध्ये दिनांक ०९/१०/२०२० ते दिनांक ०५/१२/२०२० या कालावधीत एकुण 11,00,000/- इतकी रक्कम संगीता एव्हीएशन या कंपनीच्या बँक खात्यातुन ट्रान्सफर झाले आहेत.

८) स्वप्नील बबन चव्हाण यांचे ICICI Bank A/c No 104401531869 & Axis Bank A/c No 921010008877100 या खात्यामध्ये दिनांक १५/११/२०१९ ते दिनांक २७/१२/२०२१ या कालावधीत एकुण 45,52,400/- इतकी रक्कम संगीता एव्हीएशन या कंपनीच्या बँक खात्यातुन ट्रान्सफर करण्यात आली आहे.

९) श्रीमती स्नेहा बबन चव्हाण यांचे Saraswat Bank A/c No 013200128873557 या खात्यामध्ये दिनांक ०४/०७/२०१९ ते दिनांक ०७/०९/२०२१ या कालावधीत एकुण 47,55,000/- इतकी रक्कम संगीता एव्हीएशन या कंपनीच्या बँक खात्यातुन ट्रान्सफर करण्यात आली आहे.

१०) तसेच स्वप्नील चव्हाण याने दिनांक ०५/०३/२०१७ रोजी UAE देशात "पोटोमॅक एव्हीएशन टेक्नॉलाजी" नावाची कंपनी स्थापन केली आहे. तसेच सदर कंपनीच्या "नुर ट्रेड बँक, यु.ए.ई" येथे बँक खाते उघडले असून सदर बँक खात्याचा पत्ता मरोळ मरोशी रोड, अंधेरी (पुर्व), मुंबई येथील आहे. तसेच सुप्रिम एव्हीएशन कंपनीच्या बँक खात्यातुन पोटोमॅक कंपनीच्या बँक खात्यामध्ये खालील प्रमाणे रक्कम ट्रान्सफर केली आहे.

16. \* Brief fact of the case (Add separate sheet, if necessary):  
प्रकरणाची थोडक्यात माहिती (आवश्यक असल्यास वेगळा कागद जोडावा)

Sr. No	Transaction Date	Amount	Value in INR
01	19/04/2017	72,932.15 AED	16,04,500/-
02	19/04/2017	72,983.04 AED	16,05,000/-
		Total	32,09,500/-

११) राजेश भगवानदास अग्रवाल यांच्या बँक खात्यामध्ये दिनांक २७/०२/२०१९ ते दिनांक ०४/०९/२०२० या कालावधीत एकूण 90,85,437/- इतकी रक्कम संगीता एव्हीएशन या कंपनीच्या बँक खात्यातून ट्रान्सफर करण्यात आली आहे.

१२) राजेश भगवानदास अग्रवाल यांच्या मालकीच्या बालाजी एंटरप्रायझेसच्या Bassein Catholic Co-Op Bank Ltd A/c No 012130300000051 या बँक खात्यामध्ये दिनांक २७/०२/२०१९ ते दिनांक ०४/०९/२०२० या कालावधीत एकूण 27,14,759/- इतकी रक्कम संगीता एव्हीएशन या कंपनीच्या बँक खात्यातून ट्रान्सफर करण्यात आली आहे.

वस्तुतः गेली अनेक वर्षे सुप्रिम ट्रान्सपोर्ट व संगीता एव्हीएशन या दोन्ही कंपन्या सातत्याने तोट्यात चालविण्यात येत आहेत. त्यामुळे फिर्यादी यांनी सन २०१२ सालापासून ते आजपावेतो कंपनीच्या खात्यामधून कोणताही आर्थिक मोबदला घेतलेला नाही. तसेच फिर्यादीचे वडील श्री कमल अग्रवाल, फिर्यादीचा सख्खा धाकटा भाऊ आकाश अग्रवाल यांनीही कोणताही आर्थिक मोबदला घेतलेला नाही. त्यामुळे वर नमुद केल्यानुसार आरोपी विमल अग्रवाल आणि इतरांच्या खात्यामध्ये एवढी प्रचंड रक्कम सन २०१८ ते २०२२ या कालावधीत टप्प्या टप्प्याने वळती करण्यामागे त्यांचा लबाडीचा उद्येश असल्याचे स्पष्ट दिसून येते. तसेच सदरची रक्कम वळती केल्याबाबत फिर्यादी यांना सदर कालावधीत कमलेश तातावत यांच्याकडूनही कोणताही पुर्वकल्पना प्राप्त झालेली नव्हती. त्यावरून विमल अग्रवाल आणि इतर लाभार्थी तसेच कमलेश तातावत यांच्यात आपसात संगणमत असल्याचेही स्पष्ट झाले.

फिर्यादी यांनी आरोपीशी संपर्क साधण्याचा वारंवार प्रयत्न केला परंतु त्यांनी कोणताही प्रतिसाद दिलेला नाही. उलटपक्षी दिनांक ११/११/२०२२ रोजी विमल अग्रवाल व गिरीष अग्रवाल यांनी एन.सी.एल.टी (नॅशनल कंपनी लॉ ट्रिब्युनल), मुंबई यांच्याकडे खटला दाखल करून सदर खटल्यामध्ये दिनांक ०१/०४/२०१९ पासून सुप्रिम ट्रान्सपोर्ट कंपनीने त्यांना कोणत्याही प्रकारचे मानधन दिले नाही असा दावा केला आहे.

अशा प्रकारे सुप्रिम ट्रान्सपोर्ट प्रा लि या कंपनीचे संचालक (१) विमल अग्रवाल व (२) गिरीष अग्रवाल आणि सी.एफ.ओ (३) कमलेश भैरव तातावत यांनी एप्रिल-२०१८ ते जुलै-२०२२ या कालावधीत आपसात संगणमत करून त्यांच्या वैयक्तिक आर्थिक फायद्या करीता भाडे आणि वेतनाच्या नावाखाली सुप्रिम ट्रान्सपोर्ट, संगीता एव्हीएशन या दोन कंपन्यांचे बँक खात्यातून तसेच फिर्यादी यांच्या वैयक्तिक बँक खात्यातून एकूण रुपये ६,२७,३६,१८०/- एवढी रक्कम (१) विमल अग्रवाल (२) नुपर अग्रवाल (३) गिरीष अग्रवाल (४) समीक्षा अग्रवाल (५) पिंकी अग्रवाल (६) स्वप्नील चव्हाण (७) स्नेहा चव्हाण (८) अतुल पांडे (९) रजनी पांडे,

(१०) राजेश भगवानदास अगरवाल यांच्या बँक खात्यामध्ये ट्रान्सफर करून एकुण ६,२७,३६,१८०/- एवढ्या रकमेचा अपहार करून फिर्यादी यांची फसवणुक केली असल्याचे स्पष्ट झाल्यानंतर फिर्यादी यांनी दिलेल्या तक्रारीवरून सदरचा गुन्हा नोंद करण्यात आला आहे.

**तपास:-** फिर्यादीने दिलेल्या तक्रारीवरून त्यांचा सविस्तर जबाब नोंद केला व सदरचा गुन्हा दाखल करण्यात आला.

गुन्ह्याच्या तपासात फिर्यादीने माहिती दिल्या प्रमाणे सुप्रीम ट्रान्सपोर्ट ऑर्गनायजेशन प्रा.ली. या कंपनीमध्ये सध्या एकुण पाच संचालक असून त्यापैकी आरोपी क्रमांक ०१ विमल अग्रवाल व आरोपी क्र. ०३ गिरीश अग्रवाल हे संचालक नमुद गुन्ह्यात आरोपी आहेत. गुन्ह्याच्या तपासात फिर्यादीने माहिती दिल्याप्रमाणे सुप्रीम ट्रान्सपोर्ट ऑर्गनायजेशन प्रा.ली. या कंपनीचे खालील बँकामध्ये खाती आहेत.

	Bank Name	Account Number
M/s Supreme Transport Origination Pvt. Limited	HDFC	10452840000014
	HDFC	03302840000157
	HDFC	01662840000470
	HDFC	03302840000140
	HDFC	04072840000053
	HDFC	00602340000085
	PNB	10451131002901
	BOI	843720110000498
	BOI	004420110000823

तसेच फिर्यादीची वैयक्तिक कंपनी संगीता एव्हीएशन प्रा.ली. हिचे देखील खालील बँकामध्ये खाती आहेत.

	Bank Name	Account Number
M/s Sangeeta Aviation Services Pvt. Ltd	Development Credit Bank (Customer ID 102173678)	00421300002745
	HDFC	50200008133578
	Citi Bank	0060246114
	Punjab National Bank	10454015001858

तसेच फिर्यादीच्या वैयक्तिक बँक खात्यांची माहिती खालील प्रमाणे.

	Bank Name	Account Number
Mr. Ammeet K. Agarwal	Development Credit Bank	00410200001403
	PNB	10452191004874

(G.C.P) K2297D

Form: 5-E

16. \* Brief fact of the case (Add separate sheet, if necessary):  
प्रकरणाची थोडक्यात माहिती (आवश्यक असल्यास वेगळा कागद जोडावा)

वर नमुद एकुण १५ बँक खात्यांचे संबंधीत बँकतुन सन २०१८ ते २०२२ या गुन्ह्याच्या कालावधीतील बँक स्टेटमेंट प्राप्त करण्यात आले.

तसेच नमुद गुन्ह्यातील आरोपी (१) विमल अगरवाल (२) नुपर अगरवाल (३) गिरीष अगरवाल (४) समीक्षा अगरवाल (५) पिंकी अगरवाल (६) स्वप्नील चव्हाण (७) स्नेहा चव्हाण (८) अतुल पांडे (९) रजनी पांडे, (१०) राजेश भगवानदास या सर्व आरोपींवर बँक खात्यांची माहिती खालील प्रमाणे.

Sr. No	Bank Name	A/C No.	A/C Name
01	HDFC	02721000019875	Vimal Agarwal
02	HDFC	02721000018984	Nupur Agarwal
03	HDFC	02721000019892	Girish Agarwal
04	HDFC	02721000070214	Samixa Agarwal
05	HDFC	02721000055437	Pinky Agarwal
06	HDFC	12111140000459	Atul Pandey
07	ICICI	104401531869	Swapnil Chavan
08	Saraswat	013200128873557	Sneha Chavan
09	PNB	1565000100131966,	Rajni Pandey
10	Axis	921010008877100	Swapnil Chavan

वर नमुद सर्व बँक खात्यांची सन २०१८ ते २०२२ या गुन्ह्याच्या कालावधीतील बँक स्टेटमेंट प्राप्त करण्यात आली.

फिर्यादीच्या वर नमुद दोन्ही कंपन्यांची बँक खाती व फिर्यादीचे वैयक्तिक बँक खाती यांची गुन्ह्यातील आरोपींच्या बँक खात्यांशी पडताळणी केली असता. गुन्ह्यातील आरोपींनी आरोपी क्र. ११ कमलेश भैरव तातावत या कंपनीच्या कार्यालयात अकाउंटंट या पदावर कार्यरत असणाऱ्या इसमासोबत संगनमत करून खोटे हिशोब तयार केले व एकत्रीत कट रचुन एकुण रू. ५,९५,६५,२८३/- एवढी रक्कम स्वतःच्या वर नमुद बँक खात्यांवर ट्रान्सफर करून नमुद रक्कमेचा अपहार केला हे तपासात निष्पन्न झाले आहे.

याबाबची सविस्तर विवरण पत्र (Fund flow Chart) तयार करून तो पुराव्याकामी गुन्ह्याच्या कागदोपत्री समाविष्ट करण्यात आला आहे.

आरोपी गिरीष भगवानदास अगरवाल याचे बाबत तपास केला असता तो "बि-१०३/१०४ फकरी कॉलनी, चंदुलाल पार्क, भाईदंर (प), ठाणे, महाराष्ट्र" या ठिकाणी असल्याची खात्रीलायक माहिती मिळाली होती. दिनांक १५/०६/२०२३ रोजी पोलीस उप-निरीक्षक संजय कल्हाटकर व पोलीस पथकाला नमुद पत्त्यावर पाठवुन आरोपी गिरीष अगरवाल याचा शोध घेतला असता तो मिळुन आल्याने त्याला सहार पोलीस ठाणे, मुंबई येथे आणुन त्याच्याकडे गुन्ह्याच्या अनुषंगाने तपास केला.

नमुद आरोपीचा गुन्ह्यातील सहभाग निष्पन्न झाल्याने त्यास नमुद गुन्ह्यात अटक करण्यात आलेले आहे.

➤ अटक आरोपी गिरीष जगदीशप्रसाद अगरवाल यांचे HDFC Bank A/c No 02721000019892 या खात्यामध्ये दिनांक २२/०६/२०१८ ते दिनांक ०६/०७/२०२२ या कालावधीत सुप्रिम ट्रान्सपोर्ट कंपनीच्या खात्यातून एकुण रक्कम रू. 13,45,036 संगीता एव्हीएशन कंपनीच्या खात्यातून एकुण रक्कम रू.

13,93,250 आणि अमित अगरवाल यांच्या खात्यातून रू. 8,00,000 अशी एकत्रित रू. 35,38,286/- इतकी रक्कम ट्रान्सफर करण्यात आली असल्याच्या प्रत्यक्ष नोंदी कंपनी व फियरिदी यांच्या बँक खात्यांच्या स्टेटमेंट व आरोपी गिरीष जगदीशप्रसाद अगरवाल यांच्या बँक खात्याच्या स्टेटमेंट यांची पडताळणी केली असता तपासात निष्पन्न झाले आहे. सदर रक्कम आरोपीकडून हस्तगत करणे बाकी आहे.

आरोपी गिरीष जगदीशप्रसाद अगरवाल यांच्या बँक खात्यामध्ये ट्रान्सफर करण्यात आलेल्या रकमेचा तपशील खालीलप्रमाणे :

A) सुप्रिम ट्रान्सपोर्ट कंपनीच्या बँक खात्यातून आरोपी गिरीष अगरवाल यांच्या बँक खात्यामध्ये ट्रान्सफर झालेल्या रकमेचा तपशील:-

From HDFC Bank A/c No 0330284000014 to Girish Agarwal Account			
Sr. No	Date	Transaction details (Narration)	Amount
01	14/08/2018	Director Rem	1,39,980
02	06/11/2018		1,50,000
03	13/02/2020		10,000
04	20/02/2021		35,000
		Total	3,34,980/-

From HDFC Bank A/c No 00602340000085 to Girish Agarwal Account			
Sr. No	Date	Transaction details (Narration)	Amount
01	03/08/2018		1,85,750.49
02	30/09/2019		301.53
03	18/01/2021		1577.38
04	06/09/2021		3.54
05	21/11/2021		86,979.98
06	10/04/2022		16,835.22
07	20/05/2022		72,608.34
		Total	3,24,056.48/-

From HDFC Bank A/c No 03302840000157 to Girish Agarwal Account			
Sr. No	Date	Transaction details (Narration)	Amount
01	21/07/2018		1,50,000
		Total	1,50,000/-

(G.C.P) K2297D

Form: 5-E

16. \* Brief fact of the case (Add separate sheet, if necessary):  
प्रकरणाची थोडक्यात माहिती (आवश्यक असल्यास वेगळा कागद जोडावा)

From HDFC Bank A/c No 04072840000053 to Girish Agarwal Account			
Sr. No	Date	Transaction details (Narration)	Amount
01	03/01/2020	Rent	2,40,000
Total			2,40,000/-

From PNB A/c No 10451131002901 to Girish Agarwal Account			
Sr. No	Date	Transaction details (Narration)	Amount
01	01/05/2022	NEFT	98,000
02	01/06/2022	NEFT	99,000
03	06/07/2022	NEFT	99,000
04		Total	2,96,000/-

- B) संगीता एव्हीएशन कंपनीच्या बँक खात्यातुन आरोपी गिरीष अगरवाल याच्या बँक खात्यामध्ये ट्रान्सफर झालेल्या रकमेचा तपशील:-

From PNB A/c (Sangeeta) to Girish Agarwal Account			
Sr. No	Date	Transaction details (Narration)	Amount
01	31/03/2021	RTGS	8,93,250
Total			8,93,250/-

From DCB A/c 00421300002745 to Girish Agarwal Account			
Sr. No	Date	Transaction details (Narration)	Amount
01	02/04/2021	NEFT	1,00,000
02	01/05/2021	NEFT	1,00,000
03	01/06/2021	NEFT	1,00,000
04	01/07/2021	NEFT	1,00,000
05	02/08/2021	NEFT	1,00,000
Total			5,00,000/-

- C) अमीत आग्रवाल यांच्या बँक खात्यातुन आरोपी गिरीष अगरवाल याच्या बँक खात्यामध्ये ट्रान्सफर झालेल्या रकमेचा तपशील:-

From DCB A/c 00410200001403 to Girish Agarwal Account			
Sr. No	Date	Transaction details (Narration)	Amount
01	01/01/2022	NEFT	1,00,000
02	01/02/2022	NEFT	1,00,000
03	02/03/2022	NEFT	1,00,000
Total			3,00,000/-

From PNB A/c 10452191004874 to Girish Agarwal Account			
Sr. No	Date	Transaction details (Narration)	Amount
01	04/09/2021	NEFT	1,00,000

02	01/10/2021	NEFT	1,00,000
03	01/11/2021	NEFT	1,00,000
04	01/12/2021	NEFT	1,00,000
05	02/04/2022	NEFT (Amit A/C entry 31/03/2022)	1,00,000
		Total	5,00,000/-

A	13,45,036
B	13,93,250
C	8,00,000
Total	35,38,286

अटक आरोपी गिरीश अग्रवाल याने अपहार केलेल्या वर नमुद रक्कमेच्या पुराव्याबाबत संबंधीत बँक खात्यांचे स्टेटमेंट गुन्ह्याच्या कागदपत्रांमध्ये समाविष्ट करण्यात आलेले आहे.

तसेच दिनांक १५/०६/२०२३ रोजी आरोपी स्वप्नील बबन चव्हाण याचा आम्ही स्वतः पोलीस पथकासह त्याच्या राहते घरी शोध घेतला असता तो त्याच्या राहते घरी मिळून आल्याने त्यालाही पोलीस ठाणेत आणून त्याच्याकडे गुन्ह्याच्या अनुषंगाने तपास केला. नमुद आरोपीचा गुन्ह्यातील सहभाग निष्पन्न झाल्याने त्यास सदर गुन्ह्यात अटक करण्यात आलेले आहे.

➤ अटक आरोपी स्वप्नील बबन चव्हाण यांचे यांचे ICICI Bank A/c No 104401531869 & Axis Bank A/c No 921010008877100 या खात्यामध्ये दिनांक १५/११/२०१९ ते दिनांक २७/१२/२०२१ या कालावधीत एकुण 45,52,400/- एवढी रक्कम संगीता एव्हीएशन कंपनीच्या बँक खात्यातून ट्रान्सफर झाली असल्याचे स्पष्ट झालेले आहे.

आरोपी स्वप्नील बबन चव्हाण याच्या बँक खात्यामध्ये ट्रान्सफर करण्यात आलेल्या रकमेचा तपशील खालीलप्रमाणे :

A) सुप्रिम ट्रान्सपोर्ट कंपनीच्या बँक खात्यातून आरोपी स्वप्नील चव्हाण याच्या बँक खात्यामध्ये ट्रान्सफर झालेल्या रकमेचा तपशील:-

Nil

B) संगीता एव्हीएशन कंपनीच्या बँक खात्यातून आरोपी स्वप्नील चव्हाण याच्या बँक खात्यामध्ये ट्रान्सफर झालेल्या रकमेचा तपशील:-

From DCB Bank A/c No 00421300002745 to Swapnil Chavan Account			
Sr. No	Date	Transaction details (Narration)	Amount
01	18/03/2021	RTGS	5,00,000
02	18/03/2021	RETGS	10,00,000
03	18/03/2021	NEFT	18,64,000
		Total	33,64,000/-

(G.C.P) K2297D

Form: 5-E

16. \* Brief fact of the case (Add separate sheet, if necessary):  
प्रकरणाची थोडक्यात माहिती (आवश्यक असल्यास वेगळा कागद जोडावा)

From City Bank A/c No 0060246114 to Swapnil Chavan Account			
Sr. No	Date	Transaction details (Narration)	Amount
01	15/11/2019	EFT	2,00,000
		Total	2,00,000/-

From HDFC Bank A/c No 50200008133578 to Swapnil Chavan Account			
Sr. No	Date	Transaction details (Narration)	Amount
01	07/09/2021	MC Issued	8,91,000
		Total	8,91,000/-

- C) अमीत आग्रवाल यांच्या बँक खात्यातून आरोपी स्वप्नील चव्हाण याच्या बँक खात्यामध्ये ट्रान्सफर झालेल्या रकमेचा तपशील:-

From DCB A/c No 00410200001403 to Swapnil Chavan Account			
Sr. No	Date	Transaction details (Narration)	Amount
01	24/12/2021	IMPS	50,000
02	25/12/2021	NEFT	47,400
		Total	97,400/-

A	Nil
B	44,55,000
C	97,400
Total	45,52,400

नमुद दोन्ही अटक आरोपींना विहित वेळेत रिमांडकामी मा. न्यायालयासमक्ष हजर केले असता मा. न्यायालयाने आरोपीतांस पोलीस कोठडी मंजूर केली.

- प्राप्त पोलीस कोठडीमध्ये अटक आरोपी गिरीश अग्रवाल याचेकडे केलेल्या तपासामध्ये खालील मुद्दे निष्पन्न झाले.

१) आरोपी गिरीश अग्रवाल याने तपासात सांगितले की, तो सुप्रिम ट्रान्सपोर्ट प्रा लि या कंपनीचा संचालक आहे. तसेच तो सदर कंपनीमध्ये कर्मचारी म्हणून काम देखील करित आहे. तसेच कंपनीच्या बँक खात्यातून त्याला मिळालेली रक्कम ही वेतन आणि कन्सलटन्सी चार्जेस म्हणून मिळालेली आहे.

२) सबब आरोपी गिरीष अगरवाल याला तो सुप्रिम ट्रान्सपोर्ट प्रा लि या कंपनीचा एम्प्लॉई असल्याबाबतची कागदपत्रे (नियुक्तीपत्र, तसेच कंपनीच्या संचालक मंडळाचे ठरावपत्र) हजर करण्यास सांगितले.

३) परंतु आरोपीने त्याबाबतची कोणतीही कागदपत्रे सादर करण्यास असमर्थता दर्शवली आहे.

४) तसेच आरोपी गिरीष अगरवाल याला मिळालेली रक्कम ही कन्सल्टन्सी चार्जेस म्हणुन देखील मिळाली होती असे त्याने सांगितले त्यावरून त्याने कंपनीला दिलेल्या सेवांच्या बदल्यातील बिले आणि कंपनीकडुन मिळालेल्या परचेस ऑर्डर सादर करण्यास सांगितले.

५) परंतु नमुद आरोपीने कन्सल्टन्सी चार्जेस तसेच परचेस ऑर्डर बाबतची कागदपत्रे हजर करण्यास असमर्थता दर्शवली.

६) यावरून आरोपी गिरीष अगरवाल याने उर्वरित आरोपीसोबत कट रचुन त्याच्या स्वतःच्या बँक खात्यामध्ये एकुण 35,38,286/- एवढी रक्कम ट्रान्सफर करुन घेऊन फिर्यादीची फसवणुक केली असल्याचे स्पष्ट होत आहे.

७) आरोपी गिरीष अगरवाला याच्याकडे त्याने फसवणुक केलेली रक्कम हस्तगत करण्याच्या अनुषंगाने त्याच्याकडे तपास केला असता सदरची रक्कम त्याने दैनंदिन वापरा करीता खर्च केली असल्याचे सांगुन फसवणुकीची रक्कम देण्यास असमर्थता दर्शवली आहे.

● प्राप्त पोलीस कोठडीमध्ये अटक आरोपी स्वप्नील चव्हाण याचेकडे केलेल्या तपासामध्ये खालील मुद्दे निष्पन्न झाले.

१) आरोपी स्वप्नील बबन चव्हाण याच्याकडे तपास केला असता त्याने अशी माहीती दिली आहे की, तो फिर्यादी यांच्या संगीता एव्हीएशन सर्व्हीसेस प्रा लि. या कंपनी करीता काम करीत होता.

२) संगीता एव्हीएशन कंपनीच्या बँक खात्यातुन त्याच्या बँक खात्यामध्ये ट्रान्सफर झालेली रक्कम ही संगीता एव्हीएशन कंपनीनेच, कंपनीच्या मुंबई बाहेरील प्रोजेक्टच्या कामासाठी त्याच्या बँक खात्यामध्ये पाठवली होती व त्याने सदरची रक्कम काडुन ती कंपनीच्या कामकाजासाठी खर्च केली आहे.

३) यावरून आरोपी स्वप्नील चव्हाण याला तो संगीता एव्हीएशन सर्व्हीसेस प्रा लि या कंपनीसोबत किंवा त्या कंपनी करीता काम करीत होता याबाबतची कागदपत्रे सादर करण्यास सांगितले.

४) परंतु त्याने तशी कोणतीही कागदपत्रे सादर करण्यास असमर्थता दर्शवलेली आहे.

५) आरोपीने तपासा दरम्यान दिनांक १७/०७/२०२३ रोजी खालील कागदपत्र सादर केली आहेत

(G.C.P) K2297D

Form: 5-E

16. \* Brief fact of the case (Add separate sheet, if necessary):

प्रकरणाची थोडक्यात माहिती (आवश्यक असल्यास वेगळा कागद जोडावा)

(1) Intimation Letter to Axis bank from M/s Sangeeta Aviation Services pvt.ltd.

(2) TDS Certificate 2017-18,

(3) TDS Certificate 2018-19

(4) TDS Certificate 2019-20

(5) TDS Certificate 2020-21

६) सदर कागदपत्राचे अवलोकन केले असता सदर कागदपत्रामध्ये दर्शविण्यात आलेली रक्कम ही सन २०१७, १८, १९, २० या कालावधीतील असल्याचे दिसून येत आहे.

७) तर आरोपी स्वप्नील चव्हाण याच्या बँक खात्यामध्ये जमा झालेली फसवणुकीची रक्कम सन-२०२१ या कालावधीतील आहे.

८) यावरून आरोपी हे पुर्वीची (जुनी) कागदपत्रे दाखवून त्याने फिर्यादीची फसवणुक केली नाही असे दर्शविण्याचा प्रयत्न करित असल्याचे स्पष्ट होत आहे.

९) अटक आरोपी स्वप्नील चव्हाण याने सांगितले की, एक्सीस बँकेला देण्यात आलेले इंटिमेशन लेटर हे संगीता एक्हीएशन कंपनीने अॅक्सीस बँकेस दिलेले आहे व त्यामध्ये त्याने सदर कंपनीकरीता केलेल्या कामाच्या बदल्यात कंपनीकडून त्याच्या एक्सीस बँकेतील खाते क्र. ९२१०१०००८८७१०० यावर खालील प्रमाणे रक्कम जमा करण्यात येत आहे.

Sr. No.	Perticulars	Amt (Rs.)
01	Consultancy Fees F.Y. 2017-18	7,00,000/-
02	Consultancy Fees F.Y. 2018-19	9,00,000/-
03	Consultancy Fees F.Y. 2019-20	9,00,000/-
04	Consultancy Fees F.Y. 2020-21	9,00,000/-
	Total	34,00,000/-
	Less-TDS	36,000/-
	Total Paid	33,64,000/-

१०) या पत्राबाबत फिर्यादीस विचारणा केली असता फिर्यादीने संगीता एक्हीएशन कंपनी मार्फतीने असे कोणतेही पत्र आरोपी स्वप्नील चव्हाण यास दिलेले नसल्याचे सांगितले.

११) तसेच सदर पत्राच्या अखेरीस असलेली सही ही देखील फिर्यादीची नसून ती खोटी असल्याचे सांगितले आहे. तसेच संगीता एक्हीएशन या कंपनीचा ऑथोराइज सिग्नेटरी हे फिर्यादी स्वतः असल्याने त्यांच्या सही शिवाय वरील पेमेंट देणे अशक्य असल्याची माहिती फिर्यादीने सांगितली.

१२) आरोपी स्वप्नील चव्हाण याने सादर केलेल्या पत्रातील सही व फिर्यादीची नैसर्गिक सही चे बारकाईने अवलोकण केले असता यात कोणतेही साम्य दिसून आले नाही.

१३) तसेच आरोपी स्वप्नील चव्हाण याचे अॅक्सीस बँकेतील खात्यावर वरीलप्रमाणे रक्कम डिपॉजीज करण्याकरीता बँकेला कंपनीकडून पत्र देण्याची आवश्यकता का असावी? याबाबत कोणतेही सकारात्मक स्पष्टीकरण आरोपीने दिलेले नाही.

१४) याबाबत अधिक तपास करण्याकरीता जा.क्र. ३५८२/२०२३ दि. २२/०६/२३ अन्वये संबंधीत एक्सीस बँकेस पत्र देवुन नमुद इंटीमेशन लेटर बाबत माहिती घेण्यात आली असता एक्सीस बँकेने असे कोणतेही पत्र त्यांच्या अभिलेखावर त्यांना मिळुन आलेले नसल्याचा अभिप्राय दिला आहे. तसेच पैसे खात्यावर डिपॉजीट करण्याकरीता बँकेकडून कोणत्याही पत्राची किंवा स्पष्टीकरणाची बँक मागणी करत नसल्याची माहिती दिली आहे. एक्सीस बँकेकडून प्राप्त झालेल्या पत्राची मुळ प्रत पुरावा म्हणुन गुन्ह्याच्या कगदपत्रांमध्ये समाविष्ट करण्यात आलेली आहे.

१५) आरोपी स्वप्नील चव्हाण याने तपासात सादर केलेले सन २०१७ ते २१ या कालावधीतील टीडीएस प्रमाणपत्रांची सत्यता पडताळणीकरीता आयकर विभाग मुंबई यांचे कार्यालयास पत्रव्यवहार करण्यात आला असुन अद्यापपर्यंत संबंधीत कार्यालयातुन माहिती प्राप्त झालेली नाही.

१६) आरोपी स्वप्नील चव्हाण याने वित्तीय वर्ष २०१७ ते २०२१ या कालावधीतील टीडीएस प्रमाणपत्र जरी तपासात सादर केले असले तरी नमुद आरोपीच्या बँक खात्यात फसवणुकीची रक्कम सन २०२१ या एकाच वर्षात जमा झाली असुन वेगवेगळ्या तारखेस जमा झालेल्या रक्कमेचे वर्णन व टीडीएस प्रमाणपत्रातील रक्कमेचे वर्णन यात साम्य आढळुन येत नाही. यावरून आरोपी तपासाची दिशाभुल करीत असल्याचे निष्पन्न होत आहे.

१७) अटक आरोपी स्वप्नील चव्हाण याने तपासात सहकार्य न केल्याने त्याच्या खात्यावर जमा झालेली फसवणुकीची रक्कम हस्तगत करणे बाकी आहे.

नमुद गुन्ह्यातील अटक आरोपींकडून प्राप्त झालेल्या माहितीवरून तसेच गुन्ह्याच्या एकंदरीत तपासात गुन्ह्यातील आरोपींनी केलेल्या पैशांच्या अपहाराची आरोपीनिहाय खालीलप्रमाणे समरी सादर करीत आहे.

**अपहारीत रकमेचा तपशील:-**

अ. क्र	आरोपीचे नाव	सुप्रीम ट्रान्सपोर्ट (A)	संगीता एव्हीएशन (B)	अमीत अगरवाल (C)	एकुण
०१	विमल अगरवाल	२,०१,४२,१४८	५,००,०००	४,००,०००	२,१०,४२,१४८/-
०२	नुपुर अगरवाल	१८,९१,४५६	८,१७,६००	८,००,०००	३५,०९,०५६/-
०३	गिरीष अगरवाल	१३,४५,०३६	१३,९३,२५०	८,००,०००	३५,३८,२८६/-
०४	समीक्षा अकरवाल	८,७९,९७०	१०,९५,५००	८,००,०००	२७,७५,४७०/-

०५	पिंकी अगरवाल	११,३४,९७०	८,७७,१५०	७,८६,६११	२७,९८,७३१/-
०६	स्वप्नील चव्हाण	—	४४,५५,०००	९७,४००	४५,५२,४००/-
०७	स्नेहा चव्हाण	—	४७,५५,०००	—	४७,५५,०००/-
०८	अतुल पांडे	—	३५,६४,०००	१,७०,०००	३७,३४,०००/-
०९	रजनी पांडे	—	११,००,०००	—	११,००,०००/-
१०	राजेश अगरवाल	—	९०,८५,४२८	—	९०,८५,४२८/-
११	बालाजी एटरप्रायझेस	—	२७,१४,७५९	—	२७,१४,७५९/-
				एकुण	५,९५,६५,२८३/-

अटक आरोपी व पाहीजे आरोपींच्या बँक खात्यामध्ये ट्रान्सफर झालेल्या रकमे बाबत फिर्यादी यांच्या कंपनीच्या अभिलेखावर कोणत्याही प्रकारची नोंद नाही. तसेच अटक आरोपी व पाहीजे आरोपींना रक्कम देण्याबाबत कोणत्याही प्रकारचा संचालक मंडळाचा ठराव मंजूर झाला नसल्याचे स्पष्ट झालेले आहे. यावरून अटक आरोपी व पाहीजे आरोपींच्या बँक खात्यामध्ये ट्रान्सफर झालेली रक्कम ही गुन्ह्यातील अपहाराचीच रक्कम असल्याचे स्पष्ट झालेले आहे.

गुन्ह्याच्या तपासातील निष्पन्न झालेले काही ठळक मुद्दे —

- अटक आरोपी व पाहीजे आरोपींचे आपसात खालील प्रमाणे नातेसंबंध आहेत.
  - पाहीजे आरोपी विमल अगरवाल व गिरीष अगरवाल हे फिर्यादीचे चुलत भाऊ आहेत.
  - पाहीजे आरोपी नूपुर अगरवाल ही विमल अगरवाल यांची पत्नी आहे.
  - पाहीजे आरोपी समिक्षा अगरवाल ही गिरीष अगरवाल यांची पत्नी आहे.
  - पाहीजे आरोपी पिंकी अगरवाल ही फिर्यादी यांची चुलत बहीण असून विमल व गिरीष अगरवाल यांची सख्खी बहीण आहे.
  - पाहीजे आरोपी कमलेश भैरव तातावत हा फिर्यादीच्या कंपनीतील कर्मचारी आहे.
  - पाहीजे आरोपी अतुल पांडे व स्वप्नील चव्हाण हे फिर्यादीचे मित्र आहेत.
  - पाहीजे आरोपी रजनी पांडे ही अतुल पांडे यांची आई तर पाहीजे आरोपी स्नेहा चव्हाण ही स्वप्नील चव्हाण यांची आई आहे.
  - अर्जदार आरोपी हा आरोपी विमल व गिरीष अगरवाल यांचा मेव्हणा आहे.
- गुन्ह्यातील आरोपी श्रीमती नूपुर अगरवाल, समिक्षा अगरवाल, पिंकी अगरवाल या फिर्यादीची कंपनी सुप्रीम ट्रान्सपोर्ट ऑर्गनायझेशन प्रा लि व संगीता एव्हीएशन सर्वीसेस प्रा लि या दोन्ही कंपन्यामध्ये कोणतेही पद भुषवीत नसतानाही त्यांना कंपनीच्या विविध खात्यातून प्रती महीना (प्रत्येक महीन्याला) ४ ते ५ वेळा वेतन आणि भाड्याच्या नावाखाली पैसे मिळाले असल्याचे निष्पन्न झालेले आहे. यावरून आरोपींनी पुर्व नियोजित कट रचून सदर गुन्हा केला असल्याचे स्पष्ट झालेले आहे.
- अटक आरोपी स्वप्नील चव्हाण व पाहीजे आरोपी स्नेहा चव्हाण, रजनी पांडे, व अतुल पांडे हे देखील फिर्यादीच्या दोन्ही कंपनीमध्ये कोणतेही पद भुषवीत नसतानाही, तसेच त्यांनी कंपनीला कोणत्याही प्रकारची सेवा दिलेली नसतानाही

त्यांच्याही बँक खात्यामध्ये रक्कम ट्रान्सफर झाली असल्याचे निष्पन्न झालेले आहे. आरोपी श्रीमती नुपुर अगरवाल, समीक्षा अगरवाल, पिकी अगरवाल, स्वप्नील चव्हाण स्नेहा चव्हाण, रजनी पांडे, व अतुल पांडे यांच्या बँक खात्यावर जमा झालेल्या रक्कमेबाबत कंपनीच्या अभिलेखावर कोणत्याही प्रकारची नोंद नाही, तसेच त्यांना रक्कम देण्या बाबत कंपनीच्या संचालक मंडळामध्ये कोणत्याही प्रकारचा ठराव मंजूर झालेला नाही. अद्यापपर्यंतच्या तपासात यापैकी कोणीही संचालक मंडळाच्या ठरावाचे कोणतेही कागदपत्रे सादर केलेली नाहीत.

- फिर्दादीची कंपनी सुप्रिम ट्रान्सपोर्ट व संगिता एव्हिएशन यांच्या बँक खात्यापैकी HDFC बँकेच्या खात्याचा अॅक्सेस पाहीजे आरोपी विमल अगरवाल व अटक आरोपी गिरीष अगरवाल यांच्याकडे होता. तर उर्वरित बँक खात्यांचा अॅक्सेस कंपनीचे सी.एफ.ओ. (चिफ अकाउंट ऑफिसर) पाहीजे आरोपी कमलेश तातावत यांच्याकडे होता. आरोपी विमल अगरवाल व गिरीष अगरवाल यांनी कंपनीचे सी. एफ.ओ. आरोपी कमलेश तातावत व इतर आरोपीसोबत संगणमत करून तसेच पुर्वनियोजित कट रचून सदर रकमेचा अपहार केला असल्याचे निष्पन्न झाले आहे.
- आरोपींनी फिर्दादी यांच्या कंपनीच्या बँक खात्यातून तसेच फिर्दादीच्या वैयक्तिक बँक खात्यातील एकूण 5,95,65,283/- एवढ्या रकमेचा अपहार केला असल्याचे स्पष्ट झाल्यानंतर आरोपींची कलम १०२ फौदप्रस अन्वये बँक खाती गोठविण्यात आली असून आरोपींच्या बँक खात्याचा तपशील खालील प्रमाणे आहे. आरोपींची नमुद बँक खाती गोठविण्यात आल्या बाबतची माहीती मा. महानगर दंडाधिकारी, ६५ वे न्यायालय, अंधेरी, मुंबई यांचे न्यायालयात सादर करण्यात आली आहे.

आरोपींच्या गोठविण्यात आलेल्या बँक खात्याचा तपशील:-

Sr. No	Bank Name	Account Numbers	Account holder Names
01	HDFC	02721000019875	Vimal Agarwal
02	HDFC	02721000018984	Nupur Agarwal
03	HDFC	02721000019892	Girish Agarwal
04	HDFC	02721000070214	Samixa Agarwal
05	HDFC	02721000055437	Pinky Agarwal
06	ICICI	104401531869	Swapnil Chavan
07	Axis	921010008877100	Swapnil Baban Chavan
08	Saraswat	013200128873557	Sneha Baban Chavan
09	HDFC	12111140000459	Atul Pandey
10	PNB	1565000100131966,	Rajni Surendra Pandey
11	ICICI	623501540474	Rajesh Agarwal

- अटक आरोपी व पाहीजे आरोपी यांनी फिर्दादी यांच्या वैयक्तिक बँक खात्यातून तसेच फिर्दादी यांच्या दोन्ही कंपनीच्या बँक खात्यातून ट्रान्सफर

16. \* Brief fact of the case (Add separate sheet, if necessary):  
प्रकरणाची थोडक्यात माहिती (आवश्यक असल्यास वेगळा कागद जोडावा)

झालेली संपुर्ण रक्कम काढून घेतली असल्यामुळे सदरची रक्कम हस्तगत करणे शक्य झालेले नाही.

- फिर्यादी यांच्या वैयक्तिक बँक खात्यातून तसेच त्यांच्या दोन्ही कंपनीच्या कंपन्यांच्या बँक खात्यातून गुन्ह्यातील आरोपींच्या बँक खात्यामध्ये ट्रान्सफर झालेली रक्कम ही नमुद गुन्ह्याच्या घोटाळयातील रक्कम असल्याबाबत कंपनीचे सी.ए. श्री गिरीष मुंदडा यांनी फिर्यादी यांना दिनांक ०२/०३/२०२३ रोजी ऑडिट रिपोर्ट सादर केला असून सदर अहवालाची एक प्रत सहार पोलीस ठाणेला देखील त्यांनी दिली आहे.
- सदर गुन्ह्यातील पाहीजे आरोपी (१) विमलकुमार जगदीशप्रसाद आग्रवाल (२) नुपर विमलकुमार अग्रवाल (३) समीक्षा गिरीष अग्रवाल (४) पिकी जगदीशप्रसाद अग्रवाल (५) स्नेहा बबन चव्हाण (६) राजेश भगवानदास अग्रवाल यांचा अटक पुर्व जामीन अर्ज मा. सत्र न्यायालय, दिंडोशी, मुंबई यांनी नामंजुर केला असून त्याविरोधात त्यांनी मा. उच्च न्यायालयात याचिका दाखल केली असून या सर्वांच्या याचिकेवर सुनावणी प्रलंबीत आहे.
- पाहीजे आरोपी (१) विमलकुमार जगदीशप्रसाद आग्रवाल (२) नुपर विमलकुमार अग्रवाल (३) समीक्षा गिरीष अग्रवाल (४) पिकी जगदीशप्रसाद अग्रवाल (५) स्नेहा बबन चव्हाण (६) अतुल सुरेद्र पांडे (७) रजनी सुरेद्र पांडे, (८) राजेश भगवानदास अग्रवाल (९) कमलेश भैरवा तातावत यांचा शोध सुरू असून ते मिळून येताच त्यांना नुमद गुन्ह्यात अटक करण्याची तजवीज ठेवली आहे.
- तसेच यापैकी ज्यांचे मा. उच्च न्यायालयात सुरू असलेल्या अटकपुर्व जामिन अर्जांच्या सुनावणीत मा. न्यायालयाकडून प्राप्त अंतिम आदेशाप्रमाणे योग्य ती कार्यवाही करण्याची तजवीज ठेवण्यात आली आहे.
- गुन्ह्यातील पाहीजे आरोपींची खालीलप्रमाणे पाहीजे आरोपी नोंदवही मध्ये नोंद घेवून अभिलेखावर ठेवण्यात आले आहे.

अ.क्र.	पाहीजे आरोपीचे नाव	पाहीजे आरोपी नोंदवही क्रमांक
१	विमलकुमार जगदीशप्रसाद अग्रवाल	४५१
२	नुपर विमलकुमार अग्रवाल	४५२
३	समीक्षा गिरीष अग्रवाल	४५३
४	पिकी जगदीशप्रसाद अग्रवाल	४५४
५	स्नेहा बबन चव्हाण	४५५
६	अतुल सुरेद्र पांडे	४५६
७	रजनी सुरेद्र पांडे	४५७

८	राजेश भगवानदास अग्रवाल	४५८
९	कमलेश भैरवा तातावत	४५९

- गुन्हयातील अटक आरोपी १) गिरीषकुमार जगदीशप्रसाद अग्रवाल व २) स्वप्नील बबन चव्हाण यांचेविरुद्ध दोषारोपपत्र मा. न्यायालयात सादर करण्याचा कालावधी संपुष्टात येत असल्याने त्यांच्याविरुद्ध दोषारोपपत्र तयार करून ते विहित वेळेत मा. न्यायालयात सादर करण्यात येत आहे. तसेच प्रस्तुत गुन्हयातील उर्वरित आरोपींविरुद्ध तपास सुरू असून ते मिळून येताच त्यांच्या विरुद्ध पुरवणी दोषारोपपत्र मा. न्यायालयात सादर करण्याची तजवीज ठेवण्यात आली आहे.
- तसेच नमुद गुन्हयाचा तपास चालू ठेवण्यात आला असून पुढील तपासामध्ये अटक आरोपींविरुद्ध आणखीन काही पुरावे उपलब्ध झाल्यास ते फौ.दं.प्र.सं. कलम १७३(८) अन्वये गुन्हयातील उर्वरित पाहीजे आरोपींच्या पुरवणी दोषारोपपत्रासह न्यायालयात सादर करण्याची तजविज ठेवली आहे.

अटक आरोपी (१) जगदीशप्रसाद अग्रवाल व (२) स्वप्नील बबन चव्हाण यांचे विरुद्ध दोषारोपपत्र सादर करणे इतपत पुरेसा सबळ पुरावा उपलब्ध झाला आहे. सबब नमुद दोन्ही आरोपींविरुद्ध विहित नमुन्यात दोषारोपपत्र तयार करून ते सोबत जोडण्यात आले आहे. सदर दोषारोपपत्र मा. महानगर दंडाधिकारी, ६३ वे न्यायालय, अंधेरी, मुंबई यांचे न्यायालयात सादर करित आहोत.

### “दोषारोप”

मा. महानगर दंडाधिकारी, ६३ वे न्यायालय, अंधेरी, मुंबई यांच्या स्थळसिमेत, सहार पोलीस ठाणे हद्दीतील “ सुप्रिम ट्रान्सपोर्ट प्रा लि आणि संगीता एव्हीएशन सर्विस प्रा लि, पत्ता— ५/बी—३४, ५/बी—३२ अक्षय मित्तल इंडस्ट्रीयल इस्टेट, अंधेरी कुर्ला रोड, अंधेरी (पुर्व), मुंबई ” येथे एप्रिल—२०१८ ते जुलै—२०२२ या कालावधीत सदर गुन्हा घडला आहे.

अटक आरोपी (१) गिरीष जगदीशप्रसाद अग्रवाल, वय ४० वर्षे (२) स्वप्नील बबन चव्हाण, वय ३४ वर्षे यांनी तसेच पाहीजे आरोपी (१) विमल अग्रवाल (२) नुपर अग्रवाल (३) गिरीष अग्रवाल (४) समीक्षा अग्रवाल (५) पिकी अग्रवाल (६) स्वप्नील चव्हाण (७) स्नेहा चव्हाण (८) अतुल पांडे (९) रजनी पांडे, (१०) राजेश भगवानदास अग्रवाल यांनी पाहीजे आरोपी (११) कमलेश भैरव तातावत यांच्याशी संगणमत करून पुर्वनियोजित कट रचून त्यांच्या मदतीने एप्रिल—२०१८ ते जुलै—२०२२ या कालावधीत फिर्यादी यांच्या सुप्रिम ट्रान्सपोर्ट प्रा लि आणि संगीता एव्हीएशन सर्विस प्रा लि या कंपनीच्या बँक खात्यातून व फिर्यादी यांच्या वैयक्तीक बँक खात्यातून एकूण 5,95,65,283/- एवढी रक्कम स्वतःच्या बँक खात्यामध्ये ट्रान्सफर करून घेतली आहे. तसेच सदर रक्कम ट्रान्सफर केल्याची माहीती मिळू नये करिता आरोपींनी संगणमताने खोटे हिशोब तयार केले. अशा प्रकारे अटक आरोपी व पाहीजे

(G.C.P) K2297D

Form: 5-E

16. \* Brief fact of the case (Add separate sheet, if necessary):  
प्रकरणाची थोडक्यात माहिती (आवश्यक असल्यास वेगळा कागद जोडावा)

आरोपींनी अपहार करून फिर्यादी यांची एकूण 5,95,65,283/- एवढ्या रकमेची फसवणुक केली आहे, म्हणून आरोपी गिरीष जगदीशप्रसाद अगरवाल व स्वप्नील बबन चव्हाण यांचे विरुद्ध कलम १२०(ब), ४०८, ४०९, ४७७(अ), ४२०, ३४ भादवि, अन्वये दोषारोप आहे.

17. Refer Notice Served.....Yes/No.....Dated  
संदर्भ नोटीस बजावली होय/नाही तारीख  
(Acknowledgement to be placed)  
(पोचपावती सादर करावी)

18. Dispatched on.....  
पाठविण्याची तारीख

Forwarded by Station House  
Officer/Officer-in-charge  
ठाणे अमलदार/प्रभारी अधिका—याने अग्रेषित केले

Signature of the Investigation officer  
submitting the Final Report/Charge sheet  
अंतिम अहवाल/आरोपपत्र सादर करणा—या  
अधिका—याची सही

Name: संजय सोविकर  
Rank: वरिष्ठ पोलीस निरीक्षक  
PS: सहार पोलीस ठाणे, मुंबई

Name: संदीप शिंदे  
Rank: सहाय्यक पो. निरीक्षक  
PS: सहार पोलीस ठाणे, मुंबई

**FIRST INFORMATION REPORT**

(Under Section 154 Cr.P.C.)

प्रथम खबर अहवाल  
(कलम १५४ फौजदारी प्रक्रिया संहिता)

गुल्फ - 155/23

1. District (जिल्हा): बृहन्मुंबई शहर

P.S.(ठाणे): सहार

Year (वर्ष): 2023

FIR No.(प्रथम खबर क्र.): 0207

Date and Time of FIR (प्र. ख. दिनांक आणि वेळ): 25/04/2023 16:56 बजे

S.No. (अ.क्र.)	Acts (अधिनियम)	Sections (कलम)
1	भारतीय दंड संहिता १८६०	120-B
2	भारतीय दंड संहिता १८६०	४०८
3	भारतीय दंड संहिता १८६०	४०९
4	भारतीय दंड संहिता १८६०	477-A
5	भारतीय दंड संहिता १८६०	४२०
6	भारतीय दंड संहिता १८६०	३४

3. (a) Occurrence of offence (गुन्ह्याची घटना):

1. Day(दिवस): दरमियानी दिन

Date From (दिनांक पासून): 01/04/2018

Time Period

Date To (दिनांक पर्यंत): 31/07/2022

(कालावधी):

Time From (वेळेपासून): 00:00 बजे

Time To (वेळेपर्यंत): 00:00 बजे

(b) Information received at P.S. (माहिती मिळालेले पोलीस ठाणे):

Date (दिनांक ): 25/04/2023

Time (वेळ): 16:56 बजे

(c) General Diary Reference (रोजनामचा संदर्भ)

Entry No. (नोंद क्र.): 033

Date &amp; Time (दिनांक आणि वेळ): 25/04/2023 16:56 बजे

4. Type of Information (माहितीचा प्रकार): Oral

5. Place of Occurrence (घटनास्थळ):

1.(a) Direction and distance from P.S.(पोलीस ठाण्यापासून दिशा व अंतर): पूर्व, 5 किमी

Beat No. (बिट क्र.):

(b) Address (पत्ता): कंपनीचे आसिफ 5/बी-34, 5/बी-32, अक्षय मित्तल इंडस्ट्रीयल इस्ट, अंधेरी कुर्ला रोड, अंधेरी पुर

(c) In case, outside the limit of this Police Station, then (या पोलीस ठाण्याच्या हद्दीबाहेर असल्यास):

Name of P.S.(पोलीस ठाण्याचे नाव):

District(State) (जिल्हा(राज्य)):

स.पो.आयुक्त व.पो.नि.पो.नि.गुल्फ  
 26 APR 2023 26 APR 2023 26 APR 2023

## 6. Complainant / Informant (तक्रारदार/माहिती देणारा):

(a) Name (नाव): अमीत कमल अगरवाल

(b) Father's/Husband's Name (वडील / पती चे नाव):

(c) Date/Year of Birth (जन्म तारीख/वर्ष): 1989

(d) Nationality (राष्ट्रीयत्व): भारत

(e) UID No. (यु.आय.डी. क्र.):

(f) Passport No. (पारपत्र क्र.):

Date of Issue (दिल्याची तारीख):

Place of Issue (दिल्याचे ठिकाण):

(g) Id details (Ration Card, Voter ID Card, Passport, UID No., Driving License, PAN)

ओळखपत्र विवरण (राशन कार्ड, मतदाता कार्ड, पासपोर्ट, यूआईडी सं., ड्राइविंग लाइसेंस, पॅन कार्ड)

S.No. (अ. क्र.)	Id Type (ओळखपत्राचा प्रकार)	Id Number (ओळखपत्राचा क्रमांक)
1		

(h) Address (पत्ता):

S.No. (अ. क्र.)	Address Type (पत्त्याचा प्रकार)	Address (पत्ता)
1	वर्तमान पत्ता	901 बिकानेर भवन, जे बी नगर, अंधेरी पूर्व, मुंबई, सहार, बृहनमुंबई शहर, महाराष्ट्र, भारत
2	स्थायी पत्ता	901 बिकानेर भवन, जे बी नगर, अंधेरी पूर्व, मुंबई, सहार, बृहनमुंबई शहर, महाराष्ट्र, भारत

(i) Occupation (व्यवसाय):

(j) Phone number (फोन नं.):

Mobile (मोबाइल नं.):

## 7. Details of known/suspected/unknown accused with full particulars (माहित असलेल्या / संशयीत/अनोळखी आरोपीचा संपूर्ण पत्ता):

S.No. (अ.क्र.)	Name (नाव)	Alias (उर्फनाव)	Relative's Name (नातेवाईकाचे नाव)	Present Address (वर्तमान पत्ता)
1	विमल अगरवाल			1. बेगलोर, सहार, बृहनमुंबई शहर, महाराष्ट्र, भारत
2	गिरीश अगरवाल			1. माहिती नाही, सहार, बृहनमुंबई शहर, महाराष्ट्र, भारत
3	कमलेश भैरव-तातावत			1. माहिती नाही, सहार, बृहनमुंबई शहर, महाराष्ट्र, भारत
4	नुपर अगरवाल			1. माहिती नाही, सहार, बृहनमुंबई शहर, महाराष्ट्र, भारत
5	समीक्षा अगरवाल			1. माहिती नाही, सहार, बृहनमुंबई शहर, महाराष्ट्र, भारत
6	पिकी अगरवाल			1. माहिती नाही, सहार, बृहनमुंबई शहर, महाराष्ट्र, भारत
7	स्वप्नील चव्हाण			1. माहिती नाही, सहार, बृहनमुंबई शहर, महाराष्ट्र, भारत
8	स्नेहा चव्हाण			1. माहिती नाही, सहार, बृहनमुंबई शहर, महाराष्ट्र, भारत
9	अतुल पांडे			1. माहिती नाही, सहार, बृहनमुंबई शहर, महाराष्ट्र, भारत

Sandeep

2

Anant Agarwal

## I.I.F.-I (एकीकृत अन्वेषण फॉर्म - १)

10	रजनी पांडे		1. माहिती नाही ,सहार,बृहनमुंबई शहर, महाराष्ट्र, भारत
11	राजेश भगवानदास अगरवाल		1. माहिती नाही ,सहार,बृहनमुंबई शहर, महाराष्ट्र, भारत

8. Reasons for delay in reporting by the complainant/informant (तक्रारदार/माहिती देणा-याकडून तक्रार करण्यातील विलंबाची कारणे):

9. Particulars of properties of interest (संबंधीत मालमत्तेचा तपशील):

S.No. (अ.क्र.)	Property Category (मालमत्ता वर्ग)	Property Type (मालमत्ता प्रकार)	Description (वर्णन)	Value(In Rs/-) (मुल्य (रु. मध्ये))
----------------	-----------------------------------	---------------------------------	---------------------	------------------------------------

10 Total value of property (In Rs/-)-(चोरीस गेलेल्या मालमत्तेचे एकूण मुल्य (रु. मध्ये)):

11 Inquest Report / U.D. case No., if any (इन्क्वेस्ट अहवाल/ अकस्मात मृत्यू प्रकरण क्र.,जर असल्यास):

S.No. (अ.क्र.)	UIDB Number (यु.आय.डी. बी.क्र.)
----------------	---------------------------------

12 First Information contents (प्रथम खबर हकीकत ):

फिर्यादीचा सविस्तर जबाब सोबत जोडलेला आहे. गुरक्रं 155/23

श्री. अमीत कमल अगरवाल, वय 34 वर्षे, धंदा-व्यवसाय, रा.ठी. 901 बिकानेर भवन, जे.बी. नगर, अंधेरी (पुर्व), मुंबई (मोबा-9870811224)

मी, वरील प्रमाणे असून वर नमुद पत्त्यावर माझे वडील श्री. कमल अगरवाल व आई श्रीमती संगीता अगरवाल यांच्या सोबत रहावयास आहे. माझे वडील श्री. कमल अगरवाल यांनी सन-2008 मध्ये सुप्रिम ट्रान्सपोर्ट प्रा लि या नावाची कंपनी सुरु केलेली आहे. मी संगीता एव्हीएशन सर्विस प्रा लि या कंपनीची स्थापना सन-2012 मध्ये केलेली आहे. या दोन्ही कंपन्यामध्ये मी अध्यक्ष आणि कार्यकारी संचालक म्हणून सध्या कार्यरत आहे. दोन्ही कंपनीचे ऑफिस 5/बी-34, 5/बी-32 अक्षय मितल इंडस्ट्रीयल इस्टेट, अंधेरी कुर्ला रोड, अंधेरी (पुर्व), मुंबई या ठिकाणी आहे.

कंपनीचे संचालक (1) श्री. विमल अगरवाल व (2) गिरीश अगरवाल आणि कंपनीचे सी.एफ.ओ (3) कमलेश भैरव-तातावत यांनी आपसात संगणमत करून एप्रिल-2018 ते जुलै-2022 या कालावधीत भाडे आणि वेतनाच्या नावाखाली कंपनीच्या एकुण 5 कोटी रुपयांचा अपहार केला असल्याबाबत मी डिसेंबर-2022 मध्ये मा. पोलीस सह आयुक्त, आर्थिक गुन्हे शाखा, मुंबई यांच्याकडे तक्रार केली होती, परंतु त्यांनी माझी तक्रार स्थानीक पोलीस ठाण्याकडे पाठवली असल्याचे कळविलेले आहे. सबब मी दिनांक 07/01/2023 रोजी सहार पोलीस ठाणे येथे लेखी तक्रार केली असून त्या अनुषंगाने मी खालील प्रमाणे सविस्तर जबाब देत आहे.

सुप्रिम ट्रान्सपोर्ट प्रा लि या कंपनीमध्ये मी स्वतः, तसेच माझे वडील श्री. कमल अगरवाल, माझा सख्खा धाकटा भाऊ श्री. आकाश अगरवाल आणि श्री. विमल अगरवाल व श्री. गिरीश अगरवाल असे एकुण 05 संचालक आहेत. सदर कंपनीचा मुख्य व्यवसाय मालाची रस्ते वाहतूक आणि हवाई वाहतूक करण्याचा आहे. कंपनीच्या मालकीची काही वाहने व विमान आहे. या व्यतीरीक कंपनीच्या व्यवसाया करीता आवश्यकते नुसार भाडे तत्वावर वाहने घेतली जातात. सदर कंपनीचे मुख्य कार्यालय मुंबईमध्ये असून पनवेल, कळंबोली, राजस्थान, गुजरात, दिल्ली आणि बंगलोर या ठिकाणी शाखा व विभागीय कार्यालये आहेत.

संचालकापैकी श्री. विमल अगरवाल हे बंगलोर येथे रहावयास आहेत. श्री. गिरीश अगरवाल हे दिल्ली येथे रहावयास आहेत. ते दोघेही नात्याने माझे चुलतभाऊ आहेत. त्यांचे दिवंगत वडील कै. जगदीशप्रसाद अगरवाल माझ्या वडीलांचे सख्खे मोठे भाऊ होते. कै. जगदीशप्रसाद अगरवाल यांच्या मृत्यु नंतर श्री. विमल अगरवाल आणि श्री गिरीश अगरवाल यांची परस्परातील सहमती नुसार सुप्रिम ट्रान्सपोर्ट कंपनीमध्ये संचालक म्हणून नियुक्ती करण्यात आली आहे. ते दोघेही प्रत्येक महिन्यातील काही दिवस मुंबईमध्ये राहून कंपनीच्या दैनंदिन कामकाजात सहभागी होत असत.

सुप्रिम ट्रान्सपोर्ट प्रा लि. ही कंपनी तोटयात व्यवसाय करीत असल्यामुळे सन-2012 साली आमच्या कुटुंबातील आपसातील समझौत्या नुसार माझी सदर कंपनीमध्ये कार्यकारी संचालक आणि अध्यक्ष म्हणून नेमणूक करण्यात आली आहे. तेव्हापासून दोन्ही कंपनीचा व्यवसाय एकत्रीत रित्या वर नमुद पत्त्यावरील कंपनीच्या कार्यालयातून माझ्या देखरेखीखाली करण्यात येत आहे. संगीता एव्हीएशन या कंपनीच्या विरुद्ध थकबाकी देय असल्याकारणाने एका कंपनीने एन.सी.एल.टी. येथे इन्सॉल्व्हन्सी पीटीशन दाखल केले होते. त्यानुसार मा. एन.सी.एल.टी. प्राधिकरणाने संगीता एव्हीएशन या कंपनीस दिवाळखोर म्हणून दिनांक 10/08/2021 रोजी घोषित केले होते. त्याविरुद्ध कंपनीच्या वतीने अपीलिय प्राधिकरणाकडे दाद मागण्यात आली असून त्याची सुनावणी चालू आहे. त्यामुळे संगीता एव्हीएशन या कंपनीच्या सर्व आर्थिक व्यवहारांवर मा. एन.सी.एल.टी. प्राधिकरणाने नेमलेल्या आय.आर.पी. श्री बिजेन्द्र झा यांची देखरेख आहे.

सन-2014 मध्ये आमच्या कंपनीमध्ये श्री. वरुण रमेश काकरीया, रा.ठी. बि विंग, शरयु बिल्डींग, सुचीघाम, फिल्म सिटी रोड, मालाड

स.पो.आयुक्त व्ही.नि.पो.नि.गुन्हे  
26 APR 2023 26 APR 2023 26 APR 2023

(पुर्व), मुंबई याची नेमणुक सदर कंपनीमध्ये सहाय्यक म्हणून करण्यात आली होती.

सन-2016 साली आमच्या कंपनीमध्ये श्री कमलेश भैरव-तातावत, रा.तौ. 89/डी, नारायण विहार-1, जगन्नाथपुर, संगानेर, जयपुर, राजस्थान याची चिफ फायनान्स आॅफिसर म्हणून नियुक्ती केली होती. तसेच त्याचा चुलतभाऊ मुकेश भैरव -तातावत याची नियुक्ती चिफ आॅपरेशन आॅफिसर म्हणून केली होती.

दोन्ही कंपन्या वेळोवेळी सरकारच्या विविध खात्यातर्फे जाहीर करण्यात आलेल्या प्रकल्पात ठेकदार म्हणून सहभागी होत असतात. सदर कंत्राट मिळविण्या करीता करावयाची संपुर्ण प्रक्रीया, त्या करीता आवश्यक असलेले सर्व कागदोपत्री व्यवहार, वेळोवेळी संबधीत सरकारी अधिका-या समवेत संपर्क ठेवणे, कंत्रट पुर्ण करण्या करीता विविध व्यवसायीकांची मदत घेणे, कंत्राटा प्रमाणे नेमुन दिलेले काम पुर्ण करणे, सरकारी कार्यालयातुन येणे असलेल्या रकमेचा पाठपुरावा करणे, कंपनी तर्फे विविध व्यवसायीकांना देय असलेली रक्कम अदा करणे इत्यादी अनेक कार्य व्यवसाया निमीत्त करावी लागतात. या सर्व कामाची जबाबदारी श्री. कमलेश तातावत आणि श्री. वरुण काकरीया यांच्यावर सोपविण्यात आली होती, त्या प्रमाणे ते दोघेजण कंपनीतील कामकाज करीत होते.

माझे पुर्वीचे मित्र स्वप्नील चव्हाण आणि अतुल पांडे हे सुध्दा वर नमुद पत्त्यावरील कंपनीच्या कार्यालयात नेहमी येत-जात होते. आमच्या दोन्ही कंपनीचे एच.डी.एफ.सी बँक, बँक आॅफ इंडिया, पंजाब नॅशनल बँक, सिटी बँक, डी.सी.बी बँक इत्यादी बँकेमध्ये बँक खाते आहेत. सदर बँक खात्याचा तपशील खालील प्रमाणे आहे.

Bank Name  
Account Number  
M/s Supreme Transport Origination Pvt. Limited  
HDFC  
10452840000014

HDFC  
03302840000157

HDFC  
01662840000470

HDFC  
03302840000140

04072840000053

HDFC  
00602340000085

PNB  
10451131002901

BOI  
843720110000498  
843720110000498  
BOI  
004420110000823

श्री. अमीत कमल अगरवाल, वय 34 वर्षे यांचा जबाब पुढे चालू.....

Bank Name  
Account Number  
M/s Sangeeta Aviation Services Pvt. Ltd  
Development Credit Bank

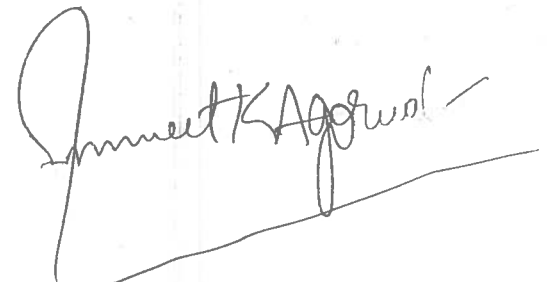
4. 

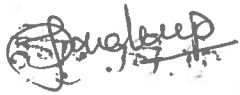

RECEIVED BY  
2016/11/14

(Customer ID  
102173678)  
00421300002745

HDFC  
50200008133578

Citi Bank  
0060246114

Punjab National Bank  
10454015001858

तसेच कंपनीच्या व्यवहारातील सुलभते करीता माझे व्यक्तीगत बँक खाती कंपनीच्या कार्यालयातुन वेळोवेळी वापरण्यात येत असतात. माझ्या वैयक्तीक बँक खात्याचा तपशील खालील प्रमाणे

Bank Name  
Account Number  
Mr. Ammeet K. Agarwal  
Development Credit Bank  
00410200001403

PNB  
10452191004874

वर नमुद केलेली सर्व बँक खाती व्यवहारीक सुलभते करीता नेट बँकींगच्या माध्यमातुन वापरली जातात. उपरोक्त HDFC बँक खात्यापैकी सुप्रिम ट्रान्सपोर्ट प्रा लि कंपनीच्या भ्रष्ट बँकेतील सर्व खात्याचा रजिस्टर्ड ईमेल आयडी हप्तपेी ; Mh girish@stopl.in आणि रजिस्टर्ड मोबाईल क्रमांक 9311701121 असा असुन सदरचा ईमेल आयडी आणि मोबाईल नंबर श्री. गिरीश अगरवाल यांच्या व्यक्तीगत वापरात आहे. तसेच इतर सर्व बँक खात्याचा रजिस्टर्ड ईमेल आय.डी.-Mh- kamlesh@supremeavaiaion.com आणि रजिस्टर्ड मोबाईल नंबर 8078655144 असा असुन तो कमलेश तातावत यांच्या व्यक्तीगत वापरात आहे. मला कंपनीच्या कामासाठी सतत पदेघात तसेच भारतातील विविध भागात जावे लागते, त्यामुळे मला कंपनीच्या दैनंदिन आर्थीक व्यवहाराचे कामकाज पाहणे शक्य नसल्यामुळे मी आमच्या दोन्ही कंपनीच्या सर्व आर्थीक व्यवहाराची तसेच माझ्या वैयक्तीक बँक खातयातील ऑनलाईन/ऑफलाईन व्यवहाराची संपुर्ण जबाबदारी सी.एफ.ओ कमलेश तातावत यांच्यावर सोपवली होती. तसेच कमलेश तातावत याला कंपनीच्या कामकाजा करीता एक स्वतंत्र लॅपटॉप आणि संगणक देण्यात आलेला होता.

मी, जुलै-2022 मध्ये कंपनीच्या आर्थीक व्यवहाराचा आढावा घेत असताना मला काही माहीती आवश्यक असल्याने मी कमलेश आणि वरुण यांना आमच्या कंपनीस येणे असलेल्या रकमेचा तपशील मागीतला होता. त्यावेळी निष्पत्ती लिमिटेड कंपनीकडुन आमच्या कंपनीला काही रक्कम येणे बाकी असल्याचे समजले. त्यामुळे मी स्वतः जुलै ते सप्टेंबर-2022 मध्ये निष्पत्ती कंपनीच्या संबंधीत अधिका-यांना अनेकवेळे ईमेल पाठवुन आमच्या कंपनीची देय असलेली रक्कम लवकरात लवकर अदा करावी अशी विनंती केली होती.

ब-याच प्रयत्ना नंतर दिनांक 26/08/2022 रोजी निष्पत्ती लिमिटेड कंपनीच्या पदाधिका-यांनी मला ईमेल पाठवुन आमच्या कंपनीला देय असलेली रक्कम आमच्या कंपनीच्या BOI A/C No843720110000498 मध्ये ट्रान्सफर केली असल्याचे कळविले होते.

मी उपरोक्त BOI बँक खात्याचे स्टेटमेंट प्राप्त करुन त्याचे अवलोकन केले असता दिनांक 26/07/2022 रोजी निष्पत्ती लिमिटेड कंपनीकडुन एकुण 03,22,616/- एवढी रक्कम बँक खात्यामध्ये क्रेडीट झाली असल्याचे आढळुन आले. परंतु दिनांक 27/07/2022 रोजी एकुण 03,23,278/- एवढी रक्कम कंपनीचे संचालक श्री. विमल अगरवाल यांच्या बँक खात्यामध्ये ट्रान्सफर करण्यात आली असल्याचे आढळुन आले.

सदर वेळी मी परदेघात असल्यामुळे सी.एफ.ओ. श्री. कमलेश तातावत यांच्याशी संपर्क साधुन त्यांच्याकडे विमल अगरवाल यांना दिनांक 27/07/2022 रोजी करण्यात आलेल्या पेमेंट बाबत विचारणा केली, परंतु त्यांनी मला कोणतीही समाधानकारक माहीती दिली नाही. सबब श्री. विमल अगरवाल यांच्याशी संपर्क केला परंतु त्यांनीही मला कोणतीही समाधान कारक माहीती दिली नाही. त्यानंतर कमलेश तातावत आणि वरुण काकरीया यांनी अचानक कंपनीच्या ऑफिसमध्ये येणे बंद केले.

श्री. विमल अगरवाल व कमलेश तातावत यांच्या एकंदरीत वर्तणुकीवरुन त्यांनी कंपनीमध्ये काहीतरी आर्थीक गैरव्यवहार केला असावा अशी शंका आल्यामुळे मी परदेशातुन भारतात आल्यानंतर आमच्या कंपनीचे चार्टर्ड अकाउंटंट श्री. गिरीष मुंदडा यांना दिनांक 06/09/2022 रोजी लेखी पत्र पाठवुन कंपनीच्या बँक खात्याची तसेच आर्थीक व्यवहाराची चौकशी/छाननी करुन त्यांनी केलेल्या चौकशी/छाननीचा निष्कर्ष कळविण्याची विनंती केली होती. त्या प्रमाणे त्यांनी आमच्या कंपनीच्या आर्थीक व्यवहाराची तपासणी करुन त्यांचा अहवाल दिनांक 02/03/2023 रोजी वरिष्ठ पोलीस निरीक्षक, सहार पोलीस ठाणे यांना पाठविलेला आहे. त्याची प्रत मी यासोबत सादर करीत आहे.

स.पो.आयुक्त दे.सी.नि. पो.नि. गुन्हे  
26 APR 2023 26 APR 2023 26 APR 2023

सुप्रीम ट्रान्सपोर्ट, संगीता एव्हीएषन आणि माझ्या वैयक्तिक (उपरोक्त नमुद) बँक खात्याची माहिती व बँक स्टेटमेंट घेऊन त्याचे अवलोकन केले असता भाडे आणि वेतनाच्या नावाखाली सुप्रीम ट्रान्सपोर्ट कंपनी, संगीता एव्हीएषन आणि माझ्या वैयक्तिक बँक बँक खात्यातून खालील व्यक्तींच्या बँक खात्यामध्ये एकुण 6,27,36,180/- एवढी रक्कम ट्रान्सफर झाली असल्याचे आढळून आले. सदर व्यक्तीची नावे व त्यांच्या बँक खात्याची माहिती खालील प्रमाणे आहे.

1) श्री. विमल अगरवाल यांचे HDFC Bank A/c No 02721000019875 या खात्यामध्ये दिनांक 03/04/2018 ते दिनांक 09/07/2022 या कालावधीत सुप्रीम ट्रान्सपोर्ट कंपनीच्या खात्यातून एकुण रक्कम रु. 1,86,26,908 , संगीता एव्हीएषन कंपनीच्या खात्यातून एकुण रक्कम रु. 13,93,250 आणि अमित अगरवाल यांच्या खात्यातून रु. 8,00,000 अशी एकत्रित 02,08,20,158/- इतकी रक्कम ट्रान्सफर करण्यात आले आहेत.

श्री. अमीत कमल अगरवाल, वय 34 वर्षे यांचा जबाब पुढे चालू.....

2) श्रीमती नूपुर विमल अगरवाल यांचे HDFC Bank A/c No 02721000018984 या खात्यामध्ये दिनांक 16/01/2018 ते दिनांक 06/07/2022 या कालावधीत सुप्रीम ट्रान्सपोर्ट कंपनीच्या खात्यातून एकुण रक्कम रु. 22,14,824 , संगीता एव्हीएषन कंपनीच्या खात्यातून एकुण रक्कम रु. 8,17,600 आणि अमित अगरवाल यांच्या खात्यातून रु. 8,00,000 अशी एकत्रित 38,32,424. इतकी रक्कम ट्रान्सफर करण्यात आले आहेत.

3) श्री. गिरीश जगदीशप्रसाद अगरवाल यांचे 02721000019892 या खात्यामध्ये दिनांक 22/06/2018 ते दिनांक 06/07/2022 या कालावधीत सुप्रीम ट्रान्सपोर्ट कंपनीच्या खात्यातून एकुण रक्कम रु. 11,05,072 , संगीता एव्हीएषन कंपनीच्या खात्यातून एकुण रक्कम रु. 13,93,250 आणि अमित अगरवाल यांच्या खात्यातून रु. 8,00,000 अशी एकत्रित 32,98,332. इतकी रक्कम ट्रान्सफर करण्यात आले आहेत.

4) श्रीमती समीक्षा गिरीश अगरवाल यांचे HDFC Bank A/c No 02721000070214 या खात्यामध्ये दिनांक 22/06/2018 ते दिनांक 06/07/2022 या कालावधीत सुप्रीम ट्रान्सपोर्ट कंपनीच्या खात्यातून एकुण रक्कम रु. 08,79,970 , संगीता एव्हीएषन कंपनीच्या खात्यातून एकुण रक्कम रु. 10,95,500 आणि अमित अगरवाल यांच्या खात्यातून रु. 8,00,000 अशी एकत्रित 27,75,470घ. इतकी रक्कम ट्रान्सफर करण्यात आले आहेत.

5) श्रीमती पिकी जगदीशप्रसाद अगरवाल यांचे HDFC Bank A/c No02721000055437 या खात्यामध्ये दिनांक 04/05/2018 ते दिनांक 06/07/2022 या कालावधीत सुप्रीम ट्रान्सपोर्ट कंपनीच्या खात्यातून एकुण रक्कम रु. 11,94,970 , संगीता एव्हीएषन कंपनीच्या खात्यातून एकुण रक्कम रु. 8,77,150 आणि अमित अगरवाल यांच्या खात्यातून रु. 7,86,611 अशी एकत्रित 28,58,700/-रक्कम ट्रान्सफर करण्यात आले आहेत.

6) श्री. अतुल सुरेद्र पांडे यांचेHDFC Bank A/c No 12111140000459 या खात्यामध्ये दिनांक 31/08/2019 ते दिनांक 15/12/2021 या कालावधीत एकुण 37ए34ए000घ. इतकी रक्कम संगीता एव्हीएषन या कंपनीच्या बँक खात्यातून ट्रान्सफर झाले आहेत.

7) श्रीमती रजनी सुरेद्र पांडे यांचे PNB Bank A/c No 1565000100131966 या खात्यामध्ये दिनांक 09/10/2020 ते दिनांक 05/12/2020 या कालावधीत एकुण 11ए00ए000घ. इतकी रक्कम संगीता एव्हीएषन या कंपनीच्या बँक खात्यातून ट्रान्सफर झाले आहेत.

-----8) श्री. स्वप्नील बबन चव्हाण यांचेCICI Bank A/c No 104401531869 -Axis Bank A/c No921010008877100 या खात्यामध्ये दिनांक 15/11/2019 ते दिनांक 27/12/2021 या कालावधीत एकुण 45,52,400घ. इतकी रक्कम संगीता एव्हीएषन या कंपनीच्या बँक खात्यातून ट्रान्सफर झाले आहेत.

9) श्रीमती स्नेहा बबन चव्हाण यांचे Saraswat Bank A/c No013200128873557 या खात्यामध्ये दिनांक 04/07/2019 ते दिनांक 07/09/2021 या कालावधीत एकुण 47,55,000घ. इतकी रक्कम संगीता एव्हीएषन या कंपनीच्या बँक खात्यातून ट्रान्सफर झाले आहेत.

10) तसेच स्वप्नील चव्हाण याने दिनांक 05/03/2017 रोजी UAE देशात "पोटोमॅक एव्हीएषन टेक्नाॅलाजी" नावाची कंपनी स्थापन केली आहे. तसेच सदर कंपनीच्या "नुर ट्रेड बँक, यु.ए.ई." येथे बँक खाते उघडले असून सदर बँक खात्याचा पत्ता मरोळ मरोषी रोड, अंधेरी (पुर्व), मुंबई येथील आहे. तसेच सुप्रीम एव्हीएषन कंपनीच्या बँक खात्यातून पोटोमॅक कंपनीच्या बँक खात्यामध्ये खालील प्रमाणे रक्कम ट्रान्सफर केली आहे.

Sr. No  
Transaction Date  
Amount

*Sanjay*

रिजिस्ट्रार जनरल, मुंबई

Value in INR  
01  
19/04/2017  
72,932.15 AED  
16,04,500/-

02  
19/04/2017  
72,983.04 AED  
16,05,000/-

Total  
32,09,500/-

11) श्री. राजेश भगवानदास अगरवाल यांच्या बँक खात्यामध्ये दिनांक 27/02/2019 ते दिनांक 04/09/2020 या कालावधीत एकुण 90,85,437.इतकी रक्कम संगीता एव्हीएशन या कंपनीच्या बँक खात्यातून ट्रान्सफर झाले आहेत.

12) श्री. राजेश भगवानदास अगरवाल यांच्या मालकीच्या बालाजी एंटरप्रायझेसच्या Bassein Catholic Co-Op Bank Ltd A/c No 012130300000051 या बँक खात्यामध्ये दिनांक 27/02/2019 ते दिनांक 04/09/2020 या कालावधीत एकुण 27,14,759. इतकी रक्कम संगीता एव्हीएशन या कंपनीच्या बँक खात्यातून ट्रान्सफर झाले आहेत. तसेच विमल अगरवाल, नुपुर अगरवाल, गिरीश अगरवाल व पिंकी अगरवाल यांनी त्यांच्या व्यक्तिगत विदेशी प्रवासाकरीता वेळोवेळी सुप्रिम ट्रान्सपोर्ट व संगीता एव्हीएशन तसेच माझ्या बँक खात्यावर रक्कम पाठविलेल्या होत्या. परंतु त्यांचा विनायीय हा त्यांच्याच विदेश प्रवासाकरीता करण्यात आलेला होता. त्याबाबत सर्व हिशोब माझ्याकडे आहे.

वस्तुतः गेली अनेक वर्षे सुप्रिम ट्रान्सपोर्ट व संगीता एव्हीएशन या दोन्ही कंपन्या सातत्याने तोट्यात चालविण्यात येत आहेत. त्यामुळे मी सन 2012 सालापासून ते आजपावेतो कंपनीच्या खात्यामधून कोणताही आर्थिक मोबदला घेतलेला नाही. तसेच माझे वडील श्री कमल अगरवाल माझा सख्खा धाकटा भाऊ आकाश अगरवाल यांनीही कोणताही आर्थिक मोबदला घेतलेला नाही. त्यामुळे वर नमुद केल्यानुसार श्री विमल अगरवाल आणि इतरांच्या खात्यामध्ये एवढी प्रचंड रक्कम सन 2018 ते 2022 या कालावधीत टप्प्या टप्प्याने वळती करण्यामागे त्यांचा लबाडीचा उद्येस असल्याचे स्पष्ट दिसून येते. तसेच सदरची रक्कम वळती केल्याबाबत मला या

श्री. अमीत कमल अगरवाल, वय 34 वर्षे यांचा जबाब पुढे चालु.....

कालावधीत कमलेश तातावत आणि वरुण काकरिया यांच्याकडूनही कोणतीही पुर्वकल्पना प्राप्त झालेली नव्हती. त्यावरून विमल अगरवाल आणि इतर लाभार्थी तसेच कमलेश तातावत आणि वरुण काकरिया यांच्यात आपआपसात संगणमत असल्याचेही मला स्पष्ट झाले आहे.

मी कंपनीचे संचालक श्री. विमल अगरवाल, श्री. गिरीश अगरवाल, स्वप्नील चव्हाण, अतुल पांडे व राजेश अगरवाल यांच्याशी संपर्क साधण्याचा वारंवार प्रयत्न केला परंतु त्यांनी कोणताही प्रतिसाद दिलेला नाही. चलटपक्षी दिनांक 11/11/2022 रोजी श्री. विमल अगरवाल व श्री. गिरीश अगरवाल यांनी एन.सी.एल.टी (नॅशनल कंपनी लाॅ ट्रिब्युनल), मुंबई यांच्याकडे खटला दाखल करून सदर खटल्यामध्ये दिनांक 01/04/2019 पासून सुप्रिम ट्रान्सपोर्ट कंपनीने त्यांना कोणत्याही प्रकारचे मानधन दिले नाही असा दावा केला आहे.

(1) विमल अगरवाल (2) नुपुर अगरवाल (3) गिरीश अगरवाल (4) समीक्षा अगरवाल (5) पिंकी अगरवाल (6) स्वप्नील चव्हाण (7) स्नेहा चव्हाण (8) अतुल पांडे व (9) रजनी पांडे, (10) राजेश भगवानदास अगरवाल तसेच इतर काही व्यक्तींनी आणखीन काही रकमेचा अपहार केला असण्याची शक्यता असून त्या अनुषंगाने कंपनीतील आर्थिक व्यवहाराची बारकाईने छाननी/पडताळणी करण्यात येत आहे. पडताळणी दरम्यान नमुद व्यक्तींनी आणखीन काही रकमेचा अपहार केल्याचे निदर्शनास येताच तात्काळ सहार पोलीस ठाणेस कळविण्यात येईल.

तरी सुप्रिम ट्रान्सपोर्ट प्रा लि या कंपनीचे संचालक (1) श्री. विमल अगरवाल व (2) गिरीश अगरवाल आणि सी.एफ.ओ (3) कमलेश भैरव तातावत यांनी एप्रिल-2018 ते जुलै-2022 या कालावधीत आपसात संगणमत करून त्यांच्या वैयक्तिक आर्थिक फायद्या करीता भाडे आणि वेतनाच्या नावाखाली सुप्रिम ट्रान्सपोर्ट, संगीता एव्हीएशन सर्विस व माझ्या वैयक्तिक बँक खात्यातून खात्यातून एकुण 6,27,36,180/- रुपये एवढी रक्कम (1) विमल अगरवाल (2) नुपुर अगरवाल (3) गिरीश अगरवाल (4) समीक्षा अगरवाल (5) पिंकी अगरवाल (6) स्वप्नील चव्हाण (7) स्नेहा चव्हाण (8) अतुल पांडे व (9) रजनी पांडे, (10) राजेश भगवानदास अगरवाल यांच्या बँक खात्यामध्ये ट्रान्सफर करून एकुण 6,27,36,180/- एवढ्या रकमेचा अपहार करून फसवणुक केली आहे, म्हणून माझी त्यांचे विरुद्ध तक्रार असून कायदेशिर कारवाई होण्यास विनंती आहे.

13. Action Since the above information reveals commission of offence(s) u/s as mentioned at (केलेली कारवाई: बाब क्र.२ मध्ये नमूद केलेल्या कलमान्वये वरील अहवालावरून अपराध घडल्याचे.)

- (1) Registered the case and took up the investigation: (प्रकरण नोंदविले आणि तपासाचे काम हाती घेतले): or (किंवा)
- (2) Directed (Name of I.O.) (तपास अधिका-याचे नाव): SANDEEP LAXMAN SHINDE  
Rank (पद): I (Inspector)  
No.(क्र.): PBMAH85460 to take up the Investigation (ला तपास करण्याचे अधिकार दिले) or (किंवा)
- (3) Refused investigation due to (ज्या कारणामुळे तपास करण्यास नकार दिला):

or (ज्या कारणामुळे तपास करण्यास नकार दिला)

- (4) Transferred to P.S.(गुन्हा दुसरीकडे पाठविला असल्यास त्या पोलीस ठाण्याचे नाव):  
District (जिल्हा):  
on point of jurisdiction (को क्षेत्राधिकार के कारण हस्तांतरित) .

F.I.R. read over to the complainant / informant, admitted to be correctly recorded and a copy given to the complainant / informant free of cost. (प्रथम खबर तक्रारदाराला/खबरीला वाचून दाखविली, बरोबर नोंदविली असल्याचे त्याने मान्य केले आणि तक्रारदाराला/खबरीला खबरीची प्रत मोफत दिली.)

R.O.A.C.(आर. ओ .ए .सी.)

14. Signature/Thumb impression of the complainant / informant.(तक्रारदाराची/खबर देणा-याची सही/अंगठा):

15. Date and time of dispatch to the court (न्यायालयात पाठवल्याची तारीख व वेळ):

*Immet K Agawal*

*Sandeep*  
ठाणे अंमलदार  
सहार पोलीस ठाणे  
मुंबई  
Signature of Officer in charge, Police Station (किंवा) अंमलदारी अधिका-याची  
Name (नाव): Sanjay yashwant govilkar  
Rank(पद): I (Inspector)  
No.(सं.): 10

स.पो. आयुक्त र.पो.नि.पो.नि.गुन्हे  
26 APR 2023 26 APR 2023 26 APR 2023

जबाब

दिनांक २५/०४/२०२३

श्री. अमीत कमल अगरवाल, वय ३४ वर्षे, धंदा—व्यवसाय, रा.ठी. ९०१ बिकानेर भवन, जे.बी. नगर, अंधेरी (पुर्व), मुंबई (मोबा—९८७०८११२२४)

मी, वरील प्रमाणे असुन वर नमुद पत्त्यावर माझे वडील श्री. कमल अगरवाल व आई श्रीमती संगीता अगरवाल यांच्या सोबत रहावयास आहे. माझे वडील श्री. कमल अगरवाल यांनी सन—२००८ मध्ये सुप्रिम ट्रान्सपोर्ट प्रा लि या नावाची कंपनी सुरु केलेली आहे. मी संगीता एव्हीएशन सर्विस प्रा लि या कंपनीची स्थापना सन—२०१२ मध्ये केलेली आहे. या दोन्ही कंपन्यामध्ये मी अध्यक्ष आणि कार्यकारी संचालक म्हणुन सध्या कार्यरत आहे. दोन्ही कंपनीचे ऑसिफ ५/बी—३४, ५/बी—३२ अक्षय मित्तल इंडस्ट्रीयल इस्टेट, अंधेरी कुर्ला रोड, अंधेरी (पुर्व), मुंबई या ठिकाणी आहे.

कंपनीचे संचालक (१) श्री. विमल अगरवाल व (२) गिरीष अगरवाल आणि कंपनीचे सी.एफ.ओ (३) कमलेश भैरव—तातावत यांनी आपसात संगणमत करुन एप्रिल—२०१८ ते जुलै—२०२२ या कालावधीत भाडे आणि वेतनाच्या नावाखाली कंपनीच्या एकुण ५ कोटी रुपयांचा अपहार केला असल्याबाबत मी डिसेंबर—२०२२ मध्ये मा. पोलीस सह आयुक्त, आर्थिक गुन्हे शाखा, मुंबई यांच्याकडे तक्रार केली होती, परंतु त्यांनी माझी तक्रार स्थानीक पोलीस ठाण्याकडे पाठवली असल्याचे कळविलेले आहे. सबब मी दिनांक ०७/०१/२०२३ रोजी सहार पोलीस ठाणे येथे लेखी तक्रार केली असुन त्या अनुषंगाने मी खालील प्रमाणे सविस्तर जबाब देत आहे.

सुप्रिम ट्रान्सपोर्ट प्रा लि या कंपनीमध्ये मी स्वतः, तसेच माझे वडील श्री. कमल अगरवाल, माझा सख्खा धाकटा भाऊ श्री. आकाश अगरवाल आणि श्री. विमल अगरवाल व श्री. गिरीष अगरवाल असे एकुण ०५ संचालक आहेत. सदर कंपनीचा मुख्य व्यवसाय मालाची रस्ते वाहतुक आणि हवाई वाहतुक करण्याचा आहे. कंपनीच्या मालकीची काही वाहने व विमान आहे. या व्यतीरीक्त कंपनीच्या व्यवसाया करीता आवश्यकते नुसार भाडे तत्वावर वाहने घेतली जातात. सदर कंपनीचे मुख्य कार्यालय मुंबईमध्ये असुन पनवेल, कळंबोली, राजस्थान, गुजरात, दिल्ली आणि बेंगलोर या ठिकाणी शाखा व विभागीय कार्यालये आहेत.

संचालकापैकी श्री. विमल अगरवाल हे बेंगलोर येथे रहावयास आहेत. श्री. गिरीष अगरवाल हे दिल्ली येथे रहावयास आहेत. ते दोघेही नात्याने माझे चुलतभाऊ आहेत. त्यांचे दिवंगत वडील कै. जगदीशप्रसाद अगरवाल माझ्या वडीलांचे सख्खे मोठे भाऊ होते. कै. जगदीशप्रसाद अगरवाल यांच्या मृत्यु नंतर श्री. विमल अगरवाल आणि श्री गिरीष अगरवाल यांची परस्परातील सहमती नुसार सुप्रिम ट्रान्सपोर्ट कंपनीमध्ये संचालक म्हणुन नियुक्ती करण्यात आली आहे. ते दोघेही प्रत्येक महीन्यातील काही दिवस मुंबईमध्ये राहुन कंपनीच्या दैनदिन कामकाजात सहभागी होत असत.

कृपया मागे पहा.....

स.पो.आयुक्त व.बी.नि.पो.नि.गुन्हे  
26 APR 2023 26 APR 2023 26 APR 2023

सुप्रिम ट्रान्सपोर्ट प्रा लि. ही कंपनी तोटयात व्यवसाय करीत असल्यामुळे सन-२०१२ साली आमच्या कुंडुबातील आपसातील समझौत्या नुसार माझी सदर कंपनीमध्ये कार्यकारी संचालक आणि अध्यक्ष म्हणुन नेमणुक करण्यात आली आहे. तेव्हापासुन दोन्ही कंपनीचा व्यवसाय एकत्रीत रित्या वर नमुद पत्त्यावरील कंपनीच्या कार्यालयातुन माझ्या देखरेखीखाली करण्यात येत आहे. संगीता एव्हिएशन या कंपनीच्या विरूध्द थकबाकी देय असल्याकारणाने एका कंपनीने एन.सी.एल.टी. येथे इन्सॉलव्हन्सी पीटीशन दाखल केले होते. त्यानुसार मा. एन.सी.एल.टी. प्राधिकरणाने संगीता एव्हिएशन या कंपनीस दिवाळखोर म्हणुन दिनांक १०/०८/२०२१ रोजी घोषित केले होते. त्याविरूध्द कंपनीच्या वतीने अपीलिय प्राधिकरणाकडे दाद मागण्यात आली असुन त्याची सुनावणी चालू आहे. त्यामुळे संगीता एव्हिएशन या कंपनीच्या सर्व आर्थिक व्यवहारांवर मा. एन.सी.एल.टी. प्राधिकरणाने नेमलेल्या आय.आर.पी. श्री बिजेन्द्र झा यांची देखरेख आहे.

सन-२०१४ मध्ये आमच्या कंपनीमध्ये श्री. वरुण रमेश काकरीया, रा.ठी. बि विंग, शरयु बिल्डींग, सुचीधाम, फिल्म सिटी रोड, मालाड (पुर्व), मुंबई याची नेमणुक सदर कंपनीमध्ये सहाय्यक म्हणुन करण्यात आली होती.

सन-२०१६ साली आमच्या कंपनीमध्ये श्री कमलेश भैरव-तातावत, रा.ठी. ८९/डी, नारायन विहार-१, जगन्नाथपुर, संगानेर, जयपुर, राजस्थान याची चिफ फायनान्स ऑफिसर म्हणुन नियुक्ती केली होती. तसेच त्याचा चुलतभाऊ मुकेश भैरव -तातावत याची नियुक्ती चिफ ऑपरेशन ऑफिसर म्हणुन केली होती.

दोन्ही कंपन्या वेळोवेळी सरकारच्या विविध खात्यातर्फे जाहीर करण्यात आलेल्या प्रकल्पात ठेकदार म्हणुन सहभागी होत असतात. सदर कंत्राट मिळविण्या करीता करावयाची संपुर्ण प्रक्रीया, त्या करीता आवश्यक असलेले सर्व कागदोपत्री व्यवहार, वेळोवेळी संबंधीत सरकारी अधिकाऱ्या समवेत संपर्क ठेवणे, कंत्राट पुर्ण करण्या करीता विविध व्यवसायीकांची मदत घेणे, कंत्राटा प्रमाणे नेमुन दिलेले काम पुर्ण करणे, सरकारी कार्यालयातुन येणे असलेल्या रकमेचा पाठपुरावा करणे, कंपनी तर्फे विविध व्यवसायीकांना देय असलेली रक्कम अदा करणे इत्यादी अनेक कार्य व्यवसाया निमीत्त करावी लागतात. या सर्व कामाची जबाबदारी श्री. कमलेश तातावत आणि श्री. वरुण काकरीया यांच्यावर सोपविण्यात आली होती, त्या प्रमाणे ते दोघेजण कंपनीतील कामकाज करीत होते.

माझे पुर्वीचे मित्र स्वप्नील चव्हाण आणि अतुल पांडे हे सुध्दा वर नमुद पत्त्यावरील कंपनीच्या कार्यालयात नेहमी येत-जात होते. आमच्या दोन्ही कंपनीचे एच.डी. एफ.सी बँक, बँक ऑफ इंडिया, पंजाब नॅशनल बँक, सिटी बँक, डी.सी.बी बँक इत्यादी बँकेमध्ये बँक खाते आहेत. सदर बँक खात्याचा तपशील खालील प्रमाणे आहे.

	Bank Name	Account Number
M/s Supreme Transport Origination Pvt. Limited	HDFC	10452840000014
	HDFC	03302840000157
	HDFC	01662840000470
	HDFC	03302840000140
	HDFC	04072840000053
	HDFC	00602340000085
	PNB	10451131002901
	BOI	843720110000498
	BOI	004420110000823

*Sanjay*

*Sanjay* पुर्वे चालू.....

श्री. अमीत कमल अगरवाल, वय ३४ वर्षे यांचा जबाब पुढे चालू.....

	Bank Name	Account Number
M/s Sangeeta Aviation Services Pvt. Ltd	Development Credit Bank (Customer ID 102173678)	00421300002745
	HDFC	50200008133578
	Citi Bank	0060246114
	Punjab National Bank	10454015001858

तसेच कंपनीच्या व्यवहारातील सुलभते करिता माझे व्यक्तीगत बँक खाती कंपनीच्या कार्यालयातून वेळोवेळी वापरण्यात येत असतात. माझ्या वैयक्तिक बँक खात्याचा तपशील खालील प्रमाणे

	Bank Name	Account Number
Mr. Ammeet K. Agarwal	Development Credit Bank	00410200001403
	PNB	10452191004874

वर नमुद केलेली सर्व बँक खाती व्यवहारीक सुलभते करिता नेट बँकींगच्या माध्यमातून वापरली जातात. उपरोक्त बँक खात्यापैकी सुप्रिम ट्रान्सपोर्ट प्रा लि कंपनीच्या HDFC बँकेतील सर्व खात्याचा रजिस्टर्ड ईमेल आयडी girish@stopl.in आणि रजिस्टर्ड मोबाईल क्रमांक 9311701121 असा असुन सदरचा ईमेल आयडी आणि मोबाईल नंबर श्री. गिरीष अगरवाल यांच्या व्यक्तीगत वापरात आहे. तसेच इतर सर्व बँक खात्याचा रजिस्टर्ड ईमेल आयडी. kamlesh@supremeavaiaation.com आणि रजिस्टर्ड मोबाईल नंबर 8078655144 असा असुन तो कमलेश तातावत यांच्या व्यक्तीगत वापरात आहे. मला कंपनीच्या कामासाठी सतत पदेशात तसेच भारतातील विविध भागात जावे लागते, त्यामुळे मला कंपनीच्या दैनंदिन आर्थिक व्यवहाराचे कामकाज पाहणे शक्य नसल्यामुळे मी आमच्या दोन्ही कंपनीच्या सर्व आर्थिक व्यवहाराची तसेच माझ्या वैयक्तिक बँक खात्यातील ऑनलाईन/ऑफलाईन व्यवहाराची संपुर्ण जबाबदारी सी.एफ.ओ कमलेश तातावत याच्यावर सोपवली होती. तसेच कमलेश तातावत याला कंपनीच्या कामकाजा करिता एक स्वतंत्र लॅपटॉप आणि संगणक देण्यात आलेला होता.

मी, जुलै-२०२२ मध्ये कंपनीच्या आर्थिक व्यवहाराचा आढावा घेत असताना मला काही माहिती आवश्यक असल्याने मी कमलेश आणि वरुण यांना आमच्या कंपनीस येणे असलेल्या रकमेचा तपशील मागीतला होता. त्यावेळी निष्पॉन लिमिटेड कंपनीकडून आमच्या कंपनीला काही रक्कम येणे बाकी असल्याचे समजले. त्यामुळे मी स्वतः जुलै ते सप्टेंबर-२०२२ मध्ये निष्पॉन कंपनीच्या संबंधित अधिकाऱ्यांना अनेकवेळ ईमेल पाठवून आमच्या कंपनीची देय असलेली रक्कम लवकरात लवकर अदा करावी अशी विनंती केली होती.

स.पो. आयुक्त व.पो.नि. पो.नि. शुन्हे  
26 APR 2023 26 APR 2023 कृपया मागे पहा.....

बन्याच प्रयत्ना नंतर दिनांक २६/०८/२०२२ रोजी निष्पान लिमिटेड कंपनीच्या पदाधिकार्यांनी मला ईमेल पाठवुन आमच्या कंपनीला देय असलेली रक्कम आमच्या कंपनीच्या BOI A/C No 843720110000498 मध्ये ट्रान्सफर केली असल्याचे कळविले होते.

मी उपरोक्त BOI बँक खात्याचे स्टेटमेंट प्राप्त करुन त्याचे अवलोकन केले असता दिनांक २६/०७/२०२२ रोजी निष्पान लिमिटेड कंपनीकडुन एकुण ०३,२२,६१६/- एवढी रक्कम बँक खात्यामध्ये क्रेडीट झाली असल्याचे आढळुन आले. परंतु दिनांक २७/०७/२०२२ रोजी एकुण ०३,२३,२७८/- एवढी रक्कम कंपनीचे संचालक श्री. विमल अगरवाल यांच्या बँक खात्यामध्ये ट्रान्सफर करण्यात आली असल्याचे आढळुन आले.

सदर वेळी मी परदेशात असल्यामुळे सी.एफ.ओ. श्री. कमलेश तातावत यांच्याशी संपर्क साधुन त्यांच्याकडे विमल अगरवाल यांना दिनांक २७/०७/२०२२ रोजी करण्यात आलेल्या पेमेंट बाबत विचारणा केली, परंतु त्यांनी मला कोणतीही समाधानकारक माहिती दिली नाही. सबब श्री. विलम अगरवाल यांच्याशी संपर्क केला परंतु त्यांनीही मला कोणतीही समाधान कारक माहिती दिली नाही. त्यांनतर कमलेश तातावत आणि वरुण काकरीया यांनी अचानक कंपनीच्या ऑफिसमध्ये येणे बंद केले.

श्री. विमल अगरवाल व कमलेश तातावत यांच्या एकंदरीत वर्तणुकीवरुन त्यांनी कंपनीमध्ये काहीतरी आर्थिक गैरव्यवहार केला असावा अशी शंका आल्यामुळे मी परदेशातुन भारतात आल्यांनतर आमच्या कंपनीचे चार्टर्ड अकाऊंटंट श्री. गिरीष मुंदडा यांना दिनांक ०६/०९/२०२२ रोजी लेखी पत्र पाठवुन कंपनीच्या बँक खात्याची तसेच आर्थिक व्यवहाराची चौकशी/छाननी करुन त्यांनी केलेल्या चौकशी/छाननीचा निष्कर्ष कळविण्याची विनंती केली होती. त्या प्रमाणे त्यांनी आमच्या कंपनीच्या आर्थिक व्यवहाराची तपासणी करुन त्यांचा अहवाल दिनांक ०२/०३/२०२३ रोजी वरिष्ठ पोलीस निरिक्षक, सहार पोलीस ठाणे यांना पाठविलेला आहे. त्याची प्रत मी यासोबत सादर करीत आहे.

सुप्रीम ट्रान्सपोर्ट, संगीता एव्हीएशन आणि माइया वैयक्तीक (उपरोक्त नमुद) बँक खात्याची माहिती व बँक स्टेटमेंट घेऊन त्याचे अवलोकन केले असता भाडे आणि वेतनाच्या नावाखाली सुप्रीम ट्रान्सपोर्ट कंपनी, संगीता एव्हीएशन आणि माइया वैयक्तीक बँक बँक खात्यातुन खालील व्यक्तींच्या बँक खात्यामध्ये एकुण ६,२७,३६,१८०/- एवढी रक्कम ट्रान्सफर झाली असल्याचे आढळुन आले. सदर व्यक्तीची नावे व त्यांच्या बँक खात्याची माहिती खालील प्रमाणे आहे.

१) श्री. विमल अगरवाल यांचे HDFC Bank A/c No 02721000019875 या खात्यामध्ये दिनांक ०३/०४/२०१८ ते दिनांक ०९/०७/२०२२ या कालावधीत सुप्रीम ट्रान्सपोर्ट कंपनीच्या खात्यातुन एकुण रक्कम रू. १,८६,२६,९०८ , संगीता एव्हीएशन कंपनीच्या खात्यातुन एकुण रक्कम रू. १३,९३,२५० आणि अमित अगरवाल यांच्या खात्यातुन रू. ८,००,००० अशी एकत्रित ०२,०८,२०,१५८/- इतकी रक्कम ट्रान्सफर करण्यात आले आहेत.

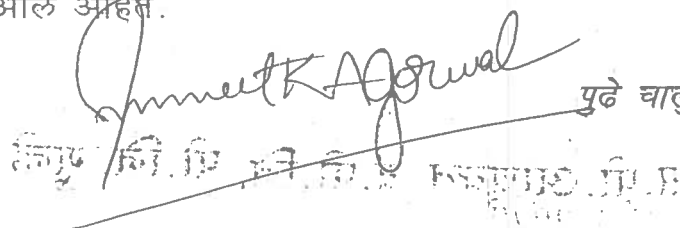

  
पुढे चालु .....

श्री. अमीत कमल अगरवाल, वय ३४ वर्षे यांचा जबाब पुढे चालू.....

२) श्रीमती नुपुर विमल अगरवाल यांचे HDFC Bank A/c No 02721000018984 या खात्यामध्ये दिनांक १६/०१/२०१८ ते दिनांक ०६/०७/२०२२ या कालावधीत सुप्रिम ट्रान्सपोर्ट कंपनीच्या खात्यातुन एकुण रक्कम रू. २२,१४,८२४ , संगीता एव्हीएशन कंपनीच्या खात्यातुन एकुण रक्कम रू. ८,१७,६०० आणि अमित अगरवाल यांच्या खात्यातुन रू. ८,००,००० अशी एकत्रित ३८,३२,४२४/- इतकी रक्कम ट्रान्सफर करण्यात आले आहेत.

३) श्री. गिरीष जगदीशप्रसाद अगरवाल यांचे HDFC Bank A/c No 02721000019892 या खात्यामध्ये दिनांक २२/०६/२०१८ ते दिनांक ०६/०७/२०२२ या कालावधीत सुप्रिम ट्रान्सपोर्ट कंपनीच्या खात्यातुन एकुण रक्कम रू. ११,०५,०७२ , संगीता एव्हीएशन कंपनीच्या खात्यातुन एकुण रक्कम रू. १३,९३,२५० आणि अमित अगरवाल यांच्या खात्यातुन रू. ८,००,००० अशी एकत्रित ३२,९८,३३२/- इतकी रक्कम ट्रान्सफर करण्यात आले आहेत.

४) श्रीमती समीक्षा गिरीष अगरवाल यांचे HDFC Bank A/c No 02721000070214 या खात्यामध्ये दिनांक २२/०६/२०१८ ते दिनांक ०६/०७/२०२२ या कालावधीत सुप्रिम ट्रान्सपोर्ट कंपनीच्या खात्यातुन एकुण रक्कम रू. ०८,७९,९७० , संगीता एव्हीएशन कंपनीच्या खात्यातुन एकुण रक्कम रू. १०,९५,५०० आणि अमित अगरवाल यांच्या खात्यातुन रू. ८,००,००० अशी एकत्रित २७,७५,४७०/- इतकी रक्कम ट्रान्सफर करण्यात आले आहेत.

५) श्रीमती पिकी जगदीशप्रसाद अगरवाल यांचे HDFC Bank A/c No 02721000055437 या खात्यामध्ये दिनांक ०४/०५/२०१८ ते दिनांक ०६/०७/२०२२ या कालावधीत सुप्रिम ट्रान्सपोर्ट कंपनीच्या खात्यातुन एकुण रक्कम रू. ११,९४,९७० , संगीता एव्हीएशन कंपनीच्या खात्यातुन एकुण रक्कम रू. ८,७७,१५० आणि अमित अगरवाल यांच्या खात्यातुन रू. ७,८६,६११ अशी एकत्रित २८,५८,७००/- रक्कम ट्रान्सफर करण्यात आले आहेत.

६) श्री. अतुल सुरेद्र पांडे यांचे HDFC Bank A/c No 12111140000459 या खात्यामध्ये दिनांक ३१/०८/२०१९ ते दिनांक १५/१२/२०२१ या कालावधीत एकुण ३७,३४,०००/- इतकी रक्कम संगीता एव्हीएशन या कंपनीच्या बँक खात्यातुन ट्रान्सफर झाले आहेत.

७) श्रीमती रजनी सुरेद्र पांडे यांचे PNB Bank A/c No 1565000100131966 या खात्यामध्ये दिनांक ०९/१०/२०२० ते दिनांक ०५/१२/२०२० या कालावधीत एकुण ११,००,०००/- इतकी रक्कम संगीता एव्हीएशन या कंपनीच्या बँक खात्यातुन ट्रान्सफर झाले आहेत.

८) श्री. स्वप्नील बबन चव्हाण यांचे ICICI Bank A/c No 104401531869 & Axis Bank A/c No 921010008877100 या खात्यामध्ये दिनांक १५/११/२०१९ ते दिनांक २७/१२/२०२१ या कालावधीत एकुण ४५,५२,४००/- इतकी रक्कम संगीता एव्हीएशन या कंपनीच्या बँक खात्यातुन ट्रान्सफर झाले आहेत.

कृपया मागे पहा.....

28 APR 2023 6 APR 2023  
स. मा. आयुक्त व. पी. नि. पो. नि. गुन्हे

९) श्रीमती स्नेहा बबन चव्हाण यांचे Saraswat Bank A/c No 013200128873557 या खात्यामध्ये दिनांक ०४/०७/२०१९ ते दिनांक ०७/०९/२०२१ या कालावधीत एकुण 47,55,000/- इतकी रक्कम संगीता एव्हीएशन या कंपनीच्या बँक खात्यातून ट्रान्सफर झाले आहेत.

१०) तसेच स्वप्नील चव्हाण याने दिनांक ०५/०३/२०१७ रोजी UAE देशात "पोटोमॅक एव्हीएशन टेक्नॉलाजी" नावाची कंपनी स्थापन केली आहे. तसेच सदर कंपनीच्या "नुर ट्रेड बँक, यु.ए.ई" येथे बँक खाते उघडले असून सदर बँक खात्याचा पत्ता मरोळ मरोशी रोड, अंधेरी (पुर्व), मुंबई येथील आहे. तसेच सुप्रीम एव्हीएशन कंपनीच्या बँक खात्यातून पोटोमॅक कंपनीच्या बँक खात्यामध्ये खालील प्रमाणे रक्कम ट्रान्सफर केली आहे.

Sr. No	Transaction Date	Amount	Value in INR
01	19/04/2017	72,932.15 AED	16,04,500/-
02	19/04/2017	72,983.04 AED	16,05,000/-
		Total	32,09,500/-

११) श्री. राजेश भगवानदास अगरवाल यांच्या बँक खात्यामध्ये दिनांक २७/०२/२०१९ ते दिनांक ०४/०९/२०२० या कालावधीत एकुण 90,85,437/- इतकी रक्कम संगीता एव्हीएशन या कंपनीच्या बँक खात्यातून ट्रान्सफर झाले आहेत.

१२) श्री. राजेश भगवानदास अगरवाल यांच्या मालकीच्या बालाजी एंटरप्रायझेसच्या Bassein Catholic Co-Op Bank Ltd A/c No 012130300000051 या बँक खात्यामध्ये दिनांक २७/०२/२०१९ ते दिनांक ०४/०९/२०२० या कालावधीत एकुण 27,14,759/- इतकी रक्कम संगीता एव्हीएशन या कंपनीच्या बँक खात्यातून ट्रान्सफर झाले आहेत.

तसेच विमल अगरवाल, नुपुर अगरवाल, गिरीष अगरवाल व पिंकी अगरवाल यांनी त्यांच्या व्यक्तिगत विदेशी प्रवासाकरीता वेळोवेळी सुप्रीम ट्रान्सपोर्ट व संगीता एव्हीएशन तसेच माझ्या बँक खात्यावर रक्कम पाठविलेल्या होत्या. परंतु त्यांचा विनीयोग हा त्यांच्याच विदेश प्रवासाकरीता करण्यात आलेला होता. त्याबाबत सर्व हिशोब माझ्याकडे आहे.

वस्तुतः गेली अनेक वर्षे सुप्रीम ट्रान्सपोर्ट व संगीता एव्हीएशन या दोन्ही कंपन्या सातत्याने तोट्यात चालविण्यात येत आहेत. त्यामुळे मी सन २०१२ सालापासून ते आजपावेतो कंपनीच्या खात्यामधून कोणताही आर्थिक मोबदला घेतलेला नाही. तसेच माझे वडील श्री कमल अगरवाल माझा सख्खा धाकटा भाऊ आकाश अगरवाल यांनीही कोणताही आर्थिक मोबदला घेतलेला नाही. त्यामुळे वर नमुद केल्यानुसार श्री विमल अगरवाल आणि इतरांच्या खात्यामध्ये एवढी प्रचंड रक्कम सन २०१८ ते २०२२ या कालावधीत टप्प्या टप्प्याने वळती करण्यामागे त्यांचा लबाडीचा उद्येश असल्याचे स्पष्ट दिसून येते. तसेच सदरची रक्कम वळती केल्याबाबत मला या

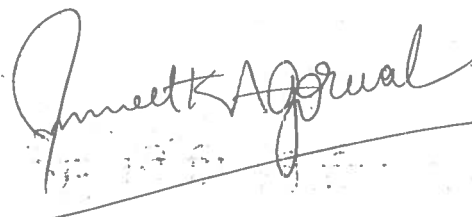

 पुढे चालु .....

श्री. अमीत कमल अगरवाल, वय ३४ वर्षे यांचा जबाब पुढे चालू.....

कालावधीत कमलेश तातावत आणि वरूण काकरीया यांच्याकडूनही कोणतीही पुर्वकल्पना प्राप्त झालेली नव्हती. त्यावरून विमल अगरवाल आणि इतर लाभार्थी तसेच कमलेश तातावत आणि वरून काकरीया यांच्यात आपआपसात संगणमत असल्याचेही मला स्पष्ट झाले आहे.

मी कंपनीचे संचालक श्री. विमल अगरवाल, श्री. गिरीष अगरवाल, स्वप्नील चव्हाण, अतुल पांडे व राजेश अगरवाल यांच्याशी संपर्क साधण्याचा वारंवार प्रयत्न केला परंतु त्यांनी कोणताही प्रतिसाद दिलेला नाही. उलटपक्षी दिनांक ११/११/२०२२ रोजी श्री. विमल अगरवाल व श्री. गिरीष अगरवाल यांनी एन.सी. एल.टी (नॅशनल कंपनी लॉ ट्रिब्युनल), मुंबई यांच्याकडे खटला दाखल करून सदर खटल्यामध्ये दिनांक ०१/०४/२०१९ पासून सुप्रिम ट्रान्सपोर्ट कंपनीने त्यांना कोणत्याही प्रकारचे मानधन दिले नाही असा दावा केला आहे.

(१) विमल अगरवाल (२) नुपर अगरवाल (३) गिरीष अगरवाल (४) समीक्षा अगरवाल (५) पिंकी अगरवाल (६) स्वप्नील चव्हाण (७) स्नेहा चव्हाण (८) अतुल पांडे व (९) रजनी पांडे, (१०) राजेश भगवानदास अगरवाल तसेच इतर काही व्यक्तींनी आणखीन काही रकमेचा अपहार केला असण्याची शक्यता असून त्या अनुषंगाने कंपनीतील आर्थिक व्यवहाराची बारकाईने छाननी/पडताळणी करण्यात येत आहे. पडताळणी दरम्यान नमुद व्यक्तींनी आणखीन काही रकमेचा अपहार केल्याचे निदर्शनास येताच तात्काळ सहार पोलीस ठाणेस कळविण्यात येईल.

तरी सुप्रिम ट्रान्सपोर्ट प्रा लि या कंपनीचे संचालक (१) श्री. विमल अगरवाल व (२) गिरीष अगरवाल आणि सी.एफ.ओ (३) कमलेश भैरव तातावत यांनी एप्रिल-२०१८ ते जुलै-२०२२ या कालावधीत आपसात संगणमत करून त्यांच्या वैयक्तिक आर्थिक फायद्या करीता भाडे आणि वेतनाच्या नावाखाली सुप्रिम ट्रान्सपोर्ट, संगीता एव्हीएशन सर्विस व माझ्या वैयक्तिक बँक खात्यातून खात्यातून एकुण ६,२७,३६,१८०/- रुपये एवढी रक्कम (१) विमल अगरवाल (२) नुपर अगरवाल (३) गिरीष अगरवाल (४) समीक्षा अगरवाल (५) पिंकी अगरवाल (६) स्वप्नील चव्हाण (७) स्नेहा चव्हाण (८) अतुल पांडे व (९) रजनी पांडे, (१०) राजेश भगवानदास अगरवाल यांच्या बँक खात्यामध्ये ट्रान्सफर करून एकुण ६,२७,३६,१८०/- एवढ्या रकमेचा अपहार करून फसवणुक केली आहे, म्हणून माझी त्यांचे विरुद्ध तक्रार असून कायदेशिर कारवाई होण्यास विनंती आहे.

माझा जबाब संगणकावर मराठीमध्ये टंकलेखित केला आहे, माझा जबाब मराठीमध्ये वाचून तो मला हिंदीमध्ये समजाऊन सांगितला असून माझे सांगणे प्रमाणे बरोबर आहे.

समक्ष

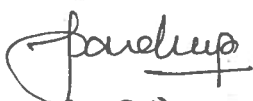

(सदीप शिंदे)

सहाय्यक पो. निरीक्षक  
सहार पोलीस ठाणे, मुंबई

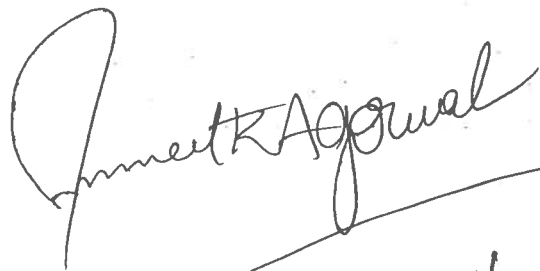

स.पो.अंतर्गत व.पो.नि. पो.नि.गुन्हे

2 APR 2023 2 6 APR 2023 2 6 APR 2023

पुरवणी जबाब

दिनांक ०३/०७/२०२३

श्री. अमीत कमल अगरवाल, वय ३४ वर्षे, धंदा—व्यवसाय, रा.ठी. ९०१ बिकानेर भवन, जे.बी. नगर, अंधेरी (पुर्व), मुंबई (मोबा—९८७०८११२२४)

मी, वरील प्रमाणे असुन वर नमुद पत्त्यावर रहावयास आहे. माझे फिर्यादीवरुन सहार पोलीस ठाणे, मुंबई येथे दिनांक २५/०४/२०२३ रोजी गु.र.क्र १५५/२०२३ कलम १२०(ब),४०८,४०९,४७७(अ),४२०,३४ भादवि अन्वये गुन्हा नोंदविण्यात आला आहे.

आज रोजी सहार पोलीस ठाणेचे सपोनि संदीप शिंदे यांनी मला सहार पोलीस ठाणे येथे बोलावुन उपरोक्त गुन्हायातील अटक आरोपी स्वप्नील बबन चव्हाण याने पोलीसांना सादर केलेले दिनांक १७/०७/२०२३ रोजी (1) Intimation Letter to Axis Bank (2) TDS Certificate 2017-18, (3) TDS Certificate 2018-19 (4) TDS Certificate 2019-20 & (5) TDS Certificate 2020-21 इत्यादी कागदपत्रे दाखवुन सदर कागदपत्रा बाबत माझ्याकडे विचारणा केली असता मी खालील प्रमाणे माहीती देत आहे.

संगीता एव्हीएशन प्रा लि या कंपनीमध्ये अधिकृत स्वाक्षरीकर्ता केवळ मी आहे. त्यामुळे स्वप्नील चव्हाण याने सादर केलेल्या Intimation Letter to Axis Bank वर असलेली अधिकृत स्वाक्षरी ही माझी नाही. तसेच संगीता एव्हीएशन प्रा. लि या कंपनीकडुन अॅक्सीस बँकेला अशा प्रकारचे कोणतेही पत्र देण्यात आलेले नाही.

तसेच आरोपी स्वप्नील चव्हाण याने पोलीसांना सादर केलेल्या टी.डी.एस. प्रमाणपत्राबाबत मी असे सांगतो की, वित्तीय वर्षे २०१७ ते २०२१ या कालावधीत संगीता एव्हीएशन प्रा लि या कंपनीच्या खात्यामधुन आरोपी स्वप्नील चव्हाण याने सांगितल्या प्रमाणे टी.डी.एस ची कोणतीही रक्कम कपात झालेली नाही. त्याबाबत मी संगीता एव्हीएशन प्रा लि कंपनीचे सर्व बुक्स ऑफ अकाऊंटस् तपासुन माहीती दत आहे. तसेच मी माझ्या कंपनीचे चार्टर्ड अकाऊंटंट श्री. गिरीष मुंदडा यांचेकडुन माहीती घेतली असता त्यांनी देखील अशा प्रकारची कोणतीही टी.डी.एस. ची रक्कम संगीता एव्हीएशन कंपनीकडुन तत्कालीन वित्तीय वर्षात कपात झाल्याच्या नोंदी मिळुन आल्या नाहीत असा अहवाल दिला आहे. त्याची एक प्रत त्यांनी परस्पर सहार पोलीस ठाणेस सादर केली आहे.

माझा जबाब संगणकावर मराठीमध्ये टंकलेखित केला आहे, माझा जबाब मराठीमध्ये वाचुन तो मला हिंदीमध्ये समजाऊन सांगितला असुन माझे सांगणे प्रमाणे बरोबर आहे.

समक्ष

  
(संदीप शिंदे)

सहाय्यक पो. निरीक्षक  
सहार पोलीस ठाणे, मुंबई



सहार पोलीस ठाणे, मुंबई.  
Sahar Police Station, Mumbai.

Near Indian Oil Depot. Opp. Hotel ITC Grand Maratha,  
Sahar Road, Andheri (E), Mumbai-400099.  
Phone No.: 022-26829783, 26817485, Fax No. 022-26829784,  
E-mail: ps.sahar.mum@mahapolice.gov.in.

O.W. No. 2615/2023

Date:- 27/04/2023

प्रति,

मा. महानगर दंडाधिकारी  
६३ वे न्यायालय, अंधेरी, मुंबई

विषय :- सहार पोलीस ठाणे, गु.र.क्र १५५/२०२३ कलम १२०(ब), ४०८,  
४०९, ४७७(अ), ४२०, ३४ भादवि हा गुन्हा ऑनलाईन नोंदवताना  
सिस्टममध्ये नजरचुकीने इतर मजकुर पेस्ट झाला असल्याबाबत.

महोदया,

सहार पोलीस ठाणे, मुंबई येथे दिनांक २५/०४/२०२३ रोजी गु.र.क्र  
१५५/२०२३ कलम १२०(ब), ४०९, ४०९, ४७७(अ), ४२०, ३४ भादवि अन्वये गुन्हा नोंद  
करण्यात आला आहे.

उपरोक्त गुन्ह्याचा CCTNS शासकीय प्रणालीवर ऑनलाईन प्रथम खबरी  
अहवाल नोंदवताना सदर गुन्ह्याच्या प्रथम खबरी अहवालातील पान क्रमांक ०८ ते १३  
वरील संपूर्ण मजकुर नजरचुकीने नोंद झाला (Pest झाला) आहे. तरी नजरचुकीने नोंद  
झालेला पान क्रमांक ०८ ते १३ वरील मजकुर या गुन्ह्यातील मजकुर संबोधण्यात येऊ  
नये. तो मजकुर या गुन्ह्याच्या प्रथम खबरी अहवालातुन वगळण्यात आला आहे अशी  
न्यायालयाच्या अभिलेखावर नोंद ठेवावी ही विनंती आहे.

तरी उपरोक्त अहवाल आपले माहीती व अवलोकनार्थ सविनय सादर  
करण्यात येत आहे.

0  
seen

me

29/04/23



आपला विश्वासु

*Sandeep*

(सदीप शिंदे)

सहाय्यक पो. निरीक्षक  
सहार पोलीस ठाणे, मुंबई

True Copy

Judicial Officer

Metropolitan Magistrate's  
53 rd Court, Andheri, Mumbai

de



सहार पोलीस ठाणे, मुंबई.

Sahar Police Station, Mumbai.

Near Indian Oil Depot. Opp. Hotel ITC Grand Maratha,  
Sahar Road, Andheri (E), Mumbai-400099.

Phone No.: 022-26829783, 26817485, Fax No. 022-26829784,

E-mail: ps.sahar.mum@mahapolice.gov.in.

O.W. No. 2596/2023

Date:- 27/04/2023

प्रति,

मा. महानगर दंडाधिकारी  
६३ वे न्यायालय, अंधेरी, मुंबई

विषय :- सहार पोलीस ठाणे, गु.र.क्र १५५/२०२३ कलम १२०(ब), ४०८,  
४०९,४७७(अ),४२०,३४ भादवि मधील आरोपीतांची बँक खाती  
गोठविल्याबाबत.

महोदय,

सहार पोलीस ठाणे, मुंबई येथे दिनांक २५/०४/२०२३ रोजी गु.र.क्र  
१५५/२०२३ कलम १२०(ब),४०९,४०९,४७७(अ),४२०,३४ भादवि अन्वये गुन्हा नोंद  
करण्यात आला आहे.

सदर गुन्हातील आरोपींनी आपहार/फसवणुकच्या रकमेचा लाभ घेण्या  
करीता खालील नमुद बँक खात्याचा वापर केला असल्याचे तपासामध्ये स्पष्ट झालेले  
आहे. सदर बँक खात्याचा तपशील खालील प्रमाणे आहे.

Sr. No	Bank Name	Account Numbers	Account holder Names
01	HDFC	02721000019875	Vimal Agarwal
02	HDFC	02721000018984	Nupur Agarwal
03	HDFC	02721000019892	Girish Agarwal
04	HDFC	02721000070214	Samixa Agarwal
05	HDFC	02721000055437	Pinky Agarwal
06	ICICI	104401531869	Swapnil Chavan
07	Axis	921010008877100	Swapnil Baban Chavan
08	Saraswat	013200128873557	Sneha Baban Chavan
09	HDFC	12111140000459	Atul Pandey
10	PNB	1565000100131966,	Rajni Surendra Pandey
11	ICICI	623501540474	Rajesh Agarwal

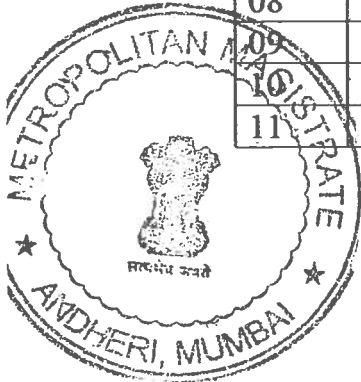

0  
seen  
OML  
29/04/23

कृपया मागे पहा.....

True Copy  
Metropolitan Magistrate  
53 rd Court, Andheri, Mumbai

Metropolitan Magistrate's  
53 rd Court, Andheri, Mumbai

उपरोक्त बँक खाती कलम १०२ फौदप्रस अन्वये गोठविण्या करीता HDFC Bank, Axis Bank, ICICI Bank, PNB & Saraswat Bank यांना ऑर्डर नोटीस पाठविण्यात आली आहे. त्यापैकी अॅक्सीस बँक व सारस्वत बँक यांना प्रत्यक्ष नोटीस देण्यात आली आहे, तर HDFC Bank, ICICI Bank, PNB यांना ईमेलद्वारे नोटीस पाठविण्यात आली आहे. आरोपींची बँक खाती गोठविण्यात आल्या बाबतची माहिती आरोपींना रजिस्टर्ड पोष्टाने कळविण्यात आली आहे. आरोपींची बँक खाती गोठविण्या करीता बँकेला पाठविलेल्या नोटीसच्या प्रती सोबत जोडल्या आहेत.

तरी उपरोक्त अहवाल आपले माहिती व अवलोकनार्थ सविनय सादर करण्यात येत आहे.



आपला विश्वासु

*Sandeep*

(सदीप शिंदे)

सहाय्यक पो. निरीक्षक  
सहार पोलीस ठाणे, मुंबई



सहार पोलीस ठाणे, मुंबई.

Sahar Police Station, Mumbai.

Near Indian Oil Depot. Opp. Hotel ITC Grand Maratha,  
Sahar Road, Andheri (E), Mumbai-400099.

Phone No.: 022-26829783, 26817485, Fax No. 022-26829784,

E-mail: [ps.sahar.mum@mahapolice.gov.in](mailto:ps.sahar.mum@mahapolice.gov.in).

O.W. No. 2586/2023

Date:- 27/04/2023

प्रति,

मा. महानगर दंडाधिकारी  
६३ वे न्यायालय, अंधेरी, मुंबई

विषय :- सहार पोलीस ठाणे, गु.र.क्र १५५/२०२३ कलम १२०(ब), ४०८,  
४०९, ४७७(अ), ४२०, ३४ भादवि मधील आरोपींतांची बँक खाती  
गोठविल्याबाबत.

महोदय,

सहार पोलीस ठाणे, मुंबई येथे दिनांक २५/०४/२०२३ रोजी गु.र.क्र  
१५५/२०२३ कलम १२०(ब), ४०९, ४०९, ४७७(अ), ४२०, ३४ भादवि अन्वये गुन्हा नोंद  
करण्यात आला आहे.

सदर गुन्हातील आरोपींनी आपहार/फसवणुकच्या रकमेचा लाभ घेण्या  
करीता खालील नमुद बँक खात्याचा वापर केला असल्याचे तपासामध्ये स्पष्ट झालेले  
आहे. सदर बँक खात्याचा तपशील खालील प्रमाणे आहे.

Sr. No	Bank Name	Account Numbers	Account holder Names
01	HDFC	02721000019875	Vimal Agarwal
02	HDFC	02721000018984	Nupur Agarwal
03	HDFC	02721000019892	Girish Agarwal
04	HDFC	02721000070214	Samixa Agarwal
05	HDFC	02721000055437	Pinky Agarwal
06	ICICI	104401531869	Swapnil Chavan
07	Axis	921010008877100	Swapnil Baban Chavan
08	Saraswat	013200128873557	Sneha Baban Chavan
09	HDFC	12111140000459	Atul Pandey
10	PNB	1565000100131966,	Rajni Surendra Pandey
11	ICICI	623501540474	Rajesh Agarwal

कृपया मागे पहा.....

उपरोक्त बँक खाती कलम १०२ फौदप्रस अन्वये गोठविण्या करीता HDFC Bank, Axis Bank, ICICI Bank, PNB & Saraswat Bank यांना ऑर्डर नोटीस पाठविण्यात आली आहे. त्यापैकी अॅक्सी बँक व सारस्वत बँक यांना प्रत्यक्ष नोटीस देण्यात आली आहे, तर HDFC Bank, ICICI Bank, PNB यांना ईमेलद्वारे नोटीस पाठविण्यात आली आहे. आरोपींची बँक खाती गोठविण्यात आल्या बाबतची माहिती आरोपींना रजिस्टर्ड पोष्टाने कळविण्यात आली आहे. आरोपींची बँक खाती गोठविण्या करीता बँकेला पाठविलेल्या नोटीसच्या प्रती सोबत जोडल्या आहेत.

तरी उपरोक्त अहवाल आपले माहिती व अवलोकनार्थ सविनय सादर करण्यात येत आहे.



आपला विश्वासु

*Sandeep*

(संदीप शिंदे)

सहाय्यक पो. निरीक्षक  
सहार पोलीस ठाणे, मुंबई



सहार पोलीस ठाणे, मुंबई.  
Sahar Police Station, Mumbai.

Near Indian Oil Depot. Opp. Hotel ITC Grand Maratha,  
Sahar Road, Andheri (E), Mumbai-400099.  
Phone No.: 022-26829783, 26817485, Fax No. 022-26829784,  
E-mail: ps.sahar.mum@mahapolice.gov.in.

O.W. No. 2550/2023

Date: - 26/04/2023

**ORDER UNDER SEC. 102 & 91 OF CRIMINAL PROCEDURE CODE, 1973**

To,  
The Manager,  
Axis Bank Limited  
Mumbai

**Sub.: Order to Debit freeze the account and produce documents under section 102 & 91 CrPC.**

**Ref: Sahar Police Station, Mumbai, FIR No 155/2023**

**Under Section 120(b), 408, 409, 477(a), 420, 34 of IPC.**

WHEREAS, the above mentioned case is presently being investigated by the undersigned and,

WHEREAS it is reported during the investigation of the case that various accounts were opened by the accused persons with your bank, details of which are as under.

Sr. No	A/C No.	A/C Name
01	921010008877100	Swapnil Baban Chavan

WHEREAS, during course of investigation it is disclosed that the above accounts were used by the accused persons for the purpose of siphoning off the proceeds of crime.

WHEREAS there is possibility of that the proceeds of crime is still deposited in the above accounts and therefore it is necessary that these accounts must be put under DEBIT FREEZE

NO LOCKER  
NO FDR  
IN A/C UNF

STATEMENT  
AAM  
ACCOUNT OPENING  
FORM  
PROVIDED  
AS 26/4/2023



AS ON  
26/4/2023  
13:42  
PM

WHEREAS, the following documents are required for the purpose of investigation of this case, you are hereby directed to produce or cause to be produced the following documents before the undersigned on 04.05.2023 at 11.00hrs at this office **without fail**.

1. Account Opening Forms, Specimen Signature Cards and updated Statements of Accounts from the date of opening till date of all bank accounts in the name of Swapnil Baban Chavan and his family members namely

2. Details of all Bank Lockers/FDR held by the above said persons in Bank

3. All cheques, vouchers, instructions given by the above mentioned account holders regarding deposits/withdrawals/transfers of funds from/to the above said accounts of the above said persons.

4. Any other document found to be relevant with the bank accounts of the above said persons in Bank

In view of the above you are therefore directed to debit freeze the aforesaid accounts instantly on receipt of this notice and inform this office immediately.

In case of any clarification, you may contact the undersigned over mobile No.9870285010.

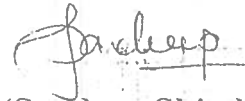

(Sandeep Shinde)

Asst. Police Inspector &  
Investigation Officer,  
Sahar Police Station, Mumbai.

Copy submitted to

1) The Metropolitan Magistrate, court room No 63, Andheri Court, Mumbai.

Copy to

1) Mr. Swapnil Baban Chavan





सहार पोलीस ठाणे, मुंबई.  
Sahar Police Station, Mumbai.

Near Indian Oil Depot. Opp. Hotel ITC Grand Maratha,  
Sahar Road, Andheri (E), Mumbai-400099.  
Phone No.: 022-26829783, 26817485, Fax No. 022-26829784,  
E-mail: ps.sahar.mum@mahapolice.gov.in.

O.W. No. 2848/2023

Date: - 26/04/2023

ORDER UNDER SEC. 102 & 91 OF CRIMINAL PROCEDURE CODE, 1973

To,  
The Manager,  
Saraswat Bank Limited  
Mumbai

**Sub.: Order to Debit freeze the account and produce documents  
under section 102 & 91 CrPC.**

**Ref: Sahar Police Station, Mumbai, FIR No 155/2023  
Under Section 120(b), 408, 409, 477(a), 420, 34 of IPC.**

WHEREAS, the above mentioned case is presently being investigated by the undersigned and,

WHEREAS it is reported during the investigation of the case that various accounts were opened by the accused persons with your bank, details of which are as under.

Sr. No	A/C No.	A/C Name
01	013200128873557	Sneha Baban Chavan

WHEREAS during course of investigation it is disclosed that the above accounts were used by the accused persons for the purpose of siphoning off the proceeds of crime.

WHEREAS there is possibility of that the proceeds of crime is still deposited in the above accounts and therefore it is necessary that these accounts must be put under DEBIT FREEZE



Recd. by  
26.4.23  
13.03 PM  
Jmms

WHEREAS, the following documents are required for the purpose of investigation of this case, you are hereby directed to produce or cause to be produced the following documents before the undersigned on 04.05.2023 at 11.00hrs at this office **without fail**.

1. Account Opening Forms, Specimen Signature Cards and updated Statements of Accounts from the date of opening till date of all bank accounts in the name of Sneha Baban Chavan and her family members namely
2. Details of all Bank Lockers/FDR held by the above said persons in Bank.
3. All cheques, vouchers, instructions given by the above mentioned account holders regarding deposits/withdrawals/transfers of funds from/to the above said accounts of the above said persons.
4. Any other document found to be relevant with the bank accounts of the above said persons in Bank

In view of the above you are therefore directed to debit freeze the aforesaid accounts instantly on receipt of this notice and inform this office immediately.

In case of any clarification, you may contact the undersigned over mobile No.9870285010.

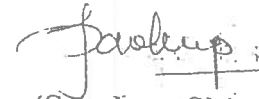

(Sandeep Shinde)

Asst. Police Inspector &  
Investigation Officer,  
Sahar Police Station, Mumbai.

Copy submitted to

- 1) The Metropolitan Magistrate, court room No 63, Andheri Court, Mumbai.

Copy to

- 1) Mrs. Sneha Baban Chavan





सहार पोलीस ठाणे, मुंबई.

Sahar Police Station, Mumbai.

Near Indian Oil Depot. Opp. Hotel ITC Grand Maratha,  
Sahar Road, Andheri (E), Mumbai-400099.

Phone No.: 022-26829783, 26817485, Fax No. 022-26829784,

E-mail: [ps.sahar.mum@mahapolice.gov.in](mailto:ps.sahar.mum@mahapolice.gov.in).

O.W. No. 2546 / 2023

Date: - 26/04/2023

**ORDER UNDER SEC. 102 & 91 OF CRIMINAL PROCEDURE CODE, 1973**

To,

The Manager,  
HDFC Bank Limited  
Mumbai

**Sub.: Order to Debit freeze the account and produce documents  
under section 102 & 91 CrPC.**

**Ref: Sahar Police Station, Mumbai, FIR No 155/2023  
Under Section 120(b), 408, 409, 477(a), 420, 34 of IPC.**

WHEREAS, the above mentioned case is presently being investigated by the undersigned and,

WHEREAS it is reported during the investigation of the case that various accounts were opened by the accused persons with your bank, details of which are as under.

Sr. No	A/C No.	A/C Name
01	02721000019875	Vimal Agarwal
02	02721000018984	Nupur Agarwal
03	02721000019892	Girish Agarwal
04	02721000070214	Samixa Agarwal
05	02721000055437	Pinky Agarwal
06	12111140000459	Atul Pandey

WHEREAS during course of investigation it is disclosed that the above accounts were used by the accused persons for the purpose of siphoning off the proceeds of crime.

WHEREAS there is possibility of that the proceeds of crime is still deposited in the above accounts and therefore it is necessary that these accounts must be put under DEBIT FREEZE

WHEREAS, the following documents are required for the purpose of investigation of this case, you are hereby directed to produce or cause to be produced the following documents before the undersigned on 04.05.2023 at 11.00hrs at this office without fail.

1. Account Opening Forms, Specimen Signature Cards and updated Statements of Accounts from the date of opening till date of all bank accounts in the name of Vimal Agarwal, Nupur Agarwal, Girish Agarwal, Samixa Agarwal, Pinky Agarwal & Atul Pandey and their family members namely
2. Details of all Bank Lockers/FDR held by the above said persons in Bank.
3. All cheques, vouchers, instructions given by the above mentioned account holders regarding deposits/withdrawals/transfers of funds from/to the above said accounts of the above said persons.
4. Any other document found to be relevant with the bank accounts of the above said persons in Bank.

In view of the above you are therefore directed to debit freeze the aforesaid accounts instantly on receipt of this notice and inform this office immediately.

In case of any clarification, you may contact the undersigned over mobile No.9870285010.

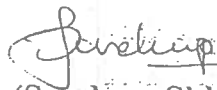

  
(Sandeep Shinde)  
Asst. Police Inspector &  
Investigation Officer,  
Sahar Police Station, Mumbai.

Copy submitted to

- Copy to
- 1) The Metropolitan Magistrate, court room No 63, Andheri Court, Mumbai.
- Mr. Vimal Agarwal, Mrs. Nupur Agarwal, Mr. Girish Agarwal, Mrs. Samixa Agarwal, Smt. Pinky Agarwal, & Mr. Atul Pandey

Email

SAHAR POLICE STATION

---

**Order to debit freeze of HDFC Accounts**

---

**From :** SAHAR POLICE STATION  
<ps.sahar.mum@mahapolice.gov.in>

Wed, Apr 26, 2023 03:37 PM

**Subject :** Order to debit freeze of HDFC Accounts

📎 1 attachment

**To :** lea communication <lea.communication@hdfcbank.com>

Please see our letter attached herewith

Regards  
(Sandeep Shinde)  
Asst. Police Inspector  
Sahar Police Station, Mumbai

---

📎 **Letter for Debit Freet.pdf**  
826 KB

---



सहार पोलीस ठाणे, मुंबई.

Sahar Police Station, Mumbai.

Near Indian Oil Depot. Opp. Hotel ITC Grand Maratha,  
Sahar Road, Andheri (E), Mumbai-400099.

Phone No.: 022-26829783, 26817485, Fax No. 022-26829784,  
E-mail: [ps.sahar.mum@mahapolice.gov.in](mailto:ps.sahar.mum@mahapolice.gov.in).

O.W. No. 2547/2023

Date: - 26/04/2023

**ORDER UNDER SEC. 102 & 91 OF CRIMINAL PROCEDURE CODE, 1973**

To,

The Manager,  
ICICI Bank Limited  
Mumbai

**Sub.: Order to Debit freeze the account and produce documents  
under section 102 & 91 CrPC.**

**Ref: Sahar Police Station, Mumbai, FIR No 155/2023  
Under Section 120(b), 408, 409, 477(a), 420, 34 of IPC.**

WHEREAS, the above mentioned case is presently being investigated by the undersigned and,

WHEREAS it is reported during the investigation of the case that various accounts were opened by the accused persons with your bank, details of which are as under.

Sr. No	A/C No.	A/C Name
01	104401531869	Swapnil Chavan
02	623501540474	Rajesh Agarwal

WHEREAS during course of investigation it is disclosed that the above accounts were used by the accused persons for the purpose of siphoning off the proceeds of crime.

WHEREAS there is possibility of that the proceeds of crime is still deposited in the above accounts and therefore it is necessary that these accounts must be put under DEBIT FREEZE

WHEREAS, the following documents are required for the purpose of investigation of this case, you are hereby directed to produce or cause to be produced the following documents before the undersigned on 04.05.2023 at 11.00hrs at this office **without fail**.

1. Account Opening Forms, Specimen Signature Cards and updated Statements of Accounts from the date of opening till date of all bank accounts in the name of Swapnil Chavan & Rajesh Agarwal and their family members namely

2. Details of all Bank Lockers/FDR held by the above said persons in Bank.

3. All cheques, vouchers, instructions given by the above mentioned account holders regarding deposits/withdrawals/transfers of funds from/to the above said accounts of the above said persons.

4. Any other document found to be relevant with the bank accounts of the above said persons in Bank

In view of the above you are therefore directed to debit freeze the aforesaid accounts instantly on receipt of this notice and inform this office immediately.

In case of any clarification, you may contact the undersigned over mobile No.9870285010.

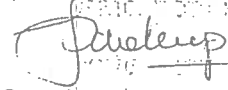

(Sandeep Shinde)  
Asst. Police Inspector &  
Investigation Officer,  
Sahar Police Station, Mumbai.

Copy submitted to

1) The Metropolitan Magistrate, court room No 63, Andheri Court, Mumbai.

Copy to

- 1) Mr. Swapnil Chavan
- 2) Mr. Rajesh Agarwal

26 APR 2023  
RECEIVED



Priti Naik

8879658795

priti.naik@icicibank.com

Email

SAHAR POLICE STATION

---

**Order to Debit Freeze of ICICI Account**

---

**From :** SAHAR POLICE STATION  
<ps.sahar.mum@mahapolice.gov.in>

Wed, Apr 26, 2023 03:43 PM

 1 attachment

**Subject :** Order to Debit Freeze of ICICI Account

**To :** priti naik <priti.naik@icicibank.com>

Pleas our letter attached herewith

Regards  
(Sandeep Shinde)  
Asst. Police Inspector  
Sahar Police Station, Mumbai

---

 **Letter for Debit Freeze of ICICI Account.pdf**  
808 KB

---



सहार पोलीस ठाणे, मुंबई.

Sahar Police Station, Mumbai.

Near Indian Oil Depot. Opp. Hotel ITC Grand Maratha,  
Sahar Road, Andheri (E), Mumbai-400099.

Phone No.: 022-26829783, 26817485, Fax No. 022-26829784,  
E-mail: [ps.sahar.mum@mahapolice.gov.in](mailto:ps.sahar.mum@mahapolice.gov.in).

O.W. No. 2549/2023

Date: -26/04/2023

**ORDER UNDER SEC. 102 & 91 OF CRIMINAL PROCEDURE CODE, 1973**

To,  
The Manager,  
Punjab National Bank  
Mumbai

Sub.: Order to Debit freeze the account and produce documents  
under section 102 & 91 CrPC.

Ref: Sahar Police Station, Mumbai, FIR No 155/2023  
Under Section 120(b), 408,409,477(a),420, 34 of IPC.

WHEREAS, the above mentioned case is presently being investigated by the undersigned and,

WHEREAS it is reported during the investigation of the case that various accounts were opened by the accused persons with your bank, details of which are as under.

Sr. No	A/C No.	A/C Name
01	1565000100131966,	Rajni Surendra Pandey

WHEREAS during course of investigation it is disclosed that the above accounts were used by the accused persons for the purpose of siphoning off the proceeds of crime.

WHEREAS there is possibility of that the proceeds of crime is still deposited in the above accounts and therefore it is necessary that these accounts must be put under DEBIT FREEZE

WHEREAS, the following documents are required for the purpose of investigation of this case, you are hereby directed to produce or cause to be produced the following documents before the undersigned on 04.05.2023 at 11.00hrs at this office without fail.

1. Account Opening Forms, Specimen Signature Cards and updated Statements of Accounts from the date of opening till date of all bank accounts in the name of Sneha Baban Chavan and her family members namely

2. Details of all Bank Lockers/FDR held by the above said persons in Bank .

3. All cheques, vouchers, instructions given by the above mentioned account holders regarding deposits/withdrawals/transfers of funds from/to the above said accounts of the above said persons.

4. Any other document found to be relevant with the bank accounts of the above said persons in Bank

In view of the above you are therefore directed to debit freeze the aforesaid accounts instantly on receipt of this notice and inform this office immediately.

In case of any clarification, you may contact the undersigned over mobile No.9870285010.

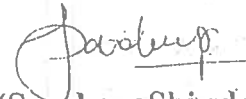

(Sandeep Shinde)

Asst. Police Inspector &  
Investigation Officer,  
Sahar Police Station, Mumbai.

Copy submitted to

1) The Metropolitan Magistrate, court room No 63, Andheri Court, Mumbai.

Copy to

1) Mrs.Sneha Baban Chavan



**Email**

---

**Order to Debit Freeze of PNB Account**

---

**From :** SAHAR POLICE STATION  
<ps.sahar.mum@mahapolice.gov.in>  
**Subject :** Order to Debit Freeze of PNB Account  
**To :** bo1565@pnb.co.in

Wed, Apr 26, 2023 03:46 PM  
📎 1 attachment

Pleas our letter attached herewith

Regards  
(Sandeep Shinde)  
Asst. Police Inspector  
Sahar Police Station, Mumbai

---

📎 **Letter for Debit Freeze of PNB Account.pdf**  
747 KB

---

जबाब

दिनांक १६/०३/२०२३

श्री. गिरीष गोपालदास मुंदडा, वय ३५ वर्षे, धंदा—चार्टड अकाऊंटंट, रा.ठी. फ्लॉट नंबर—१, ब्रिज अपार्टमेंट, फ्लॉट नंबर—६३, प्रोजन मॉल, सिडको एन—१, छत्रपती संभाजी नगर, महाराष्ट्र—४३१००३ (मोबा—९४२२९२५४२२)

मी, वरील प्रमाणे असुन वर नमुद पत्त्यावर रहावयास आहे. मी व्यवसायाने चार्टड अकाऊंटंट आहे. मी व चार्टड अकाऊंटंट श्री. संतोष लोया असे दोघो भागीदारी मध्ये चार्टड अकाऊंटंटचे काम करीत असुन आमच्या फर्मचे नाव “ लोया अॅन्ड मुंदडा ” असे आहे. तर फर्मचा पत्ता—३१५ साई ट्रेड सेंटर, ३रा माळा, आर.टी.ओ. रोड, रेल्वे स्टेशन जवळ, छत्रपती संभाजी नगर, महाराष्ट्र असा आहे. माझा इस्टीटयुट ऑफ चार्टड अकाऊंटंट ऑफ इंडिया यांच्याकडुन मिळालेला मेंबरशिप क्रमांक 141172 असा आहे.

सन—२०२१ मध्ये सुप्रिम ट्रान्सपोर्ट ऑर्गनायझेशन प्रा लि, आणि संगीता एव्हीशन सर्वीसेस प्रा लि कंपनीने चार्टड अकाऊंटंट म्हणुन आमच्या फर्मची नियुक्ती केली आहे. सदर कंपनीचे सन—२०२०—२१ व २०२१—२२ दोन आर्थीक वर्षातील दोन्ही कंपनीच्या आर्थीक व्यवहाराची तपासणी/छाननी करण्याचे काम आमच्या फर्मला दिलेले आहे.

त्या प्रमाणे आमच्या फर्मकडुन सुप्रिम ट्रान्सपोर्ट ऑर्गनायझेशन प्रा लि, या कंपनीचे सन—२०२०—२१ आणि सन—२०२१—२२ या दोन वर्षातील आर्थीक व्यवहाराची तपासणी/छाननी केली होती. तर संगीता एव्हीशन सर्वीसेस प्रा लि या कंपनीच्या फक्त सन—२०२०—२१ या वर्षातील आर्थीक व्यवहाराची तपासणी करण्यात आली होती. परंतु एन.सी.एल.टी यांनी ऑगस्ट—२०२१ मध्ये सदर कंपनीची दिवाळखोर कंपनी अशी घोषणा करुन त्यावर प्रशासक नेमला असल्यामुळे सन—२०२१—२२ या वर्षातील संगीता एव्हीशन कंपनीच्या आर्थीक व्यवहाराची तपासणी/छाननी करण्यात आली नाही.

सन—२०२०—२१ आणि सन—२०२१—२२ या आर्थीक वर्षातील कंपनीच्या आर्थीक व्यवहाराची तपासणी करताना वेतन, भाडे, कन्सलटन्सी फिस याबाबत पुरक कागदपत्रे (म्हणजेच नियुक्तीपत्र, रेंट अॅग्रीमेंट, कन्सलटन्सी परचेस ऑर्डर व बिल इत्यादी) मिळुन आले नाहीत, त्याबाबत आम्ही कंपनीच्या अकाऊन्ट्स विभागाकडे त्या कागदपत्राची मागणी केली होती, परंतु कंपनीच्या अकाऊन्ट्स विभागाने सदर कागदपत्राची पुर्तता झालेली नव्हती. याबाबत आम्ही संबंधीत व्यवहाराच्या कागदापत्रावर तसे शोरे मारलेले आहेत. तसेच कंपनीला दिलेल्या Query Report मध्ये त्याबाबत स्पष्टपणे नमुद केलेले आहे. त्या रिपोर्टची कॉपी मी हजर करीत आहे.

दिनांक ०६/०९/२०२२ रोजी उपरोक्त कंपनीचे सी.ई.ओ श्री. अमीत आग्रवाल यांनी लेखी पत्र देऊन त्यांच्या दोन्ही कंपनीमध्ये आर्थीक गैरव्यवहार झाला असावा अशी त्यांना शंका वाटत असल्याचे सांगुन त्यांच्या दोन्ही कंपनीतील सन—२०१८—१९ ते सन—२०२१—२२ या वर्षातील आर्थीक व्यवहाराची पुन्हा तपासणी/छाननी करण्याची विनंती केली होती. त्या प्रमाणे आम्ही दोन्ही कंपनीच्या आर्थीक व्यवहाराची तपासणी केली आहे.

दोन्ही कंपनीच्या आर्थिक व्यवहाराच्या पुर्न: तपासणी/छाननी दरम्यान आमच्या असे निदर्शनास आले आहे की, आम्ही दोन्ही कंपनीच्या तपासणी केलेल्या आर्थिक वर्षा २०२०-२१ व २०२१-२२ यामध्ये आम्हाला निदर्शनास आलेले Unsupported Vouchers हे कंपनीच्या अकाऊंट्स विभागाने कंपनीच्या संचालक मंडळाकडून मंजुर करून घेतले नव्हते. तसेच कंपनीचे संचालक श्री. अमीत आग्रवाल यांच्या विनंती पत्रावरून आम्ही कंपनीचे सन-२०१८-१९ व २०१९-२० या आर्थिक वर्षाची तपासणी केली असता यामध्ये देखील त्याच प्रमाणे Unsupported Vouchers वेतन, भाडे, कन्सलटन्सी फिस इत्यादी खर्चाबद्दल मिळून आले. ते देखील कंपनीच्या संचालक मंडळाकडून मंजुर केले नसल्याचे आढळून आले. यावरून सुप्रीम कंपनीचे काही पदाधिकारी हे दोन्ही कंपनीच्या व्यवहारामध्ये अशा प्रकारे सतत पैशाचा अपहार करीत असल्याचे निदर्शनास आले. त्याबाबत आम्ही दिनांक ०२/०३/२०२३ रोजी श्री. अमीत आग्रवाल संचालक- सुप्रीम ट्रान्सपोर्ट ऑर्गनायझेशन सर्वीसेस प्रा लि व संगीता एव्हीएशन सर्वीसेस प्रा लि यांना सविस्तर अहवाल सादर केला आहे.

सदर तपासणी मध्ये आमच्या असे निदर्शनास आले आहे की, सुप्रीम ट्रान्सपोर्ट ऑर्गनायझेशन सर्वीसेस प्रा लि, संगीता एव्हीएशन सर्वीसेस प्रा लि या दोन्ही कंपनीच्या बँक खात्यातून तसेच अमीत आग्रवाल यांच्या वैयक्तिक बँक खात्यातून सुप्रीम ट्रान्सपोर्ट कंपनीचे पदाधिकारी व इतर काही लाभार्थी यांच्या वैयक्तिक बँक खात्यावर खालील प्रमाणे रक्कम ट्रान्सफर झाली असून ते पदाधिकारी व लाभार्थी यांची नावे खालील प्रमाणे आहेत.

Sr. No	Beneficiary Name	STOPL	SASPL	Ammeet Agarwal
01	Vimal Kumar Agarwal	2,20,64,958	13,93,250	8,00,000
02	Nupur Vimal Agarwal	31,50,381	8,17,600	8,00,000
03	Girish Kumar Agarwal	40,49,775	13,93,250	8,00,000
04	Samixa Girish Agarwal	20,56,256	10,95,500	8,00,000
05	Pinki Jagdish Agarwal	49,75,256	8,77,150	7,86,611
06	Rajesh Agarwal		88,65,778	
07	Balaji Enterprises		27,34,409	
08	Swapnil BabanChavan		45,52,400	
09	Sneha Baban Chavan		47,55,000	
10	Atul Surendra Pandey		37,34,000	
11	Rajani Surendra Pandey		11,00,000	
12	Noor Bank	30,00,000		
	Total	3,92,96,626/-	3,13,18,337/-	39,86,611/-

आम्ही केलेल्या तपासणी मध्ये सन-२०१८ ते सन-२०२२ या कालावधीत कंपनीचे पदाधिकारी श्री. विमल आग्रवाल व श्री. गिरीष आग्रवाल व इतर लाभार्थी यांनी एकुण रक्कम रुपये ०७,४६,०१,५७८/- एवढ्या रकमेचा गैरव्यवहार केला असून सदर रकमेचा अपहार झाला असल्याबाबतचा सविस्तर अहवाल आम्ही सादर केलेला आहे.



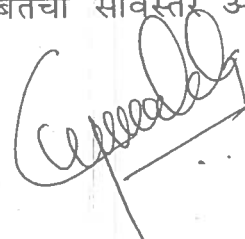

श्री. गिरीष गोपालदास मुंदडा, वय ३५ वर्षे यांचा जबाब पुढे चालू.....

माझा जबाब संगणकावर मराठीमध्ये टंकलेखित केला आहे, माझा जबाब मी वाचून पाहीला असुन तो माझे सांगणे प्रमाणे बरोबर आहे.

समक्ष

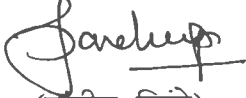

(संदीप शिंदे)

सहाय्यक पो. निरीक्षक  
सहार पोलीस ठाणे, मुंबई



# LOYA & MUNDADA

CHARTERED ACCOUNTANTS

March 2<sup>nd</sup> 2023

To,

**Shri Kamal Agarwal**  
Chairman  
**Supreme Transport Organisation Pvt Ltd**  
5B 34 Akshay Mittal Industrial Estate, MV Road  
Andheri East, Mumbai 400059

**H.E. Capt Ammeet K Agarwal**  
President & CEO  
**Sangeeta Aviation Services Pvt Ltd**  
5B 32 Akshay Mittal Industrial Estate, MV Road  
Andheri East, Mumbai 400059

**Captain Ammeet K Agarwal**  
901 Bikaner Bhawan, JB Nagar  
Andheri East, Mumbai 400059

**Subject: Scrutiny of fraud of Rs. 7.46+ Crores (Rs. 7,46,01,578/-)**

Dear Sirs,

1. We have been appointed to scrutinize independently, audit and submit report on afore mentioned subject that took place between 2018 till date. As per your letter dated 06/09/2022. We are hereby enclosing detailed, unbiased report for your perusal.
2. We came to know that the existing directors had filed a police complaint with Sahar Police has been filed, through the Economics Offence Wing (EOW) to further investigate this allegation followed by registering of F.I.R. and appropriate actions as per the law.

ADDRESS: - 315, 3rd Floor, Sai Trade Centre, Near Mayor Bungalow, Railway Station Road,  
Aurangabad Maharashtra, India

Contact. +919422925422 Email. mundadagirish@gmail.com



# LOYA & MUNDADA

CHARTERED ACCOUNTANTS

3. This report is prepared with the help of all account statements that were provided to us by the promoters. We are not responsible for any data or information, that would have not been covered, due to non-availability of bank statements.

4. Overview of amounts of transactions done:

Names of the Accused	Total in Rs.	STOPL	SASPL	AMMEET K
Vimal Kumar Jagdish Agrawal	2,42,58,208	2,20,64,958	13,93,250	8,00,000
Nupur Vimal Agrawal	47,67,981	31,50,381	8,17,600	8,00,000
Girish Kumar Jagdish Agrawal	62,43,029	40,49,775	13,93,250	8,00,000
Samixa Girish Agrawal	39,51,756	20,56,256	10,95,500	8,00,000
Pinki Jagdish Agrawal	66,39,017	49,75,256	8,77,150	7,86,611
Rajesh Bhagwandas Agrawal	88,65,778		88,65,778	
Balaji Enterprises R.B. Agrawal	27,34,409		27,34,409	
Swapnil Baban Chavan	45,52,400		45,52,400	
Sneha Baban Chavan	47,55,000		47,55,000	
Atul Surendra Pandey	37,34,000		37,34,000	
Rajini Surendra Pandey	11,00,000		11,00,000	
Dubai Hawala Noor Bank	30,00,000	30,00,000		
<b>Total Siphoning Off Rs.</b>	<b>7,46,01,578/-</b>	<b>3,92,96,626</b>	<b>3,13,18,337</b>	<b>39,86,611</b>

5. Accounts scrutinized of the victims:

Supreme Transport Organisation Pvt Ltd	HDFC	10452840000014
Supreme Transport Organisation Pvt Ltd	HDFC	03302840000157
Supreme Transport Organisation Pvt Ltd	HDFC	01662840000470
Supreme Transport Organisation Pvt Ltd	HDFC	03302840000140

ADDRESS: - 315, 3rd Floor, Sai Trade Centre, Near Mayor Bungalow, Railway Station Road,  
Aurangabad Maharashtra, India

Contact. +919422925422 Email. mundadagirish@gmail.com



# LOYA & MUNDADA

CHARTERED ACCOUNTANTS

Ltd		
Supreme Transport Organisation Pvt Ltd	HDFC	04072840000053
Supreme Transport Organisation Pvt Ltd	HDFC	00602340000085
Supreme Transport Organisation Pvt Ltd	P.N.B.	10451131002901
Supreme Transport Organisation Pvt Ltd	B.O.I.	843720110000498
Supreme Transport Organisation Pvt Ltd	B.O.I.	004420110000823
Sangeeta Aviation Services Pvt Ltd	DCB	004XXXXXX2745
Sangeeta Aviation Services Pvt Ltd	HDFC	50200008133578
Sangeeta Aviation Services Pvt Ltd	CITIBANK	0060246114
Captain Ammeet K Agarwal	DCB	00410200001403
Captain Ammeet K Agarwal	PNB	10452191004874

## 6. Accounts recommended for immediate freezing:

Vimal Kumar Jagdish Agrawal	HDFC	02721000019875
Nupur Vimal Kumar Jagdish Agrawal	HDFC	02721000018984
Girish Kumar Jagdish Agrawal	HDFC	02721000019892
Samixa Girish Kumar Agrawal	HDFC	02721000070214
Pinki Jagdish Agrawal	HDFC	02721000055437
Swapnil Chavan	ICICI Bank	104401531869
Swapnil Chavan	Axis Bank	921010008877100
Sneha Baban Chavan	Sarswat Bank	013200128873557
Atul Surendra Pandey	HDFC Bank	12111140000459
Rajini Surendra Pandey	PNB	1565000100131966
Balaji Enterprises	Bassein Catholic Coop Bank Ltd	012130300000051

ADDRESS: - 315, 3rd Floor, Sai Trade Centre, Near Mayor Bungalow, Railway Station Road,  
Aurangabad Maharashtra, India

Contact. +919422925422 Email. mundadagirish@gmail.com



# LOYA & MUNDADA

CHARTERED ACCOUNTANTS

7. ALL THE PERSONS MENTIONED ABOVE HAVE falsified ALL THE ACCOUNTS belonging to BOTH THE COMPANIES and PERSONAL ACCOUNT of CAPT AMMEET K AGARWAL.
8. Complete siphoning has been done through online transactions, which primarily have been conducted by Mr. Girish Jagdish Agrawal and Mr. Kamlesh Bairwa Tatawat.
9. All the chequebook leaflets have been scrutinized. None of the leaflets have entries of the siphoned off amounts.
10. The directors tried to log in by forget password option on behalf of company's HDFC accounts, registered email id is girish@stopt.in and his mobile number.
11. Multiple emails are available on record where Kamlesh is requesting the bank in last quarter of 2022 to update records from his email id and mobile number to owner's mobile number and email id.

\*\*\*\*\*
12. Prima facie as per the scrutiny & explanation we got, we are in opinion that the amount being unauthorisedly transfer or used has been detailed in annexures. Explanation for the transactions done to be taken from the concerned persons with documentary proof they have. Then only the allegation of Siphoned off money to be decided.
13. Mr. Vimal Agrawal has unauthorisedly transfer an amount of Rs. 2,42,58,208/- (Rs.2.42 Crores).
14. Annex 1 has details of all transactions of Rs. 2,42,58,208/- from afore mentioned accounts to Vimal's personal account.
15. Mrs. Nupur Agrawal has transactions of an amount of Rs. 47,67,981/- (Rs.47.67 Lakhs).

ADDRESS: - 315, 3rd Floor, Sai Trade Centre, Near Mayor Bungalow, Railway Station Road,  
Aurangabad Maharashtra, India

Contact. +919422925422 Email. mundadagirish@gmail.com



# LOYA & MUNDADA

CHARTERED ACCOUNTANTS

16. Annex 2 has details of all transactions of Rs. 47,67,981/- from afore mentioned accounts to Nupur's personal account.
17. Mr. Girish Agrawal has transactions of an amount of Rs. 62,43,029/- (Rs.62.43 Lakhs. Annex 3 has details of all the transactions of Rs. 62,43,029/- from afore mentioned accounts to Girish's personal account.
18. Mrs. Samixa Girish Agrawal has transactions of an amount of Rs. 39,51,756/- (Rs.39.51 Lakhs). Annex 4 has details of all the transactions of Rs. 39,51,756/-
19. Ms. Pinki Agrawal has transaction of an amount of Rs. 66,39,017/- (Rs.66.39 Lakhs). Annex 5 has details of all the transactions of Rs. 66,39,017/- from afore mentioned accounts to Pinki's personal account.
20. Mr. Rajesh Agrawal has transactions of total amount of Rs. 1,16,00,187/- from Sangeeta Aviation Services Pvt Ltd EXCLUSIVELY, out of which Rs. 27,34,409/- was unauthorisedly transfer to his proprietorship firm BALAJI ENTERPRISES and balance Rs. 88,65,778/- to his personal account.
21. Annex 6 has details of all funds transfer transactions of Rs. 1,16,00,187/- from afore mentioned accounts to Rajesh Agrawal's personal account and Balaji Enterprises account.
22. Mr. Swapnil Baban Chavan has transactions of a total amount of Rs. 1,23,07,400/-.
23. Out of this Rs. 1,23,07,400/- an amount of Rs. 45,52,400/- was unauthorisedly transfer to Swapnil Chavan's PERSONAL ACCOUNT.

ADDRESS: - 315, 3rd Floor, Sai Trade Centre, Near Mayor Bungalow, Railway Station Road,  
Aurangabad Maharashtra, India

Contact. +919422925422 Email. mundadagirish@gmail.com



# LOYA & MUNDADA

CHARTERED ACCOUNTANTS

24. Out of this Rs. 1,23,07,400/- an amount of Rs. 47,55,000/- was unauthorisedly transfer to Swapnil Chavan's mother's PERSONAL ACCOUNT i.e. Sneha Baban Chavan's account.
25. Out of this Rs. 1,23,07,400/- an amount of Rs. 30,00,000/- (equivalent to UAE dirhams of 145,915.19/-) was unauthorisedly transfer to Swapnil Chavan's FIRM POTOMAC AVIATION in UAE, having an account with NOOR BANK.
26. Annex 7 has details of all funds transfer transactions of Rs. 1,23,07,400/- from afore mentioned accounts to Swapnil Chavan's personal accounts, Sneha Baban Chavan's account and Potomac Aviation account in UAE.
27. Mr. ATUL SURENDRA PANDEY has transactions of a total amount of Rs. 48,34,000/- from SANGEETA AVIATION SERVICES PVT LTD Exclusively.
28. Out of this Rs. 48,34,000/- an amount of Rs. 37,34,000/- was unauthorisedly transfer to Atul Pandey's PERSONAL ACCOUNT.
29. Out of this Rs. 48,34,000/- an amount of Rs. 11,00,000/- was transfer to Atul Pandey's mother's PERSONAL ACCOUNT i.e. RAJINI SURENDRA PANDEY's account.
30. Annex 8 has details of all funds transfer transactions of Rs. 48,34,000/- from afore mentioned accounts to Atul Pandey's personal account and Rajini Surendra Pandey's account.
31. We as independent auditors shall be available at your convenience, in case any further clarifications or supporting documents would be required in this scrutiny or investigation. Thank you. Sincerely,

Chartered Accountant  
Firm Registered with  
CA Chetan G. Mundada  
Member of ICAI



ADDRESS: - 315, 3rd Floor, Sai Trade Centre, Near Mayor Bungalow, Railway Station Road,

Aurangabad Maharashtra, India

Contact. +919422925422 Email. mundadagirish@gmail.com

**SUPREME TRANSPORT ORGANISATION PRIVATE LIMITED**

**PAN : AAMCS0611A**

**Statutory Audit Report**

Financial Year : 2019-2020

Assessment Year : 2020-2021

Date of Audit Report : 23/12/2020



**C P PATEL & ASSOCIATES**

**Prop. Chirag Patel**

**Chartered Accountants**

## INDIAN INCOME TAX RETURN ACKNOWLEDGEMENT

[Where the data of the Return of Income in Form ITR-1 (SALAJ), ITR-2, ITR-3,  
ITR-4 (SUGAM), ITR-5, ITR-6, ITR-7 filed and verified]  
(Please see Rule 12 of the Income-tax Rules, 1962)

Assessment Year  
**2020-21**

PAN	AAMCS0611A		
Name	SUPREME TRANSPORT ORGANISATION PRIVATE LIMITED		
Address	34 BUILDING NO.5B, SIR MATHURADAS VASANJIRO, AKSHAY MITTAL IND ESTATE, ANDHERI, MUMBAI, MAHARASHTRA, 400059		
Status	Pvt Company	Form Number	ITR-6
Filed u/s	139(1)-On or before due date	e-Filing Acknowledgement Number	169214581100121
Taxable Income and Tax details	Current Year business loss, if any	1	49364333
	Total Income		0
	Book Profit under MAT, where applicable	2	0
	Adjusted Total Income under AMT, where applicable	3	0
	Net tax payable	4	0
	Interest and Fee Payable	5	0
	Total tax, interest and Fee payable	6	0
	Taxes Paid	7	3223565
(+)Tax Payable /(-)Refundable (6-7)	8	-3223570	
Dividend Tax Distribution Tax details	Dividend Tax Payable	9	0
	Interest Payable	10	0
	Total Dividend tax and interest payable	11	0
	Taxes Paid	12	0
	(+)Tax Payable /(-)Refundable (11-12)	13	0
Accreted Income & Tax Detail	Accreted Income as per section 115TD	14	0
	Additional Tax payable u/s 115TD	15	0
	Interest payable u/s 115TE	16	0
	Additional Tax and interest payable	17	0
	Tax and interest paid	18	0
	(+)Tax Payable /(-)Refundable (17-18)	19	0

Income Tax Return submitted electronically on 10-01-2021 00:57:25 from IP address 49.32.198.224 and verified by KAMAL N AGARWAL

having PAN ABMPA1774E on 10-01-2021 00:57:25 from IP address 49.32.198.224 using Digital Signature Certificate (DSC).

DSC details: 81426166505812CN=Vernsys CA  
2014.2.5.4.51=#13294f666696365204e6f2e2032312c20326e6420466c6f6f722c20426861766e61204275696c64696e67,STREET=V.S.

**DO NOT SEND THIS ACKNOWLEDGEMENT TO CPC, BENGALURU**



**INDEPENDENT AUDITOR'S REPORT**

TO THE MEMBERS OF

SUPREME TRANSPORT ORGANISATION PRIVATE LIMITED

**Report on the Financial Statements**

We have audited the accompanying financial statements of SUPREME TRANSPORT ORGANISATION PRIVATE LIMITED ("the Company"), which comprises the Balance Sheet as at March 31, 2020, the Statement of Profit and Loss and Cash Flow Statement for the year then ended, and a summary of significant accounting policies and other explanatory information.

**Opinion**

In our opinion and to the best of our information and according to the explanations given to us, the aforesaid financial statements give the information required by the Companies Act, 2013 ("the Act") in the manner so required and give a true and fair view in conformity with the Indian Accounting Standards prescribed under section 133 of the Act read with the Companies (Indian Accounting Standards) Rules, 2015, as amended, ("IndAS") and other accounting principles generally accepted in India, of the state of affairs of the Company as at March 31, 2020, and its cashflows for the year ended on that date except for the matters referred in emphasis of matter.

**Basis of Opinion**

We conducted our audit of financial statements in accordance with the Standards on Auditing specified under section 143(10) of the Act (SAs). Our responsibilities under those Standards are further described in the Auditor's Responsibilities for the Audit of the Financial Statements section of our report. We are independent of the Company in accordance with the Code of Ethics issued by the Institute of Chartered Accountants of India (ICAI) together with the independence requirements that are relevant to our audit of the financial statements under the provisions of the Act and the Rules made thereunder, and we have fulfilled our other ethical responsibilities in accordance with these requirements and the ICAI's Code of Ethics. We believe that the audit evidence we have obtained is sufficient and appropriate to provide a basis for our audit opinion on the financial statements.

**Emphasis of Matter**

We invite attention to:

1. The Note No.4 regarding loans; the closing balances of all loans are not yet confirmed by the balance confirmation from banks/FI's. It also states the ongoing litigation between Kotak Bank and STOPL and Axis Bank and STOPL. Both these loans are under SARFAESI as on date.

The closing balance of loans does not reflect penal interest portion on the loans which the company has not accepted.

As described in Note 4 and Note 23 to the financial statements, Company has calculated closing balance as per the books considering repayment made as per bank statements as on March 31, 2020 in respect of loans from Kotak Bank, IndusInd bank, Shriram Transport Finance Limited, Indostar, Axis bank due to non-availability of closing balance confirmation from banks as on the date of signing of audit report. The

Statement of Account provided by banks does not give clarity regarding the closing balances as on March 31, 2020. Moreover Company does not agree with charging of penal interest by banks as Company wants to handover possession of assets to banks against the loans. There are litigations going on in respect of Terms Loans and CC of Kotak Mahindra Bank and Aircraft loan Of Axis Bank for settlement of loans. Also, Kotak Mahindra Bank has sold off flat no 143 and flat no 233 which were sold off for recovery of loans against those properties under the SARFAESI Act, 2002. However, company has objected to this selling due to improper auction procedure and the same is in litigation. In view of the lack of clarity in terms of settlement the said properties have been still shown in books as also the loan outstanding for which these properties were mortgaged. So, in absence of sufficient and appropriate evidence we are unable to comment on the exact closing balance of Loans and the possible impact of the Interest on the profitability of financial statements as on March 31, 2020.

With reference to Note No. 6, 11, 12 & 14 regarding the balance of Sundry Creditors, Debtors, Loans and Advances, Deposits not confirmed by the parties and hence our inability to state whether these balances are recoverable/payable to the extent stated.

2. The Company has given loans to directors which to the tune of Rs 19, 30,000 violating section 185 of the Companies Act 2013

#### **Information Other than the Financial Statements and Auditor's Report Thereon**

The Company's Management is responsible for the preparation of the other information. The other information comprises the information included in the Board's Report including Annexure to Board's Report, Management Discussion and Analysis/ Business Responsibility Report/Corporate Governance and Shareholder's Information, but does not include the financial statements and our auditor's report thereon. The above-referred information is expected to be made available to us after the date of this audit report.

Our opinion on the financial statements does not cover the other information and we do not express any form of assurance conclusion thereon.

In connection with our audit of the financial statements, our responsibility is to read the other information identified above when it becomes available and, in doing so, consider whether the other information is materially inconsistent with the financial statements or our knowledge obtained during the course of our audit or otherwise appears to be materially misstated. If, based on the work we have performed, we conclude that there is a material misstatement of this other information; we are required to report that fact.

When we read the other information, if we conclude that there is a material misstatement therein, we are required to communicate the matter to those charged with governance and take appropriate actions necessitated by the circumstances and the applicable laws and regulations.

#### **Responsibilities of Management and Those Charged with Governance for the Financial Statements**

The Company's management is responsible for the matters stated in Section 134(5) of the Companies Act, 2013 ("the Act") with respect to the preparation of these financial statements that give a true and fair view of the financial position, financial performance, changes in equity and cash flows of the Company in accordance with the accounting principles generally accepted in India, including the Accounting Standards specified under Section 133 of the Act, read with Rule 7 of the Companies (Accounts) Rules, 2014. This responsibility also includes maintenance of adequate accounting records in accordance with the provisions of the Act for safeguarding of the assets of the Company and for preventing and detecting frauds and other irregularities; selection and application of appropriate accounting policies; making judgments and estimates that are reasonable and prudent; and design, implementation and maintenance of adequate internal financial controls, that were operating effectively for ensuring the accuracy and completeness of the accounting records, relevant to the preparation and presentation of the financial statements that give a true and fair view and are free from material misstatement, whether due to fraud or error.

In preparing the financial statements, management is responsible for assessing the Company's ability to continue as a going concern. The Management is responsible for overseeing the Company's financial reporting process.

### Auditor's Responsibility for the Audit of the Financial Statements

Our objectives are to obtain reasonable assurance about whether the financial statements as a whole are free from material misstatement, whether due to fraud or error, and to issue an auditor's report that includes our opinion. Reasonable assurance is a high level of assurance, but is not a guarantee that an audit conducted in accordance with SAs will always detect a material misstatement when it exists. Misstatements can arise from fraud or error and are considered material if, individually or in the aggregate, they could reasonably be expected to influence the economic decisions of users taken on the basis of these financial statements.

As part of an audit in accordance with SAs, we exercise professional judgment and maintain professional skepticism throughout the audit. We also:

- Identify and assess the risks of material misstatement of the financial statements, whether due to fraud or error, design and perform audit procedures responsive to those risks, and obtain audit evidence that is sufficient and appropriate to provide a basis for our opinion. The risk of not detecting a material misstatement resulting from fraud is higher than for one resulting from error, as fraud may involve collusion, forgery, intentional omissions, misrepresentations, or the override of internal control.
- Obtain an understanding of internal financial controls relevant to the audit in order to design audit procedures that are appropriate in the circumstances. Under section 143(3)(i) of the Act, we are also responsible for expressing our opinion on whether the Company has adequate internal financial controls system in place and the operating effectiveness of such controls
- Evaluate the appropriateness of accounting policies used and the reasonableness of accounting estimates and related disclosures made by management.
- Conclude on the appropriateness of management's use of the going concern basis of accounting and, based on the audit evidence obtained, whether a material uncertainty exists related to events or conditions that may cast significant doubt on the Company's ability to continue as a going concern. If we conclude that a material uncertainty exists, we are required to draw attention in our auditor's report to the related disclosures in the financial statements or, if such disclosures are inadequate, to modify our opinion. Our conclusions are based on the audit evidence obtained up to the date of our auditor's report. However, future events or conditions may cause the Company to cease to continue as a going concern.
- Evaluate the overall presentation, structure and content of the financial statements, including the disclosures, and whether the financial statements represent the underlying transactions and events in a manner that achieves fair presentation.

Materiality is the magnitude of misstatements in the financial statements that, individually or in aggregate, makes it probable that the economic decisions of a reasonably knowledgeable user of the financial statements may be influenced. We consider quantitative materiality and qualitative factors in (i) planning the scope of our audit work and in evaluating the results of our work; and (ii) to evaluate the effect of any identified misstatements in the financial statements.

We communicate with those charged with governance regarding, among other matters, the planned scope and timing of the audit and significant audit findings, including any significant deficiencies in internal control that we identify during our audit.

We also provide those charged with governance with a statement that we have complied with relevant ethical requirements regarding independence, and to communicate with them all relationships and other matters that may reasonably be thought to bear on our independence, and where applicable, related safeguards.

From the matters communicated with those charged with governance, we determine those matters that were of most significance in the audit of the financial statements of the current period and are therefore the key audit matters. We describe these matters in our auditor's report unless law or regulation precludes public disclosure about the matter or when, in extremely rare circumstances, we determine that a matter should not be communicated in our report because the adverse consequences of doing so would reasonably be expected to outweigh the public interest benefits of such communication.

#### Report on Other Legal and Regulatory Requirements

1. As required by Section 143(3) of the Act, based on our audit we report that:

a) We have sought and obtained all the information and explanations which to the best of our knowledge and belief were necessary for the purposes of our audit.

b) In our opinion proper books of account as required by law have been kept by the Company so far as appears from our examination of those books.

c) The Balance Sheet and the Statement of Profit and Loss including the Statement of Cash Flow dealt with by this Report are in agreement with the books of account.

d) In our opinion, the aforesaid financial statements comply with the Accounting Standards specified under Section 133 of the Act, read with Rule 7 of the Companies (Accounts) Rules, 2014.

e) On the basis of the written representations received from the directors as on 31st March, 2020 taken on record by the Board of Directors, none of the directors is disqualified as on 31st March, 2020 from being appointed as a director in terms of Section 164 (2) of the Act.

f) With respect to the adequacy of the internal financial controls with reference to financial statements of the Company and the operating effectiveness of such controls, refer to our separate Report in "Annexure A". Our report expresses an unmodified opinion on the adequacy and operating effectiveness of the Company's Internal Financial Controls with reference to financial statements.

g) With respect to the other matters included in the Auditor's Report in accordance with Rule 11 of the Companies (Audit and Auditors) Rule, 2014, in our opinion and to the best of our information and according to the explanation given to us and to the best of our information and according to the explanations given to us:

i. The company has disclosed the impact of pending litigation on its financial position in its financial statements;

ii. The Company did not have any long-term contracts including derivative contracts for which there were any material foreseeable losses;

iii. There has been no delay in transferring amounts, required to be transferred, to the Investor Education and Protection Fund by the Company.

2. As required by the Companies (Auditor's Report) Order, 2016("the Order"), issued by the Central Government of India in terms of sub-section (11) of Section 143 of the Act, we give in "Annexure B" a statement on the matters specified in paragraphs 3 and 4 of the Order.

For C P Patel & Associates  
Chartered Accountants  
Firm Registration No.: 142609W

*CP Patel*

Chirag Patel  
Proprietor  
Membership No.: 128407  
UDIN: 21128407AAAAAE8002  
Date: 23/12/2020  
Place: Thane





**ANNEXURE "A" TO THE INDEPENDENT AUDITOR'S REPORT**

(Referred to in paragraph 1(f) under 'Report on Other Legal and Regulatory Requirements' section of our report to the Members of Supreme Transport Organisation Private Limited of even date)

Report on the Internal Financial Controls with reference to Financial Statements under Clause (i) of Sub-section 3 of Section 143 of the Companies Act, 2013 ("the Act")

We have audited the Internal Financial Controls with reference to financial statements of SUPREME TRANSPORT ORGANISATION PRIVATE LIMITED ("the Company") as of March 31, 2020 in conjunction with our audit of the financial statements of the Company for the year ended on that date.

**Management's Responsibility for Internal Financial Controls**

The Management of the Company is responsible for establishing and maintaining Internal financial controls based on the internal control over financial reporting criteria established by the Company considering the essential components of internal control stated in the Guidance Note on Audit of Internal Financial Controls with reference to financial statements issued by the Institute of Chartered Accountants of India ("ICAI"). These responsibilities include the design, implementation and maintenance of adequate internal financial controls that were operating effectively for ensuring the orderly and efficient conduct of its business, including adherence to company's policies, the safeguarding of its assets, the prevention and detection of frauds and errors, the accuracy and completeness of the accounting records, and the timely preparation of reliable financial information, as required under the Companies Act, 2013.

**Auditors' Responsibility**

Our responsibility is to express an opinion on the Company's Internal Financial Controls with reference to financial statements based on our audit. We conducted our audit in accordance with the Guidance Note on Audit of Internal Financial Controls with reference to financial statements (the "Guidance Note") issued by the Institute of Chartered Accountants of India and the Standards on Auditing, issued by ICAI and deemed to be prescribed under section 143(10) of the Companies Act, 2013, to the extent applicable to an audit of internal financial controls, both issued by the Institute of Chartered Accountants of India. Those Standards and the Guidance Note require that we comply with ethical requirements and plan and perform the audit to obtain reasonable assurance about whether adequate Internal Financial Controls with reference to financial statements was established and maintained and if such controls operated effectively in all material respects.

Our audit involves performing procedures to obtain audit evidence about the adequacy of the Internal Financial Controls with reference to financial statements and their operating effectiveness. Our audit of Internal Financial Controls with reference to financial statements included obtaining an understanding of Internal Financial Controls with reference to financial statements, assessing the risk that a material weakness exists, and testing and evaluating the design and operating effectiveness of internal control based on the assessed risk. The procedures selected depend on the auditor's judgment, including the assessment of the risks of material misstatement of the financial statements, whether due to fraud or error.

We believe that the audit evidence we have obtained is sufficient and appropriate to provide a basis for our audit opinion on the Company's Internal Financial Controls with reference to financial statements.

### Meaning of Internal Financial Controls with reference to financial statements

A company's Internal Financial Controls with reference to financial statements is a process designed to provide reasonable assurance regarding the reliability of financial reporting and the preparation of financial statements for external purposes in accordance with generally accepted accounting principles. A company's Internal Financial Controls with reference to financial statements includes those policies and procedures that (1) pertain to the maintenance of records that, in reasonable detail, accurately and fairly reflect the transactions and dispositions of the assets of the company; (2) provide reasonable assurance that transactions are recorded as necessary to permit preparation of financial statements in accordance with generally accepted accounting principles, and that receipts and expenditures of the company are being made only in accordance with authorizations of management and directors of the company; and (3) provide reasonable assurance regarding prevention or timely detection of unauthorized acquisition, use, or disposition of the company's assets that could have a material effect on the financial statements.

### Inherent Limitations of Internal Financial Controls with reference to financial statements

Because of the inherent limitations of Internal Financial Controls with reference to financial statements, including the possibility of collusion or improper management override of controls, material misstatements due to error or fraud may occur and not be detected. Also, projections of any evaluation of the Internal Financial Controls with reference to financial statements to future periods are subject to the risk that the Internal Financial Controls with reference to financial statements may become inadequate because of changes in conditions, or that the degree of compliance with the policies or procedures may deteriorate.

### Opinion

In our opinion, the Company, have in all material respects, an adequate Internal Financial Controls with reference to financial statements and such Internal Financial Controls with reference to financial statements were operating effectively as at 31 March 2020, based on the internal control over financial reporting criteria established by the Company considering the essential components of internal control stated in the Guidance Note on Audit of Internal Financial Controls with reference to financial statements issued by the Institute of Chartered Accountants of India.

For C P Patel & Associates  
Chartered Accountants  
Firm Registration No.: 142609W

*C. Patel*

Chirag Patel  
Proprietor  
Membership No.: 128407  
UDIN: 21128407AAAAAE8002  
Date: 23/12/2020  
Place: Thane





ANNEXURE "B" TO THE INDEPENDENT AUDITOR'S REPORT

(Referred to in paragraph 2 under 'Report on Other Legal and Regulatory Requirements' section of our report to the Members of Supreme Transport Organisation Private Limited of even date)

i. In respect of the Company's fixed assets:

(a) The company has maintained proper records showing full particulars including quantitative details and situation of fixed assets.

(b) A substantial portion of fixed assets has been physically verified by the management during the year and in our opinion the frequency of verification is reasonable having regard to the size of the company, the nature of its assets.

According to the information given to us and to the best of our knowledge, no material discrepancies were noticed on such physical verification.

(c) According to the information and explanations given to us and the records examined by us, we report that, the title deeds, comprising the immovable property of Land, are held in the name of company as at the balance sheet date.

ii. (a) As explained to us, the Inventory has been physically verified by the management at reasonable intervals during the year.

(b) In our opinion and according to the information and explanations given to us, no material discrepancies were noticed on physical verification.

iii. According to the information and explanations given to us and the records examined by us, the Company has complied with section 189 of the Companies Act, 2013 wherever applicable.

iv. In our opinion and according to the information and explanations given to us, the Company has complied with section 185 and 186 of the Companies Act, 2013 wherever applicable. Except to the extent of Rs 19, 30,000 temporary loan given to director for exigency purpose.

v. According to the information and explanations given to us, the company has not accepted deposits during the year. The company generally complied with the provisions of Sections 73 to 76 or any other relevant provisions of the Companies Act, 2013.

vi. According to the information and explanations given to us, cost records as prescribed by the central Government under Section 148(1) of the Companies Act, 2013 are not required to be maintained.

vii. (a) According to the information and explanations given to us and the records examined by us, in our opinion, the company has generally been regular in depositing with appropriate authorities undisputed statutory dues including Provident Fund, Employees' State Insurance, Income-tax, Service tax, value added tax, except Goods and Service tax which is delayed due to cash flow mismatch, cess and any other material statutory dues applicable to it. There were no arrears of such dues at the year end which have remain outstanding for a period of more than six months from the date they became payable.

(b) According to the information and explanations given to us and the records examined by us, company has no dues in respect of Income Tax, Service Tax, GST and value added tax which has not been deposited on account of any dispute except delayed payments of GST due to mismatch of receipt of revenue.

viii) Based on the audit procedure and according to the information and explanations given to us, we are of the opinion that the company has defaulted in repayment of principal and/or interest to banks, financial institutions wherein the period of delay ranges from 1 to 365 days and in some cases more than 365 days.

The exact penal interests as well as other charges are not ascertainable as no balance confirmation has been received from the banks and most of the loans are under SARFAESI.

ix) The company has not raised moneys by way of further public offer. Further, in our opinion and according to the information and explanations given to us, the moneys raised by way of debt instruments and term loans have been applied by the company during the year for the purposes for which they are raised.

x.) To the best of our knowledge and according to the information and explanations given to us, no fraud by the company and no material fraud on the company by its officers or employees, noticed or reported to us by the management during the year Management's Responsibility for the Financial Statements

xi) Since the company is a Private Limited company, provisions of sections 197 read with schedule V of the Act regarding payment of managerial remunerations is not applicable.

xii. In our opinion and according to the information and explanations given to us, Company is not a Nidhi Company.

Accordingly reporting under paragraph 3(xii) of the Order is not applicable.

xiii. In our opinion and according to the information and explanations given to us, transactions entered by the Company with related parties are in compliance with section 188 of the Act, to the extent applicable. Being an unlisted Company provisions of section 177 of the Act are not applicable. In our opinion, details of transactions with the related parties have been disclosed in the financial statements as required by the applicable accounting standards.

xiv. According to the information and explanations given to us and based on our examination of the records of the Company, the Company has not made any preferential allotment or private placement of shares or fully or partly convertible debentures during the year and hence reporting under clause 3(xiv) are not applicable to the company.

xv. According to the information and explanations given to us and based on our examination of the records of the Company, the Company has not entered into non-cash transactions with directors or persons connected with him. Accordingly, reporting under paragraph 3(xv) of the Order are not applicable.

xvi. The company is not required to be registered under section 45-IA of the Reserve Bank of India Act, 1934.

For C P Patel & Associates  
Chartered Accountants  
Firm Registration No.: 142609W

*cpatel*

Chirag Patel  
Proprietor  
Membership No.: 128407  
UDIN: 21128407AAAAAE8002  
Date: 23/12/2020  
Place: Thane



Supreme Transport Organisation Private Limited  
CIN : U60230MH2008PTC216143  
Balance Sheet as at 31st March 2020

Particulars	Note	Amount (Rs.)	
		As at 31st March, 2020	As at 31st March, 2019
<b>A EQUITY &amp; LIABILITIES</b>			
<b>1 Shareholders' Funds</b>			
(a) Share capital	2	7,00,00,000	7,00,00,000
(b) Reserves & surplus	3	(1,69,56,353)	3,16,20,532
		5,30,43,647	10,16,20,532
<b>2 Non Current Liabilities</b>			
(a) Long-term borrowings	4	17,02,46,059	19,09,31,868
(b) Long term Provisions		-	-
(b) Deferred Tax Liabilities		6,27,38,155	6,04,40,227
		23,29,84,213	25,13,72,035
<b>3 Current Liabilities</b>			
(a) Short-term borrowings	5	(1,77,73,503)	1,45,50,850
(b) Trade payables	6	5,18,74,067	10,17,14,478
(c) Other current liabilities	7	26,29,62,133	25,06,43,345
(d) Short-term provisions	8	2,18,70,804	2,18,70,804
		31,89,33,501	38,87,79,477
		<b>60,49,61,361</b>	<b>74,17,72,043</b>
<b>B ASSETS</b>			
<b>1 Non-current assets</b>			
<b>(a) Fixed assets</b>			
(i) Tangible Assets	9	28,40,49,565	32,79,87,110
(ii) Capital Work in Progress		-	-
(b) Non-current investments	10	11,54,87,330	11,54,87,330
(c) Long Term loans and advances	11	2,76,69,041	2,48,35,854
(d) Deferred Tax Assets		42,72,05,937	46,83,10,294
<b>2 Current Assets</b>			
(a) Trade Receivables	12	6,38,28,999	12,10,48,989
(b) Cash & cash equivalents	13	47,25,883	17,58,545
(c) Short term loan and advances	14	10,92,00,543	15,06,54,214
(d) Other Current Assets	15	-	-
		17,77,55,425	27,34,61,748
		<b>60,49,61,361</b>	<b>74,17,72,043</b>

Significant Accounting Policies 1  
Notes on Financial Statements 2 to 28

As per our separate report of even date

For, C P Patel & Associates  
Chartered Accountants  
F.R.N. 142609W

Chirag Patel  
Proprietor  
Membership No. 128407  
UDIN : 21128407AAAAAE8002

Date : 23-12-2020  
Place: Mumbai

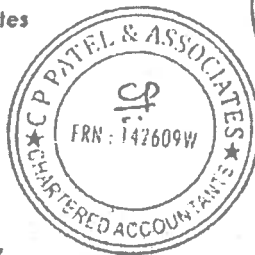

For and on behalf of the Board

Shri Kamal Agarwal  
Chairman & Managing Director  
DIN No. 1252090

H.E. Captain Ammeet K Agarwal  
Director  
DIN : 05293676

Date : 23-12-2020  
Place: Mumbai

Supreme Transport Organisation Private Limited  
 CIN : U60230MH2008PTC216143  
 Statement of Profit & Loss for the year ended on March 2020

Particulars	Note	Amount (Rs.)	
		For the Period Ended 31st March 2020	For the Period Ended 31st March 2019
1 Revenue from Operations	16	20,07,41,360	34,37,22,523
		20,07,41,360	34,37,22,523
2 Other Income	17	1,63,46,589	2,10,82,836
<b>3 Total Revenue</b>		<b>21,70,87,949</b>	<b>36,48,05,359</b>
<b>Expenses</b>			25,62,69,691
Purchase of Stock in Trade	18	10,14,61,353	-
Purchases of Shares	19	2,87,12,604	5,56,14,127
Employee Benefits expense	20	35,32,697	2,00,78,268
Finance Costs(Net)	20	4,18,98,515	5,39,50,190
Depreciation	21	8,75,88,989	9,42,78,974
Other Expenses			
<b>4 Total Expenses</b>		<b>26,31,94,157</b>	<b>48,01,91,251</b>
<b>5 Profit before tax</b>		<b>(4,61,06,208)</b>	<b>(11,53,85,891)</b>
<b>6 Provision for Tax</b>			
Current		(1,72,749)	(68,52,907)
Short/Excess Provision		(22,97,928)	(68,52,907)
Deferred		(24,70,677)	
<b>7 Profit for the period</b>		<b>(4,85,76,865)</b>	<b>(12,22,38,798)</b>
<b>8 Earnings Per Share</b>			
Basic & Diluted	22	-6.94	-17.46

Significant Accounting Policies  
 Notes on Financial Statements

1  
 2 to 28

As per our separate report of even date

For, C P Patel & Associates  
 Chartered Accountants  
 F.R.N. 142609W

Chirag Patel  
 Proprietor  
 Membership No. 128407  
 UDIN :21128407AAAAAE8002

Date : 23-12-2020  
 Place: Mumbai

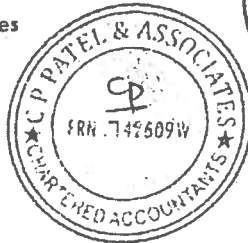

For and on behalf of the Board  
 Shri Kamal Agarwal  
 Chairman & Managing Director  
 DIN No. 1252090

H.E. Captain Ammeet K Agarwal  
 Director  
 DIN : 05293676

Date : 23-12-2020  
 Place: Mumbai

supreme Transport Organisation Private Limited  
 CIN : U60230MH2008PTC216143  
 Cash Flow Statement for the year ended on 31st March, 2020

Particulars	For the Year Ended 31st March, 2020		For the Year Ended 31st March, 2019	
<b>A. Cash Flow from Operating Activities</b>				
Net Profit Before Taxation and extra ordinary Items		(4,61,06,208)		(11,53,85,891)
<u>Adjustment for Non Operating &amp; Non Cash Items:</u>				
- Depreciation & Amortisation	4,13,98,515		53,25,190.47	
- Amount Written Off			-	
- Profit on Sale of Assets	(1,26,55,583)		(2,06,05,300)	
- Dividend Income			-	
- Profit on Sale of Mutual Funds			-	
- Bad Debt Written Off			-	
- Long Term Provision			-	
- Short/Excess Provision			-	
- Finance Cost	35,32,697	3,27,75,629	2,00,78,268	5,34,23,152
Operating Profit before working capital changes		<u>(1,33,30,579)</u>		<u>(6,19,62,733)</u>
<b>Changes in working capital</b>				
<b>Adjustment for Increase / Decrease In Operating Assets</b>				
- Inventories	0		-	
- Trade Receivable	5,72,19,990		20,35,96,809	
- Long Term Loans & Advances	-		-	
- Short Term Loans & Advances	4,14,53,671		(5,06,10,005)	
- Other Current Assets	-		5,00,717	
	<u>9,86,73,661</u>		<u>15,34,87,521</u>	
<b>Adjustment for Increase / Decrease In Operating Liabilities</b>				
- Trade Payable	(4,98,40,411)		74,95,548	
- Other Current Liabilities	1,23,18,788		12,28,14,622	
- Other Short Term Provisions	-		-	
- Short Term Borrowings	(3,23,24,353)		(13,20,92,811)	
	<u>(6,98,45,976)</u>	<u>2,88,27,685</u>	<u>(17,82,641)</u>	<u>15,17,04,881</u>
Cash Flow from Extra Ordinary Items				
Cash Generated from Operations		<u>1,54,97,106</u>		<u>8,97,42,147</u>
Net Taxes Paid		(24,70,677)		(68,52,907)
<b>Net Cash Flow from / (used In) Operating Activities (A)</b>		<u>1,30,26,429</u>		<u>8,28,89,240</u>
<b>B. Cash Flow from Investing Activities</b>				
- Expenditure of Fixed Assets(Net) & Capital WIP	(80,372)		(3,15,22,366)	
- Capital Work In Progress	-		3,02,08,795	
- Dividend Income			-	
- Proceeds on sale of Investments			-	
- Long Term loans & advances	(28,33,187)		(28,61,259)	
- Current Investments			-	
- Cashflow from Disposal of asset	1,47,74,985		5,30,92,567	
- Non Current Investment			-	
<b>Net Cash Flow from / (used In) Investing Activities (B)</b>		<u>1,18,61,426</u>		<u>4,89,17,737</u>

Supreme Transport Organisation Private Limited  
 CIN : U60230MH2008PTC216143  
 Cash Flow Statement for the year ended on 31st March, 2020

Particulars	For the Year Ended 31st March, 2020	For the Year Ended 31st March, 2019
<b>C. Cash Flow from Financing Activities</b>		
- Amount Paid on Buy-back of Shares (Incl. Taxes thereon)		
- Proceeds of Long Term Borrowings	(2,06,85,749)	(12,88,29,744)
- Proceeds of Short Term Borrowings		
- Proceeds of Long Term Provisions	22,97,928	68,52,908
- Tax on Dividend		
- Finance Cost	(35,32,697)	(2,00,78,268)
- Dividend Paid		
<b>Net Cash Flow from / (used In) Financing Activities (C)</b>	<b>(2,19,20,518)</b>	<b>(14,20,55,104)</b>
<b>Net Increase / (Decrease) In Cash &amp; Cash Equivalents (A+B+C)</b>	<b>29,67,336</b>	<b>(1,02,48,127)</b>
Cash & Cash Equivalent at the beginning of the Year	17,58,545	1,20,06,673
<b>Cash &amp; Cash Equivalent at the end of the Year</b>	<b>47,25,883</b>	<b>17,58,545</b>
<b>Components of Cash &amp; Cash Equivalents:</b>		
Cash on Hand	18,43,360	14,994
With Bank	28,82,523	17,43,551
<b>Total Cash &amp; Bank Balances</b>	<b>47,25,883</b>	<b>17,58,545</b>

**Notes:**

- (i) The Cash Flow Statement reflects the combined cash flows pertaining to continuing and discounting operations.  
 (ii) These earmarked account balances with banks can be utilised only for the specific identified purposes.

As per our separate report of even date

For, C P Patel & Associates  
 Chartered Accountants  
 F.R.N.142609W

*Cpatel*

Chirag Patel  
 Proprietor  
 Membership No. 128407  
 UDIN : 21128407AAAAAE8002

Date : 23-12-2020  
 Place: Mumbai



For and on behalf of the Board

*[Signature]*  
 Shri Kamal Agarwal  
 Chairman & Managing Director  
 DIN No. 1252090

*[Signature]*  
 H.E. Captain Ammeet K Agarwal  
 Director  
 DIN : 05293676

Date : 23-12-2020  
 Place: Mumbai



Particulars			As at	As at
	Number of Shares (C.Y)	Number of Shares (P.Y)	31st March 2020	31st March 2019
<b>Note 2: Share capital</b>				
(a) Authorised share capital Equity shares of ₹ 10/- each	2,00,00,000	2,00,00,000	20,00,00,000	20,00,00,000
(b) Issued Equity shares of ₹ 10/- each	70,00,000	70,00,000	7,00,00,000	7,00,00,000
(c) Subscribed & fully paid up Equity shares of ₹ 10/- each	70,00,000	70,00,000	7,00,00,000	7,00,00,000
		<b>Total</b>	<b>7,00,00,000</b>	<b>7,00,00,000</b>
		<b>Total</b>	<b>7,00,00,000</b>	<b>7,00,00,000</b>

Notes:

(i) Details of shares held by each shareholder holding more than 5% shares:

Name of Shareholders	No. of Shares (C.Y)	% holding in that class of shares	No. of Shares (P.Y)	% holding in that class of shares
Kamal Agarwal	36,40,000	52%	36,40,000	52%
Vimal Agarwal	8,40,000	12%	8,40,000	12%
Grish Agarwal	8,40,000	12%	8,40,000	12%
Holding under Prejudice	8,40,000	12%	8,40,000	12%
Holding under Prejudice	8,40,000	12%	8,40,000	12%

(ii) The Reconciliation of the number of shares outstanding at the beginning and at the end of the reporting period.

Particulars	As at 31st March, 2020		As at 31st March, 2019	
	No. of Shares (C.Y)	Amount (Rs)	No. of Shares (P.Y)	Amount (Rs)
Equity Shares at the beginning of the year	70,00,000	7,00,00,000	70,00,000	7,00,00,000
Shares Extinguished pursuant to Buy-back (Refer Note-32)	-	-	-	-
Shares issued pursuant to Bonus Issue @ 1:2	-	-	-	-
Equity Shares at the end of the year	70,00,000	7,00,00,000	70,00,000	7,00,00,000

**Note 3: Reserves & surplus**

**Surplus**

Balance in Profit & Loss Account

3,16,20,532

15,38,59,330

Add: Net Profit for the year

(4,85,76,885)

(12,22,38,798)

(1,69,56,353)

3,16,20,532

**Total** (1,69,56,353) 3,16,20,532

**Note 4: Long-term borrowings**

**A- Secured**

**From Banks**

Kotak Mahindra Bank - 0681DL010000023

42,13,288

42,13,288

Kotak Mahindra Bank - 0681DL010000024

79,22,030

79,22,030

Kotak Mahindra Bank - 0681DL0110000017

3,40,45,099

3,40,45,099

Axis Bank Term Loan - 917060029132404

10,50,50,000

10,71,21,595

15,12,30,417

15,33,02,012

(Note 1 : All above mentioned Commercial loans are secured by mortgage of movable & immovable properties registered in the name of company)

**From Other than Bank**

**Secured Loans**

1,27,05,211

2,58,66,559

1,27,05,211

2,58,66,559

(Note 2 : These loans are secured by mortgage of commercial vehicles registered in the name of company)

**A- Unsecured**

**From Directors**

4,49,272

9,02,578

**From Companies**

58,61,159

1,08,60,659

63,10,431

1,17,63,237

**Total** 17,02,46,059 19,09,31,808

Particulars	As at 31st March 2020	As at 31st March 2019
<b>Note 5: Short-term borrowings</b>		
<b>Secured</b>		
<b>Cash Credit</b>		
From Kotak Mahindra Bank Ltd.- Cash Credit - 02072980000064	(1,77,73,503)	1,25,96,830
BUSINESS LOAN i 4948797	-	19,54,020
Other Loans & Advances	-	-
<b>Total</b>	<b>(1,77,73,503)</b>	<b>1,45,50,850</b>
<b>Note 6: Trades payables</b>		
Trade payables - For goods		
	5,18,74,067	10,17,14,478
<b>Total</b>	<b>5,18,74,067</b>	<b>10,17,14,478</b>
<b>Note 7: Other current liabilities</b>		
<b>Other Payable</b>		
(i) Advance from customers	16,45,79,339	12,11,21,533
(ii) Other Liabilities	9,83,82,794	5,31,31,812
<b>Total</b>	<b>26,29,62,133</b>	<b>25,06,43,345</b>
<b>Note 8: Short-term provisions</b>		
Provision for Taxation		
	2,18,70,804	2,18,70,804
<b>Total</b>	<b>2,18,70,804</b>	<b>2,18,70,804</b>
<b>Note 10: Non-current Investments</b>		
<b>(a) Quoted Investments</b>		
<b>(b) Unquoted Investments</b>		
<b>1) Equity Instruments</b>		
The Kalapur Commercial Co. Op. Bank Ltd.	9,330	9,330
Vardhman Enterprises Ltd.	3,500	3,500
<b>2) Property</b>		
Kalplaru Pinnacle No. 143	3,84,91,500	3,84,91,500
Kalplaru Pinnacle No. 153	3,84,91,500	3,84,91,500
Kalplaru Pinnacle No. 233	3,84,91,500	3,84,91,500
<b>Total</b>	<b>11,54,87,330</b>	<b>11,54,87,330</b>
<b>Note 11: Long-term loans &amp; advances</b>		
<b>(a) Security Deposit</b>		
	2,76,69,041	2,48,35,854
<b>Total</b>	<b>2,76,69,041</b>	<b>2,48,35,854</b>
<b>Note 12: Trade receivables</b>		
<b>(Unsecured Considered Good)</b>		
Outstanding over six months	-	-
Others	6,38,28,999	12,10,48,989
<b>Total</b>	<b>6,38,28,999</b>	<b>12,10,48,989</b>

Particulars	As at 31st March 2020	As at 31st March 2019
<b>Note 13: Cash and cash equivalents</b>		
(a) Cash On Hand	18,43,360	14,774,00
(b) Balance With Schedule Banks		
(i) In Current A/c	19,63,381	7,01,409
(ii) In Fixed Deposit A/c	9,19,142	8,42,143
<b>Total</b>	<b>47,25,883</b>	<b>17,58,545</b>
<b>Note 14: Short-term loans &amp; advances</b>		
(a) Loans and Advances		
Advances receivable in cash or in kind for the value to be received-Considered Good	4,26,74,374	8,02,38,544
(b) Prepaid Expenses		
(c) Balance with Government Authorities	6,65,26,169	7,04,15,670
<b>Total</b>	<b>10,92,00,543</b>	<b>15,06,54,214</b>
<b>Note 15: Other current assets</b>		
(a) Accruals		
(i) Interest receivable		
<b>Total</b>	<b>-</b>	<b>-</b>
<b>Note 16: Revenue from Operations</b>		
Sale of Services : Aviation Division		
Aviation Passenger Services	-	1,32,53,600
Airport Development & Consultancy	6,63,88,327	1,18,22,034
Other - Operating Subsidiy	-	2,71,75,228
	6,63,88,327	5,22,51,861
Sale of Services : Transport Division		
Goods Transport Services	13,43,53,033	29,14,70,662
	13,43,53,033	29,14,70,662
<b>Total</b>	<b>20,07,41,360</b>	<b>34,37,22,523</b>
<b>Note 17: Other Income</b>		
FDR Interest	1,01,374	1,98,057
Godown Rent	1,97,867	2,02,276
Interest on BG	1,17,993	-
Reimbursement of Expenses (Supreme Airlines)	21,00,000	-
Insurance Refund	1,56,784	-
Other Income	10,17,049	77,203
Profit on sale of vehicle (Net)	1,26,55,583	94,80,981
Profit on sale of Property	-	1,11,24,419
<b>Total</b>	<b>1,63,46,589</b>	<b>2,10,82,836</b>
<b>Note 18: Purchase of Stock in Trade</b>		
<b>Transport Division</b>		
Lorry Hire & Labour Charges	9,15,25,229	11,76,01,849
Petrol & Diesel Expense	26,24,109	8,54,78,739
Loading & Unloading Charges	21,450	11,000
Door Delivery Charges	6,800	4,28,289
Detention Charges	2,70,609	3,99,370
	9,44,48,196	20,39,19,248
<b>Aviation Division</b>		
Aviation Turbine Fuel (ATF)		99,96,014
Custom Duty	2,85,505	
Freight, Customs, Clearing & Forwarding	1,24,268	15,98,295
Counter & Vehicle Rent	3,45,933	38,72,018
Equipments & Spare parts	27,67,550	2,02,68,752
DGCA & AAI Expenses	1,64,800	80,892
Airport Consultancy & Development	-	1,97,985
Aircraft Maintenance	33,01,100	53,55,607
Pilot & Crew Training Expense	24,000	2,13,500
Airport Development Labour Charges	-	1,17,67,380
	70,13,156	5,23,50,443
<b>Total</b>	<b>10,14,61,353</b>	<b>25,62,69,691</b>
<b>Note 19: Employee benefits expenses</b>		
Salaries, wages and bonus	1,72,30,242	3,22,02,002
Contribution to P.F.	1,68,082	2,23,142
ESIC Expenses	28,193	48,932
Service & Retainership	1,05,66,087	1,47,40,051
Director's Remuneration, Bonus, rent & Commission	7,20,000	84,00,000
<b>Total</b>	<b>2,87,12,604</b>	<b>5,56,14,127</b>

Balance sheet 19-20

Particulars	As at 31st March 2020	As at 31st March 2019
<b>Note 20: Finance cost</b>		
Bank Charges		
Interest on Cash Credit	2,11,458	4,26,090
Interest on Secured Term Loans		
Interest On Service Tax		1,25,57,776
Overdue Interest & Charges on Loans		
Penal Interest & Charges		3,30,228
Interest on GST	13,75,850	4,17,783
Interest On TDS Delays		62,660
Interest on Unsecured Loans	1,178	45,898
Interest on Vehicle Loans		
	12,44,241	51,68,474
<b>Total</b>	<b>35,32,677</b>	<b>2,00,78,268</b>

Particulars	As at 31st March 2020	As at 31st March 2019
<b>Note 21: Other expenses</b>		
Advertisement Expenses		32,650
Accident Expense		25,646
Audit Fees	550	2,70,660
Brokerage & Commission Expenses	2,70,660	2,70,660
Business Promotion	1,10,774	6,67,270
Bad Debts	4,12,650	
Claim Expenses	4,97,20,692	75,65,653
Conveyance & Motor Car Expenses	3,621	33,334
GST Penalty	6,37,816	70,44,266
Divul Expense		1,62,406
Party Entertainment Expenses	42,280	93,765
Computer Expense	48,700	39,330
Donation Expenses	47,172	1,60,456
Digital Signature Expense	2,03,526	6,69,152
Electricity Expenses		6,750
Generator Expense	13,85,457	22,33,244
General Charges		4,99,478
GST Late filing fee	9,27,192	18,37,100
VAT - Late filing fee		83,230
CST - Late filing fee		5,000
Prior Period Expense	1,56,503	1,40,100
IGST		7,69,659
Insurance Expenses	40,74,242	78,44,059
GST Labour Cess	1,10,093	
Processing fee		1,39,425
Packing Charges		11,518
Permit Charges		12,10,246
Service Tax	1,39,864	
Legal & Professional Fees	12,30,591	33,35,755
Lodging & Boarding	8,73,093	6,51,138
Membership & Subscription	2,596	
Medical Expense	39,147	4,54,337
Motor Car Expense	2,10,457	70,473
Office & Godown Rent	38,61,744	83,33,210
Office Expenses	30,71,161	33,22,427
Parking Charges	7,56,426	20,31,904
Postage & Courier Expenses	1,21,869	2,88,827
Printing & Stationery Expenses	1,99,404	9,53,762
Other Taxes	36,72,190	73,22,832
Repair & Maintenance Expenses	69,20,803	2,36,80,853
ROC Expenses	14,200	14,230
Staff Welfare Expenses	14,06,682	34,08,684
Security Charges	3,44,725	4,64,554
Society Charges	84,962	1,14,086
Telephone, Internet & Mobile Expenses	12,71,862	24,85,206
Tender Fees	85,710	1,56,786
Way Expense	16,834	
Travelling Expenses	51,14,631	1,04,89,852
<b>Total</b>	<b>8,75,88,989</b>	<b>9,42,78,974</b>

Payment to Auditor	2,70,000	2,70,000
Audit Fee	1,05,000	1,05,000
Professional Fee		

**Note 22: Earnings Per Share (EPS)**

**Basic & Diluted EPS**

Net Profit after tax as per statement of Profit and Loss attributable to Equity Shareholders	(4,85,76,885)	(12,22,38,798)
Weighted Average number of equity shares used as denominator for calculating EPS	70,00,000	70,00,000
	(7)	(17.44)

**Adjusted EPS**

Net Profit after tax as per statement of Profit and Loss attributable to Equity Shareholders	(4,85,76,885)	(12,22,38,798)
Weighted Average number of equity shares used as denominator for calculating EPS	70,00,000	70,00,000
	(7)	(17.44)
	10	10

Face value per equity share

Note 9: Fixed Assets  
 Tangible Assets

Particulars	Rate	Gross Block			Net Book Value			Amount (₹)	
		Opening Balance As on 01/04/2019	Additions	Deletions	Closing Balance as on 31/03/2020	Opening Balance As on 01/04/2019	for the period	Deflation	Closing Balance as on 31/03/2020
Plot at Malegaon	0%	48,817			48,817				48,817
Plot No 3 at Malegaon	0%	1,10,164			1,10,164				1,10,164
Plot No 2 at Pali	0%	59,055			59,055				59,055
Plot No 3 at Pali	0%	1,95,160			1,95,160				1,95,160
Plot at Sonapur	0%	1,15,500			1,15,500				1,15,500
Plot No 41 & 42 AT	0%	1,74,200			1,74,200				1,74,200
Plot at Jajal Baholara	0%	9,32,861			9,32,861				9,32,861
Plot at Panvel	0%	3,19,36,600			3,19,36,600				3,19,36,600
Plot at Shirpur	0%	2,12,165			2,12,165				2,12,165
Plot at Baholara	0%	1,27,500			1,27,500				1,27,500
Plot at datti	0%	2,05,278			2,05,278				2,05,278
Plot at Jaipur	0%	37,000			37,000				37,000
Plot at Kalambooli	0%	3,49,300			3,49,300				3,49,300
Plot No 91 at Pipalaj	0%	26,53,120			26,53,120				26,53,120
Plot No 98 at Pipalaj	0%	26,53,120			26,53,120				26,53,120
Plot at Chennai	0%	14,48,790			14,48,790				14,48,790
Plot at Thakki Ahmednabad	0%	2,66,480			2,66,480				2,66,480
Plot at Bangalore	0%	56,04,041			56,04,041				56,04,041
Vehicle	0%	72,00,000			72,00,000				72,00,000
Trailer MH46F 2459	31.25%	18,43,139			18,43,139	1,42,956			18,43,139
Trailer HRS5P 9028	31.25%	14,91,811			14,91,811	1,15,691			14,91,811
Trailer HRS5P 9030	31.25%	15,57,907			15,57,907	1,20,816			15,57,907
Container 40 Feet	31.25%	3,25,000			3,25,000	3,263			3,25,000
Tractor D401M 7899	31.25%	9,47,403			9,47,403	9,21,815			9,47,403
Tractor G12AU 7899	31.25%	24,15,845			24,15,845	6,072			24,15,845
Tractor G12AU 7999	31.25%	23,34,216			23,34,216	29,103			23,34,216
Tractor G12AU 8499	31.25%	24,15,845			24,15,845	28,119			24,15,845
Tractor Ace	31.25%	3,19,855			3,19,855	3,12,291			3,19,855
Trailer MH06AQ 6002	31.25%	18,79,899			18,79,899	3,12,291			18,79,899
Trailer MH06AQ 6003	31.25%	18,79,899			18,79,899	18,35,446			18,79,899
Trailer MH06AQ 6004	31.25%	21,67,432			21,67,432	18,35,446			21,67,432
Trailer MH06AQ 6005	31.25%	21,67,431			21,67,431	18,35,446			21,67,431
Trailer MH06AQ 6007	31.25%	18,86,249			18,86,249	18,35,446			18,86,249
Trailer MH06AQ 6008	31.25%	18,86,249			18,86,249	18,35,446			18,86,249
Trailer MH06AQ 6009	31.25%	18,86,249			18,86,249	18,35,446			18,86,249
Trailer MH06AQ 6010	31.25%	18,86,249			18,86,249	18,35,446			18,86,249
Trailer MH06AQ 6011	31.25%	18,86,249			18,86,249	18,35,446			18,86,249
Trailer MH06AQ 6012	31.25%	18,86,249			18,86,249	18,35,446			18,86,249
Trailer MH06AQ 6014	31.25%	21,73,782			21,73,782	16,006			21,73,782
Trailer MH06AQ 6015	31.25%	21,73,782			21,73,782	16,006			21,73,782
Trolley No 1 (40 feet)	31.25%	2,90,000			2,90,000	16,053			2,90,000
Trolley No 2 (40 feet)	31.25%	2,90,000			2,90,000	16,053			2,90,000
Trolley DDC	31.25%	8,20,000			8,20,000	2,83,142			8,20,000
Trailer MH46H 555	31.25%	21,97,511			21,97,511	6,056			21,97,511
Trailer MH46H 567	31.25%	21,67,511			21,67,511	14,278			21,67,511
Trailer MH46H 566	31.25%	24,69,825			24,69,825	14,007			24,69,825
Trailer MH46H 678	31.25%	24,39,825			24,39,825	18,239			24,39,825
Trailer MH46H 777	31.25%	24,69,825			24,69,825	23,82,132			24,69,825
Trailer MH46H 786	31.25%	24,55,043			24,55,043	18,018			24,55,043
Trailer MH46H 888	31.25%	21,97,511			21,97,511	18,239			21,97,511
Trailer MH46H 999	31.25%	21,67,511			21,67,511	19,019			21,67,511
Trailer MH46H 2000	31.25%	22,01,919			22,01,919	71,45,547			22,01,919
Trailer MH46H 3000	31.25%	22,15,886			22,15,886	14,228			22,15,886



Godown at Ulhasnagar	63.16%	19,46,980	19,46,980	17,11,569	1,48,486	18,40,264	56,726	2,35,411
Godown at Pakli Ahmedabad	63.16%	6,50,000	6,50,000	5,67,057	52,387	6,19,444	30,556	82,943
Furniture & Fixtures	25.89%	9,49,935	9,49,935	8,08,106	36,720	8,44,825	1,05,110	1,41,829
Furniture & Fixture	25.89%	1,29,881	1,29,881	90,316	10,243	1,00,560	29,321	39,565
Electrical Instruments	25.89%	13,43,473	13,43,473	9,66,915	97,491	10,64,406	2,79,067	3,76,558
CCTV Camera	25.89%	60,598	60,598	57,823	719	58,541	2,057	2,775
Generator & Inverter	25.89%	1,56,884	1,56,884	57,918	33,149	91,067	1,05,817	98,966
Office & Electrical	25.89%	40,000	40,000	33,149	33,149	33,149	33,149	33,149
Telephone Instrument	25.89%	8,53,652	8,53,652	6,85,030	75,998	7,61,028	92,624	1,68,622
Office Equipments	45.07%	8,53,652	8,53,652	6,85,030	75,998	7,61,028	92,624	1,68,622
Air Conditioner	45.07%	8,53,652	8,53,652	6,85,030	75,998	7,61,028	92,624	1,68,622
2010 Cesna Grand Caravan C208B #VT-SAI	13.91%	16,03,35,885	16,03,35,885	4,32,09,485	1,62,92,282	5,95,01,767	10,38,34,118	11,71,26,400
2014 Cesna Grand Caravan C208B #VT-UJN	13.91%	18,37,28,990	18,37,28,990	4,75,58,468	1,89,41,320	6,64,99,797	11,72,29,202	13,61,70,522
Motor Vehicles	31.23%	1,04,85,610	1,04,85,610	74,31,691	9,53,739	83,85,430	21,50,180	30,53,919
Motor Car	31.23%	1,04,85,610	1,04,85,610	74,31,691	9,53,739	83,85,430	21,50,180	30,53,919
Motor Cycles & Scooter	25.89%	16,12,746	16,12,746	11,36,417	1,23,322	12,59,738	3,53,068	4,76,329
Computers	43.16%	24,86,468	24,86,468	24,52,123	45,671	24,97,794	29,066	34,365
Computer Peripheral	43.16%	24,86,468	24,86,468	24,52,123	45,671	24,97,794	29,066	34,365
Total		50,64,54,187	50,64,54,187	25,84,67,077	4,18,98,515	27,91,92,572	28,40,49,544	32,79,87,110
Previous Year		66,07,63,776	66,07,63,776	27,78,61,575	5,39,50,190	31,81,05,169	32,79,87,110	38,29,02,201



# SUPREME TRANSPORT ORGANISATION PVT LTD

AN ISO 9001, 2008 COMPANY CIN NO U60230MH2008PTC216143 MSME REGD NO 27222200461  
Regd Off 5 B 34 Akshay Mittal Industrial Estate M V Road Andheri East Mumbai 400 059  
Tel +91 22 4238 3904 05 06 07 Fax +91 22 42383945  
Email mumbai@stoptl.in Website www.stoptl.in

03<sup>rd</sup> September, 2020

To,

C P Patel & Associates,  
Chartered Accountants,  
A-702,JVM Olive,Bhayanderpada,  
Near Lodha Splendor. Thane west -400615.

Dear Sir,

Re: Audit for the year ended 31<sup>st</sup> March 2020

This representation letter is provided in connection with your audit of the financial statements of M/s SUPREME TRANSPORT ORGANISATION PVT LTD for the year ended 31<sup>st</sup> March 2020 for the purpose of expressing an opinion as to whether the financial statements give a true and fair view of the financial position of SUPREME TRANSPORT ORGANISATION PVT LTD as of 31<sup>st</sup> March 2020 and of the results of operations for the year then ended.

We acknowledged our responsibility for preparation of financial statements in accordance with the requirements of the Companies Act, 2013 and recognized accounting policies and practices, including the Accounting Standards issued by the Institute of Chartered Accountants of India wherever applicable.

We confirm, to the best of our knowledge and belief, the following representations or other relevant statue.

## **ACCOUNTING POLICIES**

1. The financial statements have been prepared under the Historical Cost Convention on the basis of a going concern and in accordance with the Accounting Standards notified under The Companies Act' 2013 / The Institute of Chartered Accountants of India, wherever applicable.
2. The accounting policies which are material or critical in determining the results of operations for the year or financial position are set out in the financial statements and are consistent with those adopted in the financial statements for the previous year. The financial statements are prepared on accrual basis unless otherwise stated.

### ASSETS

3. The Company has a satisfactory title to all assets and there are no liens or encumbrances on the Company's assets, except for those that are disclosed in Notes on Accounts to the financial statements.

### FIXED ASSETS

4. The net book values at which fixed assets are stated in the balance sheet are arrived at:
- after taking into account all capital expenditure on additions thereto, but no expenditure properly chargeable to revenue;
  - after eliminating the cost and accumulated depreciation relating to items sold, discarded, demolished or destroyed;
  - After providing adequate depreciation on fixed assets during the period.
  - Depreciation on fixed assets is provided on the Written Down Value method at the rates prescribed in the Schedule II of the Companies Act 2013 on a pro rata basis for assets purchased/sold.
  - None of the fixed assets have been revalued during the year.
  - Physical verification is carried out based on a phased program of verifying all the assets over a period of three years.
  - We have physically verified the fixed assets of the company during the year and no material discrepancies have been found on such verification.
  - The details of additions to Fixed Assets and the date on which the same were put to use is detailed as below :

Sl No	Assets Details	Value of Assets (Rs.)	Date of Purchase / Put to use
1	Computer Peripheral	40372	23th April, 2019
2	Mobile	40000	10th July, 2019

- i) Also company had sold 15 Vehicles having WDV of 2,32,92,422/- for Rs 3,59,48,005/- resulting in net gain of Rs. 1,26,55,583/-.

### CAPITAL COMMITMENTS

5. At the balance sheet date, there were no outstanding commitments for capital expenditure

## INVESTMENTS

6. The investments shown in the balance sheet are 'long-term investments' & 'Current Investments'
7. Long-term investments have been valued at cost, except that any permanent diminution in their carrying amount.
8. All the investment produced to you for physical verification belongs to the company and they do not include any investment held on behalf of other person.
9. The entity has clear title to all its investments including such investments which are in the process of being registered in the name of the entity or which are not held in the name of the company and there are no charges against the investment of the company.

## INVENTORIES

10. The company does not carry any inventory.

## DEBTORS, LOANS AND ADVANCES

11. The items appearing in the books as a recoverable debtors, Loans and Advances are written off bad debts to the tune of Rs 1,27,22,621/- are written off bad debts to the tune of Rs 4,70,000/-.
12. In the opinion of the Board of Directors, investments have a value on realization in the ordinary course of the company's business which is not different from amount at which stated in the Balance Sheet.
13. The company has recognized an amount to the tune of Rs 54,738,644/- consisting of following: -
  - a. Rent receivable from following for unauthorized usage of Company properties by them: -

Name
Mr. Ravindra Agarwal
Mr. Anand Agarwal

The company has handed over the properties to Kotak Mahindra Bank and the flats stand vacated out of which 2 are already sold.

- b. Unauthorized transfer from company's

Name
Mr. Satish Agarwal
Mr. Anand Agarwal
Mr. Arun Agarwal

- a. Unauthorized withdrawal from company's

Name
Mr. Ravindra Agarwal
Mr. Anand Agarwal
Mr. Satish Agarwal
Mr. Arun Agarwal

March 2020 are considered good and fully recoverable. However, proceedings against some debtors are pending at NCLT. Moreover, the company has recognized an amount to the tune of Rs 4,70,000/-.

Investments other than Fixed assets and Non-current investments are in the ordinary course of the company's business which are stated in the Balance Sheet.

The amount of Rs 54,738,644/- consisting of following: -

Amount of Rent Receivable
Rs 3,600,000
Rs 3,600,000

The properties are to Kotak Mahindra Bank and the flats stand vacated.

Unauthorized transfers from company's account directly to their account by following: -

Amount (Rs.)
Rs. 7,123,731
Rs. 14,123,731
Rs. 7,123,731

Unauthorized withdrawals from company's account directly to their account by following: -

Amount (Rs.)
Rs. 14,163,417
Rs. 1,145,203
Rs. 1,282,105
Rs. 2,576,726

- h. Mr. Sarish Agarwal, Mr. Anand Agarwal, Mr. Ravindra Agarwal and Mr. Arun Agarwal for its unauthorized withdrawal. The legal proceedings are initiated and are pending at appropriate forums.

#### **LIABILITIES**

- c. We have recorded all known liabilities in the financial statements.
- d. No guarantees have been to third parties.
- e. Contingent liabilities disclosed in the notes to the financial statements do not include any contingencies which are likely to result in a loss and which, therefore, require adjustment of assets or liabilities
- f. A liability is classified as current when it satisfies the following criteria:
  - a. It is expected to be settled in the company's normal operating cycle.
  - b. It is held primarily for the purpose of being traded
  - c. It is due to be settled within 12 months after the reporting date; or
  - d. The company does not have an unconditional right to defer the settlement of liability for more than 12 months after the reporting date

Current liabilities include current portion of non-current financial liabilities

- g. In the opinion of the management, and to the extent of information available from the Company's records there are no amounts payable to the small-scale industries as at 31st March 2020.
- h. The company has given 3 properties for auction to Kotak Mahindra bank on which there are term loans outstanding from Kotak Mahindra Bank. The same will be paid off on sale of these fixed assets or on receipt from customers. However, Kotak Mahindra Bank has sold off the two properties namely flat no 143 and Flat No 223 without proper procedures. The company has defaulted on loans for HDFC Bank, Tata Motors Finance Limited, Indus Ind Bank The company plans to regularize the loans on recovery of dues from customers.

#### **PROVISIONS FOR CLAIMS AND LOSSES**

- i. Claims of whatsoever nature are accounted for on cash basis.
- j. There have been no events subsequent to the balance sheet date which require adjustment of, or disclosure in, the financial statements or notes thereto

#### **STATEMENT OF PROFIT AND LOSS**

- k. Except as disclosed in the financial statements, the results for the year were not materially affected by:
  - i. transactions of a nature not usually undertaken by the company;
  - ii. circumstances of an exceptional or non-recurring nature;
  - iii. charges or credits relating to prior years;
  - iv. changes in accounting policies.

#### **GENERAL**

- l. There have been no irregularities involving management or employees who have a significant role in the system of internal control that could have a material effect on the financial statements.
- m. The financial statements are free of material misstatements, including omissions.

- ii. The company has complied with all aspects of contractual agreements that could have a material effect on the financial statements in the event of non-compliance. There has been no non-compliance with requirements of regulatory authorities that could have a material effect on the financial statements in the event of non-compliance.
- o. We have complied with all the relevant provisions of statute as applicable to us and our records and minutes in this respect are up-to-date and are open for inspection in the course of your audit.
- p. On the basis of written representations received from the directors as on March 31, 2020, and taken on record by the Board of Directors, none of the directors is disqualified as on March 31, 2020, from being appointed as a director in terms of Section 164(2) of the Act.
- q. We have no plans or intentions that may materially affect the carrying value or classification of assets and liabilities reflected in the financial statements.
- r. No personal expenses of employees and directors have been charged to the revenue account, other than those payable under contractual obligation or in accordance with generally accepted business practices.
- s. The company has granted and taken unsecured loans to and from companies covered in the register maintained under section 189 of the Companies Act, 2013 in compliance with the provisions of section 188 of the companies act, 2013. However, the company has given temporary given loan to director to the tune of Rs 19,30,000/- in contravention to section 185 for exigency purpose.
- t. Details of contracts or arrangements that need to be entered in the register maintained under section 109 of the Companies Act, 2013 have been so entered.
- u. The company does not have a formal Internal Audit System.
- v. None of the directors are disqualified under section 164 of the Companies Act, 2013.
- w. The related parties as per Accounting Standard – 18 of Related parties are as given below:

**Related Parties:**

**a) Key Management Personnel**

Sr. No.	Name of the person	Relationship
1	Kamal Agarwal	Director
2	Ammeet Agarwal	Director
3	Akkash Agarwal	Director
4	Vimal Agarwal	Director
5	Girish Agarwal	Director

**b) Relatives Key Management Personnel**

Sr. No.	Name of the person	Relationship
1	Sangeeta Agarwal	Wife of Director
2	Samiksha Agarwal	Wife of Director
3	Nupur Agarwal	Wife of Director
4	Pinky Agarwal	Sister of Director

The company has complied with provisions of section 188 in respect of transactions with related parties.

Details transactions with related parties are disclosed in Note No. 28 to the Financial Statements.

All the related parties transactions are entered in the ordinary course of business at arm's length basis.

- x. The company has not accepted any deposits from public during the year.
- y. The Company has been regular in depositing undisputed statutory dues, including Income-tax and any other material statutory dues with the appropriate authorities during the period. There are no undisputed statutory demands outstanding as on balance sheet date for a period exceeding six months.
- z. The company has availed term loan in previous year for purchase of fixed assets.
- aa. There has been no fraud on or by the Company was noticed or reported during the period.
- bb. The cash balance in hand as on 31<sup>st</sup> March 2020 was Rs 18,43,360/-

**TAX AUDIT:**

- cc. All the loans or deposit or repayment thereof was made by account payee cheques or demand draft only.
- dd. We have complied with Income Tax provisions in respect of deduction of TDS.
- ee. All the payments in respect of any revenue item has been made in compliance with the provisions of Section 40(A)(3) of the Income Tax Act'1961.
- ff. Our Books of Accounts and Other Records are kept at our address as mentioned above.

We are enclosing herewith the financial statements duly approved by the Board of Directors for your report thereon.

Thanking you

Yours faithfully,

**For, Supreme Transport Organisation Private Limited.**



**Shri Kamal Agarwal**

**Chairman & Managing Director**

**(DIN: 1252090)**



## Note 1: Significant Accounting Policies

### 1.1 Basis of preparation of Financial Statements

#### **(a) Basis of Accounting:**

These financial statements have been prepared in accordance with the Indian Accounting Standards (hereinafter referred to as the 'Ind AS'), as notified by Ministry of Corporate Affairs pursuant to Section 133 of the Companies Act, 2013 ('Act') read with the Companies (Indian Accounting Standards) Rules, 2015 as amended and other relevant provisions of the Act. The financial statements have been prepared on a historical cost convention.

All assets and liabilities have been classified as current or non-current as per the Company's normal operating cycle (twelve months) and other criteria set out in the Schedule III to the Act.

The said estimates are based on the facts and events, that existed as at the reporting date, or that occurred after that date but provide additional evidence about conditions existing as at the reporting date.

#### **(b) Use of Estimates:**

The preparation of Financial Statements requires estimates and assumptions to be made that affect the reported amount of assets & liabilities on the date of Financial Statements and the reported amount of revenues & expenses during the related period. Difference between the actual results and estimates are recognized in the period in which the results are known/ materialized.

### 1.2 Fixed Assets

Fixed Assets are stated at Cost less Depreciation.

### 1.3 Depreciation

Depreciation has been provided on the Fixed Assets at the rate and mode specified by the Schedule - II to the Companies Act, 2013 on written down value method on pro-rata basis.

### 1.4. Impairment of Assets

Current Assets have a value on realization in the ordinary course of company's business, which is at least equal to the amount at which they are stated in the Balance sheet except as stated in the financial statements.

### 1.5 Inventories

#### **a) Raw Materials:**

The company is in the business of providing transportation services and is mainly divided into 2 segments:

- a. Transport Division - It does not have any raw material as it is a service industry
- b. Aviation Division - It does not have any raw material as it is a service industry

### 1.6 Investments

Investments are carried at cost. Provision for diminution in the value of investments is made only if such a decline is other than temporary in the opinion of the management.

### 1.7 Revenue Recognition

Revenue is recognized to the extent that it is probable that the economic benefits will flow to the company and can be reliably measure.

Interest income is recognized on a time proportion basis taking in to account the amount outstanding and applicable interest rate.

Receipts from subsidies are recorded on receipt basis

Dividend income on Investments is accounted for when the right to receive the payment is established.

### 1.8 Prior Period and Extra Ordinary Items

Items of Income and Expenditure pertaining to Prior Period as well as Extra Ordinary Items, where material, are disclosed separately.

### 1.9 Provision for Current and Deferred Tax

Current tax is determined as the amount of tax payable in respect of taxable income for the year.

Deferred tax is recognized, on timing difference, being the difference between taxable income and accounting income that originate in one period and are capable of reversal in one or more subsequent periods.

Where there is unabsorbed depreciation or carry forward losses, deferred tax assets are recognized if there is virtual certainty that sufficient future taxable income will be available against which such assets can be realized. Other deferred tax assets are recognized only to the extent there is reasonable certainty of realization in future. Such assets are reviewed at each Balance Sheet date on reassess realization.

Deferred tax assets and liabilities are measured using the tax rates and tax laws that have been enacted or substantively enacted by the balance-sheet date.

### 1.10 Foreign Currency Transactions

Transactions in foreign currency are initially recorded at exchange rate prevailing on the date of transaction. At each balance-sheet date monetary items denominated in foreign currency are translated at the exchange rate prevailing on the Balance Sheet date.

Any Income or Expense on account of exchange difference either on settlement or on translation is recognized in Statement of Profit and Loss.

### 1.11 Contingent Liabilities and Contingent Assets

Provision is recognized in the accounts when there is a present obligation as a result of past event(s) and it is probable that an outflow of resources will be required to settle the obligation and reliable estimate can be made. Provisions are not discounted to their present value and are determined based on the best estimate required to settle the obligation at the reporting date. These estimates are reviewed at each reporting date and adjusted to reflect the current best estimates. Contingent liabilities are disclosed unless the possibility of outflow of resources are remote. Contingent assets are neither recognized and nor disclosed in the financial statements.

### 1.12 Employee Benefits

The company has not provided or form any provision in the form of retirement benefit during the year. Retirement Benefits are provided to employee at the time of retirement. Short term employee benefits are recognized as an expense in the profit and loss account for the year in which the related service is rendered. Payment of Gratuity is made at the time of retirement of employee.

### 1.13 Cash Flow Statements

Cash Flow statements are reported using Indirect method, whereby net profit before tax is adjusted for the effect of transactions of a non cash nature, any deferral of accruals of past or future operating cash receipts or payments and Item of income or expense associated with investing or financing cash flows. The Cash flow from operating, investing and financing activities of the company are segregated.

### 1.14 Earnings Per Share

The Basic and Diluted Earnings Per Share ("EPS") is computed by dividing the net profit after tax for the year by weighted average number of equity shares outstanding during the year.

# Supreme Transport Organisation Pvt. Ltd.

CIN: U60230MH2008PTC216143

Notes forming part of Financial Statements for the year ended on 31/03/2020

## Note 23: Additional Disclosure

1. Freight Income are registered on accrual systems under bulk booking and on cash system under loose booking. All the direct and indirect expenses are accounted on accrual basis except telephone, mobile & electricity expenses which have been accounted on payment basis.
2. In the opinion of the management the current assets loans & advances and sundry debtors are approximately of the value stated if realized in the ordinary course of business. However, in respect of sundry debtors; dues to the tune of Rs 1,27,22,621/- are subject to litigation and cases are pending at NCLT.
3. Closing balance of sundry debtors, sundry creditors and deposit accounts are subject to confirmation and are taken as per books of accounts.
4. All the expenditure covered under section 40A (3) and section 40A(3A) read with rule 6DD which have not been verified due to non-availability /possession of necessary evidence by the company
5. The secured loan balances from IIFL, Shriram Transport Finance Company Limited, HDFC Bank and Indusind Bank are subject to balance confirmation from banks and are taken as per books of accounts. Kotak Mahindra Bank had initiated auction of 3 flats against which it had disbursed loan. As per DRT order dated. 15-02-2019 the claim settlement amount is Rs. 20 crores. The Company has partly paid the outstanding amount of the loan and still Rs. 4.80 crores are pending to be paid. However, Kotak Mahindra bank in its Cash Credit Account continues to charge interest which has not been considered in books as the settlement order has come from DRT.

However, the bank has sold off 2 of the properties (Property No. 143 and Property No. 223) to recover the loans and company has not accepted the same and filed a suit against the bank for unauthorized sale. Hence the said properties are still appearing in the books.

6. An amount to the tune of Rs 54,738,644/- consisting of following: -
  - a. Rent receivable from following for unauthorized usage of Company properties by them: -

Name	Amount of Rent Receivable
Mr. Ravindra Agarwal	Rs 3,600,000
Mr. Anand Agarwal	Rs 3,600,000

The company has handed over the properties to Kotak Mahindra Bank as discussed in point no5, and the flats stand vacated out of which 2 are already sold.

- b. Unauthorized transfer from company's account directly to their account by following: -

Name	Amount (Rs.)
Mr. Satish Agarwal	Rs. 7,123,731
Mr. Anand Agarwal	Rs. 14,123,731
Mr. Arun Agarwal	Rs. 7,123,731

- c. Unauthorized withdrawal from company's account directly to their account by following: -

Name	Amount (Rs.)
Mr. Ravindra Agarwal	Rs. 14,163,417
Mr. Anand Agarwal	Rs. 1,145,203
Mr. Satish Agarwal	Rs. 1,282,105
Mr. Arun Agarwal	Rs. 2,576,726

7. The company has granted and taken unsecured loans to and from companies covered in the register maintained under section 189 of the Companies Act, 2013 in compliance with the provisions of section 188 of the companies act, 2013. However, the company has given temporary given loan to director to the tune of Rs 19,30,000/- in contravention to section 185 for exigency purpose.

F.Y. 2019-20

Supreme Transport Organisation Pvt. Ltd.

CIN: U60230MH2008PTC216143

Notes forming part of Financial Statements for the year ended on 31/03/2020

**Note 24: Related Party Transactions:**

**Related Parties:**

**a) Key Management Personnel**

Sr. No.	Name of the person	Relationship
1	Kamal Agarwal	Director
2	Ammeet Agarwal	Director
3	Akkash Agarwal	Director
4	Vimal Agarwal	Director
5	Girish Agarwal	Director

**b) Relatives Key Management Personnel**

Sr. No.	Name of the person	Relationship
1	Sangeeta Agarwal	Wife of Director
2	Samiksha Agarwal	Wife of Director
3	Nupur Agarwal	Wife of Director
4	Pinky Agarwal	Sister of Director

**Disclosure of transactions with Related Parties:**

**a) Transaction with Key managerial Personnel**

Sr. No.	Name of the person	Relationship	Amount (Rs)
<b>I) Payment of Rent to Directors</b>			
1	Vimal Agarwal	Director	2,40,000
2	Girish Agarwal	Director	2,40,000

**b) Transactions with Relatives of Key managerial Personnel**

Sr. No.	Name of the person	Relationship	Amount (Rs)
<b>I) Payment of Salary</b>			
3	Nupur Agarwal	Wife of Director	4,80,000
4	Samiksha Agarwal	Wife of Director	5,40,000
5	Pinky Agarwal	Sister of Director	5,40,000
<b>II) Payment of rent:</b>			
1	Nupur Agarwal	Wife of Director	2,40,000

**Note 25: Deferred Tax**

Particulars	2019-20	2018-19
Opening Balance of deferred Tax Liability	6,04,40,227	5,35,87,319
Add: Provision Made during the year	22,97,928	68,52,907
Closing Balance of deferred Tax Liability	6,27,38,155	6,04,40,227

F.Y. 2019-20

**Supreme Transport Organisation Pvt. Ltd.**

CIN: U60230MH2008PTC216143

Notes forming part of Financial Statements for the year ended on 31/03/2020

**Note 26:**

Debit and credit balance relating to various parties are subject to confirmation.

**Note 27:**

Previous years' figures have been regrouped / rearranged, wherever necessary in order to make them comparable with that of current financial year.

**Note 28:**

The company does not have complete information to determine small & ancillary industrial supplier of the company and so has not been shown the amount due to small & ancillary industries.

**Signatures to Notes 1 to 28 of Financial Statements**

As per our Report of even date

For, C P Patel & Associates  
Chartered Accountants  
F.R.N.142609W

*CP Patel*

Chirag Patel  
Proprietor  
Membership No. 128407  
UDIN: 21128407AAAAAE8002

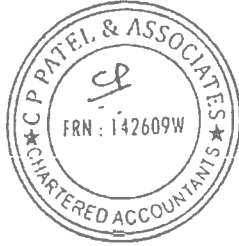

For and on behalf of the Board

*Kamal Agarwal*  
Shri Kamal Agarwal  
Chairman & Managing Director  
DIN: 1252090

*Ammeet K Agarwal*  
H.E. Captain Ammeet K Agarwal  
Director  
DIN: 05293676

Date: 23-12-2020  
Place: Mumbai

Date: 23-12-2020  
Place: Mumbai



## INDEPENDENT AUDITOR'S REPORT

TO THE MEMBERS OF  
SUPREME TRANSPORT ORGANISATION PRIVATE LIMITED

### Report on the financial Statements

We have audited the accompanying financial statements of **SUPREME TRANSPORT ORGANISATION PRIVATE LIMITED** which comprises the Balance sheet as at **March 31<sup>st</sup>, 2021**. The statement of Profit and Loss and Cash Flow Statement for the year then ended, and a summary of significant accounting policies and other explanatory information.

#### Opinion

In our opinion and to the best of our information and according to the explanations given to us, the aforesaid financial statements give the information required by the Companies Act, 2013 ("the Act") in the manner so required and give a true and fair view in conformity with the Indian Accounting Standards prescribed under section 133 of the Act read with the Companies (Indian Accounting Standards) Rules, 2015, as amended. ("Ind AS") and other accounting principles generally accepted in India, of the state of affairs of the Company as at March 31, 2021, and its cash flows for the year ended on that date except for the matters referred in emphasis of matter.

#### Basis of Opinion

We conducted our audit of financial statements in accordance with the Standards on Auditing specified under section 143(10) of the Act (SAs). Our responsibilities under those standards are further described in the Auditor's Responsibilities for the Audit of the Financial Statements section of our report. We are independent of the Company in accordance with the Code of Ethics issued by the Institute of Chartered Accountants of India (ICAI) together with the independence requirements that are relevant to our audit of the financial statements under the provisions of the Act and the Rules made thereunder, and we have fulfilled our other ethical responsibilities in accordance with these requirements and the ICAI's Code of Ethics. We believe that the audit evidence we have obtained is sufficient and appropriate provide a basis for our audit opinion on the financial statements.



**AURANGABAD (HEAD OFFICE) :**  
315, 3rd Floor, Sai Trade Center, Near Mayor Bunglow  
Gating Road, Aurangabad, 431001

**PUNE (BRANCH OFFICE) :**  
Flat No.12, 4th Floor, Butte Patil Tower,  
Ganive Chowk. LBS Road. Sadashiv Path. Pune-411030

### **Emphasis Of Matter**

We invite attention to:

1. The Notes regarding loans; the closing balances of all loans are not yet confirmed by the balance confirmation from banks/FI's. It also states the ongoing litigation between Kotak Bank and STOPL and Axis Bank and STOPL. Both these loans are under SARFAESI as on date.

The closing balance of loans does not reflect penal interest portion on the loans which the company has not accepted.

As described in Notes forming part of financial statement, Company has calculated closing balance as per the books considering repayment made as per bank statements as on March 31, 2021 in respect of loans from Kotak Bank, IndusInd Bank, Shriram Transport Finance Limited, Indostar, Axis bank due to non-availability of closing balance confirmation from banks as on the date of signing of audit report.

The Statement of Account provided by banks does not give clarity regarding the closing balances as on March 31, 2021. Moreover, Company does not agree with charging of penal interest by banks as Company wants to handover possession of assets to banks against the loans. There are litigations going on in respect of Term Loans and CC of Kotak Mahindra Bank and Aircraft loan of Axis Bank for settlement of loans. Also, Kotak Mahindra Bank has sold off Flat no 143 and Flat no 233 which were sold off for recovery of loans against those properties under the SARFAESI Act, 2002. However, company has objected to this selling due to improper auction procedure and the same is in litigation. In view of the lack of clarity in terms of settlement the said properties have been still shown in books as also the loan outstanding for which these properties were mortgaged. So, in absence of sufficient and appropriate evidence we are unable to comment on the exact closing balance of Loans and the possible impact of the Interest on the profitability of financial statements as on March 31, 2021.

With reference to additional disclosure in Notes, regarding the balance of Sundry Creditors, Debtors, Loans and Advances, deposits not confirmed by the parties and hence our inability to state whether these balances are recoverable/payable to the extent stated.

2. The Company has given advances to directors violating the provision of section 185 of the Companies Act, 2013



## **Information Other than the Financial Statements and Auditor's Report Thereon**

The Company's Management is responsible for the preparation of the other information. The information comprises the information included in the Board's Report including Annexure to Board's Report, Management Discussion and Analysis/ Business Responsibility Report/Corporate Governance and Shareholder's Information, but does not include the financial statements and our auditor's report thereon. The above-referred information is expected to be made available to us after the date of this audit report.

Our opinion on the financial statements does not cover the other information and we do not express any form of assurance conclusion thereon.

In connection with our audit of the financial statements, our responsibility is to read the other information identified above when it becomes available and, in doing so, consider whether the other information is materially inconsistent with the financial statements or our knowledge obtained during the course of our audit or otherwise appears to be materially misstated. If, based on the work we have performed, we conclude that there is a material misstatement of this other information; we are required to report that fact.

When we read the other information, if we conclude that there is a material misstatement therein, we are required to communicate the matter to those charged with governance and take appropriate actions necessitated by the circumstances and the applicable laws and regulations.

## **Responsibilities of Management and Those Charged with Governance for the Financial Statements**

The Company's management is responsible for the matters stated in Section 134(5) of the Companies Act, 2013 ("the Act") with respect to the preparation of these financial statements that give a true & fair view of the financial position, financial performance, changes in equity and cash flows of the Company in accordance with the accounting principles generally accepted in India, including the Accounting Standards specified under Section 133 of the Act, read with Rule 7 of the Companies (Accounts) Rules, 2004. This responsibility also includes maintenance of adequate accounting records in accordance with the provisions of the Act for safeguarding of the assets of the Company and for preventing and detecting frauds and other irregularities; selection and application of appropriate accounting policies; making judgments and estimates that are reasonable and prudent; and design, implementation and maintenance of adequate internal financial controls, that were operating effectively for ensuring the accuracy and completeness of the accounting records, relevant to the preparation and presentation of the financial statements that give a true and fair view and are free from material misstatement, whether due to fraud or error.

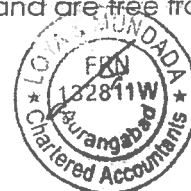

In preparing the financial statements, management is responsible for assessing the Company's ability to continue as a going concern. The Management is responsible for overseeing the Company's financial reporting process.

### **Auditor's Responsibility for the Audit of the Financial Statements**

Our objectives are to obtain reasonable assurance about whether the financial statements as a whole are free from material misstatement, whether due to fraud or error, and to issue an auditor's report that includes our opinion. Reasonable assurance is a high level of assurance, but is not a guarantee that an audit conducted in accordance with SAs will always detect a material misstatement when it exists. Misstatements can arise from fraud or error and are considered material if, individually or in the aggregate, they could reasonably be expected to influence the economic decisions of users taken on the basis of these financial statements.

As part of an audit in accordance with SAs, we exercise professional judgment and maintain professional skepticism throughout the audit. We also:

- Identify and assess the risks of material misstatement of the financial statements, whether due to fraud or error, design and perform audit procedures responsive to those risks, and obtain audit evidence that is sufficient and appropriate to provide a basis for our opinion. The risk of not detecting a material misstatement resulting from fraud is higher than for one resulting from error, as fraud may involve collusion, forgery, intentional omissions, misrepresentations, or the override of internal control.
- Obtain an understanding of internal financial controls relevant to the audit in order to design audit procedures that are appropriate in the circumstances. Under section \ 43(3) (1) of the Act, we are also responsible for expressing our opinion on whether the Company has adequate internal financial controls system in place and the operating effectiveness of such controls
- Evaluate the appropriateness of accounting policies used and the reasonableness of accounting estimates and related disclosures made by management.
- Conclude on the appropriateness of management's use of the going concern basis of accounting and, based on the audit evidence obtained, whether a material uncertainty exists related to events or conditions that may cast significant doubt on the Company's ability to continue as a going concern. If we conclude that a material uncertainty exists, we are required to draw attention in our auditor's report to the related disclosures in the financial statements or, if such disclosures are inadequate, to modify our opinion. Our conclusions are based on the audit evidence obtained up to the date of our auditor's report. However, future events or conditions may cause the Company to cease to continue as a going concern.
- Evaluate the overall presentation, structure and content of the financial statements,



including the disclosures, and whether the financial statements represent the underlying transactions and events in a manner that achieves fair presentation.

Materiality is the magnitude of misstatements in the financial statements that, individually or in aggregate, makes it probable that the economic decisions of a reasonably knowledgeable user of the financial statements may be influenced. We consider quantitative materiality and qualitative factors. in (i) planning the scope of our audit work and in evaluating the results of our work; and (ii) to evaluate the effect of any identified misstatements in the financial statements.

We communicate with those charged with governance regarding, among other matters, the planned scope and timing of the audit and significant audit findings, including any significant deficiencies in internal control that we identify during our audit.

We also provide those charged with governance with a statement that we have complied with relevant ethical requirements regarding independence, and to communicate with them all relationships and other matters that may reasonably be thought to bear on our independence, and where applicable, related safeguards.

From the matters communicated with those charged with governance, we determine those matters that were of most significance in the audit of the financial statements of the current period and are therefore the key audit matters. We describe these matters in our auditor's report

unless law or regulation precludes public disclosure about the matter or when, in extremely rare circumstances, we determine that a matter should not be communicated in our report because the adverse consequences of doing so would reasonably be expected to outweigh the public interest benefits of such communication

### **Report on Other Legal and Regulatory Requirements**

1. As required by Section 143(3) of the Act, based on our audit we report that:
  - a) We have sought and obtained all the information and explanations which to the best of our knowledge and belief were necessary for the purposes of our audit.
  - b) In our opinion proper books of account as required by law have been kept by the Company so far as appears from our examination of those books.
  - c) The Balance Sheet and the Statement of Profit and Loss including the Statement of Cash Flow dealt with by this Report are in agreement with the books of account.
  - d) In our opinion, the aforesaid financial statements comply with the Accounting Standards specified under Section 133 of the Act, read with Rule 7 of the Companies (Accounts) Rules, 2014.



- e) On the basis of the written representations received from the directors as on 31st March, 2021 taken on record by the Board of Directors, none of the directors is disqualified as on 31st March, 2021 from being appointed as a director in terms of Section 164 (2) of the Act.
- f) With respect to the adequacy of the internal financial controls with reference to financial statements of the Company and the operating effectiveness of such controls, refer to our separate Report in "Annexure A". Our report expresses an unmodified opinion on the adequacy and operating effectiveness of the Company's Internal Financial Controls with reference to financial statements.
- g) With respect to the other matters included in the Auditor's Report in accordance with Rule 11 of the companies (Audit and Auditors) Rule, 2014, in our opinion and to the best of our information and according to the explanation given to us and to best of our information and according to the explanations given to Us:
- The company has disclosed the impact of pending litigation on its financial position in its financial statements;
  - The Company did not have any long-term contracts including derivative contracts for which there were any material foreseeable losses;
  - There has been no delay in transferring amounts, required to be transferred. to the Investor Education and Protection Fund by the Company.

2. As required by the Companies (Auditor's Report) Order, 2016 ("the Order"). issued by the Central Government of India in terms of sub-section 11) of Section 143 of the Act. we give in "Annexure B a statement on the matters specified in paragraphs 3 and 4 Of the Order.

**For LOYA AND MUNDADA**  
**Chartered Accountants**  
Firm Registration Number. 132811W

  
**CA Girish G Mundada**  
**Partner**  
Membership Number.141172  
Mumbai  
30/11/2021



## **ANNEXURE "A" TO THE INDEPENDENT AUDITOR'S REPORT**

(Referred to in paragraph 1(f) under 'Report on Other Legal and Regulatory Requirements' section of our report to the Members of Supreme Transport Organisation Private Limited of even date)

Report on the Internal Financial Controls with reference to Financial Statements under Clause (i) of Sub- section 3 of section 143 of the Companies Act, 2013 ("the Act")

We have audited the Internal Financial Controls with reference to financial statements of SUPREME TRANSPORT ORGANISATION PRIVATE LIMITED ("the Company") as of March 31, 2021 in conjunction with our audit of the financial statements of the Company for the year ended on that date.

### **Management's Responsibility for Internal Financial Controls**

The Management of the company is responsible for establishing and maintaining internal financial control based on the internal control over financial reporting criteria established by the Company considering the essential components of internal control stated in the Guidance Note on Audit of Internal Financial Controls with reference to financial statements issued by the Institute of Chartered Accountants of India ("ICAI"). These responsibilities include the design, implementation and maintenance of adequate internal financial controls that were operating effectively for ensuring the orderly and efficient conduct of its business, including adherence to company's policies, the safeguarding of its assets, the prevention and detection of frauds and errors, the accuracy and completeness of the accounting records, and the timely preparation of reliable financial information, as required under the Companies Act, 2013.

### **Auditors' Responsibility**

Our responsibility is to express an opinion on the Company's Internal Financial Controls with reference to financial statements based on our audit. We conducted our audit in accordance with the Guidance Note on Audit of Internal Financial Controls with reference to financial statements (the "Guidance Note") issued by the Institute of Chartered Accountants of India and the Standards on Auditing, issued by ICAI and deemed to be prescribed under section 143(10) of the Companies Act, 2013, to the extent applicable to an audit of internal financial controls, both issued by the Institute of



Chartered Accountants of India. Those Standards and the Guidance Note require that we comply with ethical requirements and plan and perform the to obtain reasonable assurance about whether adequate Internal Financial Controls with reference to financial statements was established and maintained and if such controls operated effectively in all material respects.

Our audit involves performing procedures to obtain audit evidence about the adequacy of the Internal Financial Controls with reference to financial statements and their operating effectiveness. Our audit of Internal Financial Controls with reference to financial statements included obtaining an understanding of Internal Financial Controls with reference to financial statements, assessing the risk that a material weakness exists, and testing and evaluating the design and operating effectiveness of internal control based on the assessed risk. The procedures selected depend on the auditor's judgment, including the assessment of the risks of material misstatement of the financial statements, whether due to fraud or error.

We believe that the audit evidence we have obtained is sufficient and appropriate to provide a basis for our audit opinion on the Company's Internal Financial Controls with reference to financial statements.

### **Meaning of Internal Financial Controls with reference to financial statements**

A company's Internal Financial Controls with reference to financial statements is a process designed to provide reasonable assurance regarding the reliability of financial reporting and the preparation of financial statements for external purposes in accordance with generally accepted accounting principles. A company's Internal Financial Controls with reference to financial statements includes those policies and procedures that

- (1) pertain to the maintenance of records that, in reasonable detail, accurately and fairly reflect the transactions and dispositions of the assets of the company;
- (2) provide reasonable assurance that transactions are recorded as necessary to permit preparation of financial statements in accordance with generally accepted accounting principles, and that receipts and expenditures of the company are being made only in accordance with authorizations of management and directors of the company; and
- (3) provide reasonable assurance regarding prevention or timely detection of unauthorized acquisition, use, or disposition of the company's assets that could have a material effect on the financial statements.



## **Inherent Limitations of Internal Financial Controls with reference to financial statements**

Because of the inherent limitations of Internal Financial Controls with reference to financial statements, including the possibility of collusion or improper management override of controls, material misstatements due to error or fraud may occur and not be detected. Also, projections of any evaluation of the Internal Financial Controls with reference to financial statements to future periods are subject to the risk that the Internal Financial Controls with reference to financial statements may become inadequate because of changes in conditions, or that the degree of compliance with the policies or procedures may deteriorate.

## **Opinion**

In our opinion, the Company, have in all material respects, an adequate Internal Financial Controls with reference to financial statements and such Internal Financial Controls with reference to financial statements were operating effectively as at 31 March 2021, based on the internal control over financial reporting criteria established by the Company considering the essential components of internal control

stated in the Guidance Note on Audit of Internal Financial Controls with reference to financial statements issued by the Institute of Chartered Accountants of India.

**For LOYA AND MUNDADA**  
**Chartered Accountants**  
Firm Registration Number. 132811W

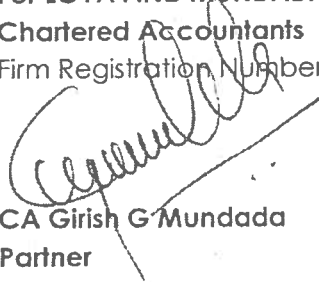
  
**CA Girish G Mundada**  
**Partner**  
Membership Number. 141172



Mumbai  
30/11/2021

## ANNEXURE "B" TO THE INDEPENDENT AUDITOR'S REPORT

(Referred to in paragraph 2 under 'Report on Other Legal and Regulatory Requirements' section of our report to the Members of Supreme Transport Organisation Private Limited of even date)

- I. In respect of the Company's fixed assets:
  - (a) The company has maintained proper records showing full particulars including quantitative details and situation of fixed assets.
  - (b) A substantial portion of fixed assets has been physically verified by the management during the year and in our opinion the frequency of verification is reasonable having regard to the size of the company, the nature of its assets.  
According to the information given to us and to the best of our knowledge, no material discrepancies were noticed on such physical verification.
  - (c) According to the information and explanations given to us and the records examined by us, we report that, the title deeds, comprising the immovable property of Land, are held in the name of company as at the balance sheet date.
- ii.
  - (a) As explained to us, the Inventory has been physically verified by the management at reasonable intervals during the year.
  - (b) In our opinion and according to the information and explanations given to us, no material discrepancies were noticed on physical verification.
- iii. According to the information and explanations given to us and the records examined by us, the Company has complied with section 189 of the Companies Act, 2013 wherever applicable.
- iv. In our opinion and according to the information and explanations given to us, the Company has complied with section 185 and 186 of the Companies Act, 2013 wherever applicable. Except to the extent of temporary loans given to director for business exigency purpose.
- v. According to the information and explanations given to us, the company has not accepted deposits during the year. The company generally complied with the provisions of Sections 73 to 76 or any other relevant provisions of the Companies Act, 2013.



- vi. According to the information and explanations given to us, cost records as prescribed by the central Government under section 148(1) of the Companies Act, 2013 are not required to be maintained.
- vii. (a) According to the information and explanations given to us and the records examined by us, opinion, the company has generally been regular in depositing with appropriate authorities undisputed statutory dues including Provident Fund, Employees' State Insurance, Income-tax, Service tax, value added tax, except Goods and Service tax which is delayed due to cash flow mismatch, cess and any other material statutory dues applicable to it. There were no arrears of such dues at the yearend which have remain outstanding for a period of more than six months from the date they became payable.
- (b) According to the information and explanations given to us and the records examined by us, company has no dues in respect of Income Tax, Service Tax, GST and value added tax which has not been deposited on account of any dispute except delayed payments of GST due to mismatch of receipt of revenue.
- viii) Based on the audit procedure and according to the information and explanations given to us. we are of the opinion that the company has defaulted in repayment of principal and/or interest to banks, financial institutions wherein the period of delay ranges from to 365 days and in some cases more than 365 days. The exact penal interest rate as well as other charges are not ascertainable as no balance confirmation has been received from the banks and most of the loans are under SARFAESI.
- ix) The company has not raised moneys by way of further public offer. Further, in our opinion and according to the information and explanations given to us, the moneys raised by way of debt instruments and term loans have been applied by the company during the year for the purposes for which they are raised.
- x) To the best of our knowledge and according to the information and explanations given to us, no fraud by the company and no material fraud on the company by its officers or employees, noticed or reported to us by the management during the year Management's Responsibility for the Financial Statements
- xi) Since the company is a Private Limited company, provisions of sections 97 read with schedule V of the Act regarding payment of managerial remunerations is not applicable.



- xii. In our opinion and according to the information and explanations given to us, Company is not a Nidhi Company. Accordingly reporting under paragraph 3(xii) of the Order is not applicable.
- xiii. In our opinion and according to the information and explanations given to us, transactions entered by the Company with related parties are in compliance with section 188 of the Act, to the extent applicable. Being an unlisted Company provisions of section 177 of the Act are not applicable. In our opinion, details of transactions with the related parties have been disclosed in the financial statements as required by the applicable accounting standards.
- xiv. According to the information and explanations give to us and based on our examination of the records of the Company, the Company has not made any preferential allotment or private placement of shares or fully or partly convertible debentures during the year and hence reporting under clause 3(xiv) are not applicable to the company.
- xv. According to the information and explanations given to us and based on our examination of the records of the Company, the Company has not entered into non-cash transactions with directors or persons connected with him. Accordingly, reporting under paragraph 3(xv) of the Order are not applicable.
- xvi. The company is not required to be registered under section 45-IA of the Reserve Bank of India Act, 1934.

**For LOYA AND MUNDADA**  
**Chartered Accountants**  
Firm Registration Number. 132811W

**CA Girish G Mundada**  
**Partner**  
Membership Number. 141172  
Mumbai  
30/11/2021

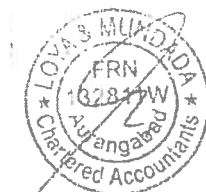

Supreme Transport Organisation Private Limited  
CIN : U60230MH2008PTC216143  
Balance Sheet as at 31st March 2021

Particulars	Note	Amount (Rs.)	
		As at 31st March, 2021	As at 31st March, 2020
<b>A EQUITY &amp; LIABILITIES</b>			
<b>1 Shareholders' Funds</b>			
(a) Share capital	2	7,00,00,000	7,00,00,000
(b) Reserves & surplus	3	(4,94,59,872)	(1,69,56,353)
		<u>2,05,40,128</u>	<u>5,30,43,647</u>
<b>2 Non Current Liabilities</b>			
(a) Long-term borrowings	4	16,68,78,388	17,02,46,059
(b) Long term Provisions		-	-
(b) Deferred Tax Liabilities		6,46,68,340	6,27,38,155
		<u>23,15,46,728</u>	<u>23,29,84,213</u>
<b>3 Current Liabilities</b>			
(a) Short-term borrowings	5	(1,77,73,503)	(1,77,73,503)
(b) Trade payables	6	23,72,63,399	5,18,74,067
(c) Other current liabilities	7	6,11,19,955	26,29,62,133
(d) Short-term provisions	8	-	2,18,70,804
		<u>28,06,09,851</u>	<u>31,89,33,501</u>
		<u>53,26,96,707</u>	<u>60,49,61,362</u>
<b>B ASSETS</b>			
<b>1 Non-current assets</b>			
<b>(a) Fixed assets</b>			
(i) Tangible Assets	9	24,90,15,882	28,40,49,566
(ii) Capital Work in Progress		-	-
(b) Non-current investments	10	11,54,87,330	11,54,87,330
(c) Long Term loans and advances	11	1,78,95,633	2,76,69,041
(d) Deferred Tax Assets		-	-
		<u>38,23,98,845</u>	<u>42,72,05,937</u>
<b>2 Current Assets</b>			
(a) Trade Receivables	12	6,21,69,824	6,38,28,999
(b) Cash & cash equivalents	13	46,93,134	47,25,883
(c) Short term loan and advances	14	8,34,34,905	10,92,00,543
(d) Other Current Assets	15	-	-
		<u>15,02,97,862</u>	<u>17,77,55,425</u>
		<u>53,26,96,707</u>	<u>60,49,61,362</u>

Significant Accounting Policies 1  
Notes on Financial Statements 2 to 28

As per our separate report of even date

For, LOYA & MUNDADA  
Chartered Accountants  
Firm Registration Number, 132811W

CA Girish G Mundada  
Partner  
Membership Number. 141172

Date : 30-11-2021  
Place: Mumbai

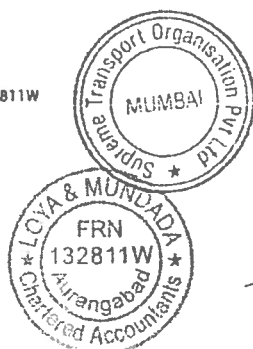

For and on behalf of the Board

Shri Kamal Agarwal  
Chairman & MG Director  
DIN No. 1252090

Captain Ammeel K Agarwal  
Director  
DIN : 05293676

Date : 30-11-2021  
Place: Mumbai

Supreme Transport Organisation Private Limited  
 CIN : U60230MH2008PTC216143  
 Statement of Profit & Loss for the year ended on March 2021

Particulars	Note	Amount (Rs.)	
		For the Period Ended 31st March 2021	For the Period Ended 31st March 2020
1 Revenue from Operations	16	23,51,58,386	20,07,41,360
		23,51,58,386	20,07,41,360
2 Other Income	17	1,72,07,822	1,63,46,589
<b>3 Total Revenue</b>		<b>25,23,66,208</b>	<b>21,70,87,949</b>
<b>Expenses</b>			
Purchase of Stock in Trade	18	21,76,32,360	10,14,61,353
Purchases of Shares			
Employee Benefits expense	19	1,23,83,750	2,87,12,604
Finance Costs(Net)	20	12,95,440	35,32,697
Depreciation		3,39,71,562	4,18,98,515
Other Expenses	21	1,78,71,660	8,75,88,989
<b>4 Total Expenses</b>		<b>28,31,54,771</b>	<b>26,31,94,157</b>
<b>5 Profit before tax</b>		<b>(3,07,88,564)</b>	<b>(4,61,06,208)</b>
<b>6 Provision for Tax</b>			
Current			
Short/Excess Provision		2,15,230	(1,72,749)
Deferred		(19,30,185)	(22,97,928)
		(17,14,955)	(24,70,677)
<b>7 Profit for the period</b>		<b>(3,25,03,519)</b>	<b>(4,85,76,885)</b>
<b>8 Earnings Per Share</b>			
Basic & Diluted	22	-4.64	-6.94
Significant Accounting Policies	1		
Notes on Financial Statements	2 to 28		

As per our separate report of even date

For. LOYA & MUNDADA  
 Chartered Accountants  
 Firm Registration Number. 132811W

CA Girish Mundada  
 Partner  
 Membership Number. 141172

Place: Mumbai  
 Date : 30-11-2021

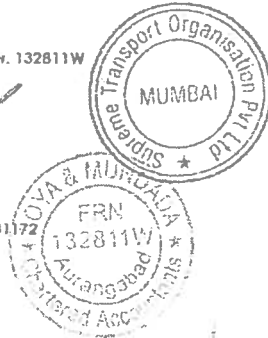

For and on behalf of the Board

Shri Kamal Agarwal  
 Chairman & MG Director  
 DIN No. 1252090

Captain Ammeet K. Agarwal  
 Director  
 DIN : 05293676

Place: Mumbai  
 Date : 30-11-2021

Supreme Transport Organisation Private Limited  
 CIN : U60230MH2008PTC216143  
 Cash Flow Statement for the year ended on 31st March, 2021

Particulars	For the Year Ended 31st March, 2021	For the Year Ended 31st March, 2020
<b>A. Cash Flow from Operating Activities</b>		
Net Profit Before Taxation and extra ordinary items	(3,07,88,564)	(4,61,06,208)
<b>Adjustment for Non Operating &amp; Non Cash Items:</b>		
- Depreciation & Amortisation	3,39,71,562	4,16,98,514.65
- Amount Written Off	-	-
- Profit on Sale of Assets	(35,99,387)	(1,26,55,583)
- Dividend Income	-	-
- Profit on Sale of Mutual Funds	-	-
- Bad Debt Written Off	-	-
- Long Term Provision	-	-
- Short/Excess Provision	-	-
- Finance Cost	12,95,440	35,32,697
	3,13,67,615	32,75,629
Operating Profit before working capital changes	5,79,051	(1,33,30,579)
<b>Changes in working capital</b>		
<b>Adjustment for Increase / Decrease in Operating Assets</b>		
- inventories	0	-
- Trade Receivable	16,59,175	5,72,19,990
- Long Term Loans & Advances	-	-
- Short Term Loans & Advances	2,57,65,638	4,14,53,671
- Other Current Assets	-	-
	2,74,24,813	9,86,73,661
<b>Adjustment for Increase / Decrease in Operating Liabilities</b>		
- Trade Payable	18,53,89,332	(4,98,40,411)
- Other Current Liabilities	(20,18,42,178)	1,23,18,788
- Other Short Term Provisions	(2,18,70,804)	-
- Short Term Borrowings	-	(3,23,24,353)
	(3,83,23,650)	(6,98,45,976)
Cash Flow from Extra Ordinary Items		
Cash Generated from Operations	(1,03,19,786)	1,54,97,106
Net Taxes Paid	(17,14,955)	(24,70,677)
<b>Net Cash Flow from / (used in) Operating Activities (A)</b>	<b>(1,20,34,741)</b>	<b>1,30,26,429</b>
<b>B. Cash Flow from Investing Activities</b>		
- Expenditure of Fixed Assets(Net) & Capital WIP	-	(80,372)
- Capital Work In Progress	-	-
- Dividend Income	-	-
- Proceeds on sale of investments	-	-
- Long Term loans & advances	97,73,408	(28,33,187)
- Current Investments	-	-
- Cashflow from Disposal of asset	49,61,509	1,47,74,985
- Non Current Investment	-	-
<b>Net Cash Flow from / (used in) Investing Activities (B)</b>	<b>1,47,34,917</b>	<b>1,18,61,426</b>



Supreme Transport Organisation Private Limited  
 CIN : U60230MH2008PTC216143  
 Cash Flow Statement for the year ended on 31st March, 2021

Particulars	For the Year Ended 31st March, 2021	For the Year Ended 31st March, 2020
<b>C. Cash Flow from Financing Activities</b>		
- Amount Paid on Buy-back of Shares (Incl. Taxes thereon)		
- Proceeds of Long Term Borrowings	(33,67,670)	(2,06,85,749)
- Proceeds of Short Term Borrowings		
- Proceeds of Short Term Borrowings		
- Proceeds of Long Term Provisions	19,30,185	22,97,928
- Tax on Dividend		
- Finance Cost	(12,95,440)	(35,32,697)
- Dividend Paid		
<b>Net Cash flow from / (used in) Financing Activities (C)</b>	<b>(27,32,925)</b>	<b>(2,19,20,518)</b>
<b>Net Increase / (Decrease) in Cash &amp; Cash Equivalents (A+B+C)</b>	<b>(32,749)</b>	<b>29,67,336</b>
Cash & Cash Equivalent at the beginning of the Year	47,25,883	17,58,545
<b>Cash &amp; Cash Equivalent at the end of the Year</b>	<b>46,93,134</b>	<b>47,25,883</b>
<b>Components of Cash &amp; Cash Equivalents:</b>		
Cash on Hand	22,03,625	18,43,360
With Bank	24,89,509	28,82,523
<b>Total Cash &amp; Bank Balances</b>	<b>46,93,134</b>	<b>47,25,883</b>

**Notes:**

- (i) The Cash Flow Statement reflects the combined cash flows pertaining to continuing and discounting operations.  
 (ii) These earmarked account balances with banks can be utilised only for the specific identified purposes.

As per our separate report of even date

For, LOYA & MUNDADA  
 Chartered Accountants  
 Firm Registration Number, 132811W

CA Gijsh G Mundada  
 Partner  
 Membership Number, 141172  
 UDIN: 2214172AETVAG4157



For and on behalf of the Board

Shri Kamal Agarwal  
 Chairman & MG Director  
 DIN No. 1252090

Captain Ammeet K. Agarwal  
 Director  
 DIN : 05293676

Date : 15-11-2021  
 Place: Mumbai

Supreme Transport Organisation Private Limited  
 CIN: U60230MH2008PTC216143  
 Provisional Notes forming part of Accounts for the year ended on 31st March 2020

Particulars	As at 31st March 2021		As at 31st March 2020	
	Number of Shares (C.Y.)	Number of Shares (P.Y.)		
<b>Note 2: Share capital</b>				
(a) Authorised share capital Equity shares of ₹ 10/- each	7,00,00,000	7,00,00,000	70,00,00,000	70,00,00,000
(b) Issued Equity shares of ₹ 10/- each	70,00,000	70,00,000	70,00,000	7,00,00,000
			<b>70,00,000</b>	<b>7,00,00,000</b>
(c) Subscribed & fully paid up Equity shares of ₹ 10/- each	70,00,000	70,00,000	70,00,000	7,00,00,000
			<b>70,00,000</b>	<b>7,00,00,000</b>

Notes

(i) Details of shares held by each shareholder holding more than 5% shares

Name of Shareholders	No. of Shares (C.Y.)	% holding in that class of shares	No. of Shares (P.Y.)	% holding in that class of shares
Komal Agarwal	16,40,000	52%	16,40,000	52%
Vinod Agarwal	8,40,000	12%	8,40,000	12%
Ganesh Agarwal	8,40,000	12%	8,40,000	12%
Holding under Prepaid	8,40,000	12%	8,40,000	12%
Holding under Prepaid	8,40,000	12%	8,40,000	12%

(ii) The Reconciliation of the number of shares outstanding at the beginning and at the end of the reporting period

Particulars	As at 31st March 2021		As at 31st March 2020	
	No. of Shares (C.Y.)	Amount (₹)	No. of Shares (P.Y.)	Amount (₹)
Equity Shares at the beginning of the year	70,00,000	7,00,00,000	70,00,000	7,00,00,000
Shares Eschiquished over Joint Buy Back (Refer Note-3)				
Shares Issued pursuant to Bonus Issue				
Equity Shares at the end of the year	<b>70,00,000</b>	<b>7,00,00,000</b>	<b>70,00,000</b>	<b>7,00,00,000</b>

Particulars	As at 31st March 2021		As at 31st March 2020	
<b>Note 3: Reserves &amp; Surplus</b>				
<b>Surplus</b>				
Balance in Profit & Loss Account		(1,69,56,353)		3,16,20,537
Add: Net Profit for the year		(3,25,03,519)		(4,85,76,581)
		<b>(4,94,59,872)</b>		<b>(1,69,56,353)</b>
<b>Total</b>		<b>(4,94,59,872)</b>		<b>(1,69,56,353)</b>

**Note 4: Long-term borrowings**

**A- Secured**

From Banks		
Kotak Mahindra Bank - 0651DL0100000023	42,13,288	42,13,288
Kotak Mahindra Bank - 0651DL0100000024	79,22,030	79,22,030
Kotak Mahindra Bank - 0651DL0100000017	3,40,45,099	3,40,45,099
Axis Bank Term Loan - 917060029132434	10,50,50,000	10,50,50,000
<b>Total</b>	<b>15,12,30,417</b>	<b>15,12,30,417</b>

(Note 1 - All above mentioned Commercial loans are secured by mortgage of movable & immovable properties registered in the name of company)

**From Other than Bank**

Secured Loans	1,04,93,474	1,27,05,211
	<b>1,04,93,474</b>	<b>1,27,05,211</b>

(Note 2 - These loans are secured by mortgage of commercial vehicles registered in the name of company)

**A- Unsecured**

From Directors		4,49,272
From Companies	51,54,497	58,61,159
	<b>51,54,497</b>	<b>63,10,431</b>
<b>Total</b>	<b>16,68,78,388</b>	<b>17,02,46,059</b>



Supreme Transport Organisation Private Limited  
 CIN U60230MH2008PTC216143  
 Provisional Notes forming part of Accounts for the year ended on 31st March 2020

Particulars	As at 31st March 2021	As at 31st March 2020
<b>Note 5: Short-term borrowings</b>		
<b>Secured</b>		
Cash Credit		
from Banks	(1,77,73,503)	(1,77,73,503)
From Others		
<b>Total</b>	<b>(1,77,73,503)</b>	<b>(1,77,73,503)</b>
<b>Note 6: Trade payables</b>		
Trade payables - for goods	23,72,63,399	5,18,74,067
<b>Total</b>	<b>23,72,63,399</b>	<b>5,18,74,067</b>
<b>Note 7: Other current liabilities</b>		
<b>Other Payable</b>		
(i) Advance from Customers	4,44,67,415	16,45,79,339
(ii) Other liabilities	1,66,52,540	9,83,22,794
<b>Total</b>	<b>6,11,19,955</b>	<b>26,29,02,133</b>
<b>Note 8: Short-term provisions</b>		
Provision for Taxation		2,18,70,804
<b>Total</b>	<b>-</b>	<b>2,18,70,804</b>
<b>Note 10: Non-current investments</b>		
<b>(a) Quoted Investments</b>		
<b>(b) Unquoted Investments</b>		
1) Equity Instruments	2,830	12,830
2) Property	11,54,74,500	11,54,74,500
<b>Total</b>	<b>11,54,87,330</b>	<b>11,54,87,330</b>
<b>Note 11: Long-term loans &amp; advances</b>		
(a) Security Deposit		
(b) Loans and Advances	1,78,95,633	2,76,69,041
Advances receivable in cash or in kind for the value to be received. Considered Current		
(c) Advance against agreement to Sale (Sankshat)		
(d) Provision of Tax & Net of the Payment		
	1,78,95,633	2,76,69,041
<b>Note 11: Current investments</b>		
<b>Total</b>		
<b>Note 12: Trade receivables</b>		
(Unsecured Considered Good)		
Outstanding over six months	6,21,69,824	6,38,28,999
Others		
<b>Total</b>	<b>6,21,69,824</b>	<b>6,38,28,999</b>



Supreme Transport Organisation Private Limited  
 CIN : U60230MH2008PTC216143  
 Provisional Notes forming part of Accounts for the year ended on 31st March 2020

Particulars	As of 31st March 2021	As of 31st March 2020
<b>Note 13. Cash and cash equivalents</b>		
(a) Cash On Hand	22,03,625	18,43,360
(b) Balances With Schedule Banks		
(i) In Current A/c	15,70,367	19,63,381
(ii) In Fixed Deposit A/c	9,19,142	9,19,142
<b>Total</b>	<b>46,93,134</b>	<b>47,25,883</b>
<b>Note 14. Short term loans &amp; advances</b>		
(a) Loans and Advances		
Advances receivable in cash or in kind for the value to be received (Unsecured Grant)	4,81,54,474	4,26,74,374
(b) Prepaid Expenses	3,52,89,430	6,63,26,159
(c) Balance with Government Authorities	8,34,34,905	10,92,00,543
<b>Total</b>	<b>16,68,78,809</b>	<b>21,82,01,076</b>
<b>Note 15. Other current assets</b>		
(a) Accruals		
(b) Interest receivable		
<b>Total</b>	<b>-</b>	<b>-</b>
<b>Note 16. Revenue from Operations</b>		
<b>Sale of Services - Aviation Division</b>		
Aviation Passenger Services		6,63,89,327
Airport Development & Consultancy	15,26,56,245	
Other Operating Subsidy	15,26,56,245	6,63,89,327
<b>Total</b>	<b>30,53,12,490</b>	<b>13,27,78,654</b>
<b>Sale of Services - Transport Division</b>		
Goods Transport Services	8,25,02,141	13,43,54,033
	8,25,02,141	13,43,54,033
<b>Total</b>	<b>16,50,04,282</b>	<b>26,87,08,066</b>
<b>Note 17. Other income</b>		
FDR Interest		1,31,374
Godown Penl	3,19,000	1,27,607
Interest others	57,61,875	1,17,993
Reimbursement of Expenses (Supreme Airbus)		21,00,000
Insurance Refund	1,32,416	1,56,724
Other Income	60,01,900	10,17,049
Profit on sale of vehicle (Net)	38,99,367	1,26,55,553
Profit on sale of Property		
Interest on Income tax refund	10,93,304	
<b>Total</b>	<b>1,72,07,822</b>	<b>1,63,44,589</b>
<b>Note 18. Purchase of Stock in Trade</b>		
<b>Transport Division</b>		
Lorry Hire & Labour Charges	6,52,14,709	9,15,25,225
Petrol & Diesel Expense	24,02,379	26,24,109
Loading & Unloading Charges	14,73,405	21,450
Door Delivery Charges		6,800
Detention Charges	15,000	2,71,609
	6,91,05,493	7,44,48,196
<b>Aviation Division</b>		
Custom Duty		2,85,505
Freight, Customs, Clearing & Forwarding	8,59,118	1,24,768
Container & Vehicle Rent	27,510	3,45,933
Equipment & Spare parts	14,22,67,591	27,67,559
DGCA & AAI Expenses		1,64,800
Airport Consistency & Development		35,01,103
Aircraft Insurance		24,000
Pilot & Crew Training Expense	33,72,648	
Airport Development Labour Charges	14,85,26,967	70,13,156
<b>Total</b>	<b>21,74,32,340</b>	<b>10,14,61,353</b>
<b>Note 19. Employee benefits expenses</b>		
Salaries, wages and bonus	1,18,11,917	1,77,30,242
Contribution to P.F.	91,833	1,68,087
ESIC Expenses		28,193
Service & Retainer ship	4,80,000	1,05,66,087
Director Remuneration, Bonus, rent & Commission		7,20,000
<b>Total</b>	<b>1,23,83,750</b>	<b>2,97,12,609</b>

Balance Sheet 20-21

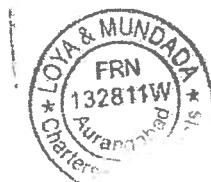

Supreme Transport Organisation Private Limited  
 CIN: U80230MH2008PTC2716143  
 Provisional Notes forming part of Accounts for the year ended on 31st March 2020

Particulars	As at	
	31st March 2021	31st March 2020
<b>Note 20: Finance costs</b>		
Bank Charges	67,456	2,11,458
Period Interest & Charges		15,75,806
Interest On TDS Deductions	7,065	1,198
Interest on Trade Loans	1,20,912	19,44,241
<b>Total</b>	<b>12,95,440</b>	<b>25,32,697</b>

<b>Note 21: Other expenses</b>		
Accident Expense	1,69,576	900
Agent Fees	2,25,000	2,70,000
Brokerage & Commission Expenses	20,555	1,01,794
Business Promotion	2,72,161	4,12,050
Bus/Gets		4,97,01,092
Claim Expenses		3,621
Conveyance & Motor Car Expenses	5,26,059	6,37,814
Drawing Expense		42,180
Party Entertainment Expenses		45,700
Remounter Expense		47,192
Donation Expenses		2,03,526
Electricity Expenses	1,35,798	12,25,457
Financial Expenses	10,86,016	9,27,192
Prior Period Expenses		1,36,503
Insurance Expenses	12,40,704	40,74,242
GST on Motor Cars		1,10,073
Service Tax		1,39,864
Legal & Professional Fees	6,22,166	12,44,791
Lodging & Boarding		8,73,073
Membership & Subscription		2,575
Medical Expense		35,147
Motor Car Expense		2,15,457
Office & Godown Rent	76,43,777	28,61,744
Office Expenses	1,24,607	30,71,161
Parking Charges	4,00,678	7,56,426
Postage & Courier Expenses	58,616	71,869
Printing & Stationery Expenses	2,12,614	1,99,454
Other Taxes	13,08,099	36,72,190
Repairs & Maintenance Expenses	67,74,566	69,70,808
Staff Welfare Expenses	12,28,006	14,06,852
Security Charges	7,01,491	3,44,725
Society Charges		24,762
Telephone, Internet & Mobile Expenses	4,29,325	12,71,562
Prior Period Expenses	77,600	
Tender Fees		85,710
Way Expense		16,834
Traveling Expenses	4,21,644	5,12,621
<b>Total</b>	<b>1,78,71,660</b>	<b>8,75,88,989</b>

Payment to Auditor		
Audit Fee	3,25,000	2,70,000
Professional Fee	1,45,000	1,05,000

**Note 22: Earnings Per Share (EPS)**

<b>Basic &amp; Diluted EPS</b>		
Net Profit after tax as per statement of Profit and Loss attributable to Equity Shareholders	(3,25,03,519)	(4,85,74,885)
Weighted Average number of equity shares used as denominator for calculating EPS	70,00,000	70,00,000
	(5)	(6.74)

**Adjusted EPS**

Net Profit after tax as per statement of Profit and Loss attributable to Equity Shareholders	(3,25,03,519)	(4,85,74,885)
Weighted Average number of equity shares used as denominator for calculating EPS	70,00,000	70,00,000
	(5)	(6.74)

Face value per equity share:

10 10



Supreme Temporal Corporation Private Limited  
 C/o Institutional Investor Cell  
 New Jersey part of accounts for the year ended on 31st March 2021

Rate % of Assets  
 Transferable shares

Particulars	Rate	Gross Total			Depreciation			Amount (Rs.)	
		Opening Balance As on 01/07/2020	Additions	Withdrawal	Closing Balance as on 31/03/2021	For the period	Debit out	Closing Balance as on 31/03/2021	Closing Balance as on 01/07/2020
GRN	31.73%	5,82,29,151	-	17,71,009	10,79,49,029	19,54,891	1,18,99,441	14,35,891	5,13,74,138
Yantras	43.14%	17,46,884	-	-	1,41,47,344	3,64,041	-	3,64,041	2,24,106
Office Buildings	25.80%	1,33,88,829	-	-	1,13,88,829	1,10,652	-	1,10,652	1,82,947
Caravan	25.80%	9,49,735	-	-	8,49,735	27,710	-	27,710	77,867
Transportation	45.07%	17,73,634	-	-	7,20,035	41,746	-	41,746	3,08,177
Business equipment	13.91%	6,51,652	-	-	5,52,451	3,03,26,608	-	3,03,26,608	55,978
IT Equipments	31.23%	1,20,96,355	-	-	34,20,98,356	7,47,265	-	7,47,265	8,77,30,772
Motor Vehicles	63.16%	25,29,843	-	-	12,37,840	13,230	-	13,230	1,07,82,448
Summands				1,27,12,601	55,81,82,328	1,10,71,842	1,18,99,441	30,94,73,467	31,80,14,802
Total		56,35,43,317		1,27,12,601	55,81,82,328	1,10,71,842	1,18,99,441	30,94,73,467	31,80,14,802
Pre-2021 Year		1,02,27,337			56,12,42,12	23,81,92,47	1,43,09,243	31,28,15,131	31,40,07,111



**SUPREME TRANSPORT ORGANISATION PRIVATE LIMITED  
SCHEDULES FORMING PART OF ACCOUNTS  
FOR THE PERIOD ENDED MARCH 31, 2021**

**Schedule 22 : Notes to Accounts**

**1. Nature of Operations**

Supreme Transport Organisation Private Limited ("the Company") was incorporated on May 29, 2008. The Company is engaged in the business of Transport of Goods by road & developing airports in & all over India and also providing consultancy services in the developments of airports.

**2. Statement of Significant Accounting Policies**

**(a) Basis of preparation**

The financial statements have been prepared to comply in all material respects with the Accounting Standards notified by Companies (Accounting Standards) Rules, 2006, (as amended) and the relevant provisions of the Companies Act, 2013 ("the Act"). The financial statements have been prepared under the historical cost convention on an accrual basis. The accounting policies have been consistently applied by the Company and are consistent with those used in the previous period.

**(b) Use of estimates**

The preparation of financial statements in conformity with generally accepted accounting principles requires management to make estimates and assumptions that affect the reported amounts of assets and liabilities and disclosure of contingent liabilities at the date of the financial statements and the results of operations during the reporting period. Although these estimates are based upon management's best knowledge of current events and actions, actual results could differ from these estimates.

**(c) Fixed Assets**

Fixed assets are stated at cost less accumulated depreciation. Cost comprises of the purchase price and any attribute able cost of bringing the asset to its working condition for its intended use. Borrowing costs relating to acquisition of fixed assets which takes substantial period of time to get ready for its intended use are also included to the extent they relate to the period till such assets are ready to be put to intended use.

**(d) Depreciation**

Depreciation is provided using the Written down Value Method as per rates prescribed under schedule II of the Companies Act, 2013 except for leasehold land and software.

Asset Description	Schedule II Useful Life (WDV)
Buildings (other than factory Building)	60 Years
Factory Building	30 Years
Plant and Machineries	15 Years
Furniture and Fittings	10 Years
Office Equipments	10 Years
Computers	6 Years
Vehicles	10 Years



**SUPREME TRANSPORT ORGANISATION PRIVATE LIMITED  
SCHEDULES FORMING PART OF ACCOUNTS  
FOR THE PERIOD ENDED MARCH 31, 2021**

---

**(e) Impairment**

The carrying amounts of assets are reviewed at each Balance Sheet date if there is any indication of impairment based on internal/external factors. An impairment loss is recognized wherever the carrying amount of an asset exceeds its recoverable amount. The recoverable amount is the greater of the asset's net selling price and value in use. In assessing value in use, the Company makes a reasonable estimate of the value in use.

**(f) Revenue Recognition**

Revenue is recognized to the extent that it is probable that the economic benefits will flow to the Company and the revenue can be reliably measured. Interest income is recognized on time proportion basis taking into account the principal amounts outstanding and the rate of interest. Revenue from dividend is recognized when the Company's right to receive payment is established by the Balance Sheet date.

**(g) Foreign currency transactions**

*Foreign currency transactions*

**(i) Initial recognition**

Foreign currency transactions are recorded in the reporting currency, by applying to the foreign currency amount the exchange rate between the reporting currency and the foreign currency at the date of the transaction.

**(ii) Conversion**

Foreign currency monetary items are reported using the closing rate. Non-monetary items which are carried in terms of historical cost denominated in a foreign currency are reported using the exchange rate at the date of the transaction; and non-monetary items which are carried at fair value or other similar valuation denominated in a foreign currency are reported using the exchange rates that existed when the values were determined.

**(iii) Exchange Difference**

Exchange differences arising on the settlement of monetary items or on reporting monetary items of company at rates different from those at which they were initially recorded during the year / period, or reported in previous financial statements, are recognized as income or as expenses in the year / period in which they arise.

**(h) Income taxes**

Tax expense comprises of current and deferred tax.

a) *Current income tax* is measured at the amount expected to be paid to the tax authorities in accordance with the Indian Income Tax Act.

b) *Deferred income taxes* reflects the impact of current year/ period timing differences between taxable income and accounting income for the year and reversal of timing differences of earlier years.

Deferred tax is measured based on the tax rates and the tax laws enacted or substantively enacted at the Balance Sheet date. Deferred tax assets are recognized only to the extent that there is reasonable certainty that sufficient future taxable income will be available against which such deferred tax assets

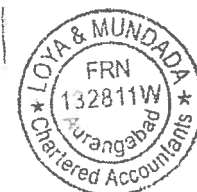

**SUPREME TRANSPORT ORGANISATION PRIVATE LIMITED**  
**SCHEDULES FORMING PART OF ACCOUNTS**  
**FOR THE PERIOD ENDED MARCH 31, 2021**

can be realized. In situations where the Company has unabsorbed depreciation or carry forward tax losses, all deferred tax assets are recognized only if there is virtual certainty supported by convincing evidence that they can be realized against future taxable profits.

At each Balance Sheet date the Company re-assesses unrecognized deferred tax assets. It recognizes unrecognized deferred tax assets to the extent that it has become reasonably certain or virtually certain, as the case may be that sufficient future taxable income will be available against which such deferred tax assets can be realized.

The carrying amount of deferred tax assets are reviewed at each Balance Sheet date. The Company writes-down the carrying amount of a deferred tax asset to the extent that it is no longer reasonably certain or virtually certain, as the case may be, that sufficient future taxable income will be available against which deferred tax asset can be realized. Any such write-down is reversed to the extent that it becomes reasonably certain or virtually certain, as the case may be, that sufficient future taxable income will be available.

**(i) Retirement and other employee benefits**

The company has not provided or form any provision in the form of retirement benefit during the year. Retirement Benefits are provided to employee at the time of retirement. Short term employee benefits are recognized as an expense in the profit and loss account for the year in which the related service is rendered. Payment of Gratuity is made at the time of retirement of employee.

**(j) Prior Period and Extra Ordinary Items**

Items of Income and Expenditure pertaining to Prior Period as well as Extra Ordinary Items, where material, are disclosed separately.

**(k) Investments**

Investments that are readily realizable and intended to be held for not more than a year are classified as current investments. All other investments are classified as long-term investments. Current investments are carried at lower of cost and fair value determined on an individual investment basis. Long-term investments are carried at cost. However, provision for diminution in value is made to recognize a decline other than temporary in the value of the investments.

**(l) Inventories**

The company is in the business of GTA & Airport development services so the inventories of raw material were not required to maintained as this is the service industry.

**(m) Earnings Per Share**

Basic earnings per share are calculated by dividing the net profit or loss for the period attributable to equity shareholders by the weighted average number of equity shares outstanding during the period. For the purpose of calculating diluted earnings per share, the net profit or loss for the period attributable to equity shareholders and the weighted average number of shares outstanding during the period are adjusted for the effects of all dilutive potential equity shares, except where the shares are anti-dilutive.



**SUPREME TRANSPORT ORGANISATION PRIVATE LIMITED  
SCHEDULES FORMING PART OF ACCOUNTS  
FOR THE PERIOD ENDED MARCH 31, 2021**

**(n) Provisions**

A provision is recognized when an enterprise has a present obligation as a result of past event; it is probable that an outflow of resources will be required to settle the obligation, in respect of which a reliable estimate can be made. Provisions are not discounted to its present value and are determined based on best estimate required to settle the obligation at the Balance Sheet date. These are reviewed at each Balance Sheet date and adjusted to reflect the current best estimates.

**(o) Cash and Cash equivalents**

Cash and cash equivalents for the purposes of cash flow statement comprise cash at bank and in hand and short-term investments with an original maturity of three months or less.

**3. Additional Disclosure**

1. Freight Income are registered on accrual systems under bulk booking and on cash system under loose booking. All the direct and indirect expenses are accounted on accrual basis except telephone, mobile & electricity expenses which have been accounted on payment basis.
2. In the opinion of the management the current assets loans & advances and sundry debtors are approximately of the value stated if realized in the ordinary course of business. However, in respect of sundry debtors; dues to the tune of Rs 1,27,22,621/- are subject to litigation and cases are pending at NCLT.
3. Closing balance of sundry debtors, sundry creditors and deposit accounts are subject to confirmation and are taken as per books of accounts.
4. All the expenditure covered under section 40A (3) and section 40A(3A) read with rule 6DD which have not been verified due to non-availability /possession of necessary evidence by the company.
5. The secured loan balances from IIFL, Shriram Transport Finance Company Limited, HDFC Bank and Indusind Bank are subject to balance confirmation from banks and are taken as per books of accounts. Kotak Mahindra Bank had initiated auction of 3 flats against which it had disbursed loan. As per RT order dated. 15-02-2019 the claim settlement amount is Rs. 20 crores. The Company has partly paid the outstanding amount of the loan and still Rs. 4.80 cores are pending to be paid. However, Kotak Mahindra bank in its Cash Credit Account continues to charge interest which has not been considered in books as the settlement order has come from DRT.  
However, the bank has sold off 2 of the properties (Property No. 143 and Property No. 223) recover the loans and company has not accepted the same and filed a suit against the bank for unauthorized sale. Hence the said properties are still appearing in the books.
6. An amount to the tune of Rs 54738644 consisting of following
  - a. Rent & Maintenance receivable from the following for unauthorized usage of Company properties by them (+ Interest@24%)

Name	Amount of Rent (01.02.2015-06.02.2019)	Amount of Maintenance (01.02.2015-06.02.2019)
Ravindra Agarwal	Rs. 1,92,00,000/-	Rs. 20,02,638/-
Anand Agarwal	Rs. 96,00,000/-	Rs. 10,01,319/-



**SUPREME TRANSPORT ORGANISATION PRIVATE LIMITED  
SCHEDULES FORMING PART OF ACCOUNTS  
FOR THE PERIOD ENDED MARCH 31, 2021**

- b. Unauthorized transfer from company's account directly to their personal account by following (+ Interest@24%).

Name	Amount Rs
Satish Agrawal	51,22,535.00
Arun Agrawal	25,57,791.00
Anand Agrawal	15,66,240.00

- c. Unauthorized withdrawal from company's account (+ Interest@24%)

Name	Amount Rs
Ravindra Agrawal	56,32,842.75
Anand Agrawal	56,32,842.75
Satish Agrawal	56,32,842.75
Arun Agrawal	56,32,842.75

7. The company has granted and taken unsecured loans to and from companies covered in the register maintained under section 189 of the Companies Act, 2013 in compliance with the provisions of section 188 of the companies act, 2013. However, the company has given temporary advance to director to the tune of Rs 1,20,09,910/- in contravention to section 185 for business exigency purpose.

**4. Related Party Disclosures**

**a) Key Management Personnel**

Name of the person	Relationship
Kamal Agarwal	Director
Ammeet Agarwal	Director
Akkash Agarwal	Director
Vimal Agarwal	Director
Girish Agarwal	Director

**b) Relatives Key Management Personnel**

Name of the person	Relationship
Sangeeta Agarwal	Wife of Director
Samiksha Agarwal	Wife of Director
Nupur Agarwal	Wife of Director
Pinky Agarwal	Sister of Director

**5. Deferred taxes**

Deferred income tax reflects the impact of timing difference between taxable income and accounting income originating during current year and reverse in subsequent periods. Deferred tax is measured using the tax rates and the tax laws enacted and substantively enacted at the reporting date.



SUPREME TRANSPORT ORGANISATION PRIVATE LIMITED  
SCHEDULES FORMING PART OF ACCOUNTS  
FOR THE PERIOD ENDED MARCH 31, 2021

6. Auditors Remuneration (excluding GST)

(Amount in Rupees)

	As at March 31, 2021 Rupees	As at March 31, 2020 Rupees
Statutory Audit Fees	2,25,000	2,70,000
Tax Audit Fees	50,000	
GST Audit Fees	50,000	
Professional Fees	1,45,000	1,30,000
<b>Total</b>	<b>4,70,000</b>	<b>4,00,000</b>

7. Dues to the Micro and Small Enterprises as per MSMED Act, 2006  
As at March 31, 2021 no supplier has intimated the Company about its status as micro or small enterprises or its registration with the appropriate authority under 'The Micro, Small and Medium Enterprises Development Act, 2006'.
8. Balances with various parties are subject to confirmation.
9. Previous Year Comparatives  
Previous year's figures have been regrouped where necessary to confirm to this year's classification.

For and on behalf of the Board  
Supreme Transport Organisation Pvt Ltd

  
Shri Kamal Agarwal  
Chairman & MG Director  
DIN : 1252090

  
Captain Ammeet K. Agarwal  
Director  
DIN : 05293676

Date : 30-11-2021  
Place: Mumbai



## आरोपीनिहाय अपहार केलेल्या रकमेचा तक्ता

A) सुप्रिम ट्रान्सपोर्ट कंपनीच्या बँक खात्यातुन आरोपी विमल अगरवाल याच्या बँक खात्यामध्ये ट्रान्सफर झालेल्या रकमेचा तपशील:—

From HDFC Bank A/c No1045284000014 to Vimal Agarwal Account			
Sr. No	Date	Transaction details (Narration)	Amount
01	03/04/2018		60,00,000
02	21/05/2018		5,00,000
03	24/05/2018		5,00,000
04	20/06/2018		10,00,000
05	21/06/2018		5,00,000
06	22/06/2018		2,79,960
07	22/06/2018		45,000/-
		Total	88,24,960/-

From HDFC Bank A/c No 03302840000157 to Vimal Agarwal Account			
Sr. No	Date	Transaction details (Narration)	Amount
01	23/07/2018		1,45,000

From HDFC Bank A/c No 01662840000470 to Vimal Agarwal Account			
Sr. No	Date	Transaction details (Narration)	Amount
01	14/08/2018		1,39,980
02	28/09/2018		50,000
03	26/10/2018		55,000
04	08/07/2019		2,46,519
		Total	4,91,499/-

From HDFC Bank A/c No 03302840000140 to Vimal Agarwal Account			
Sr. No	Date	Transaction details (Narration)	Amount
01	06/11/2018		1,50,000

From HDFC Bank A/c No 04072840000053 to Vimal Agarwal Account			
Sr. No	Date	Transaction details (Narration)	Amount
01	13/11/2018	FT CR	75,000
02	15/12/2018	Two Months Rent	30,000

03	30/01/2019	Rent	15,000
04	28/02/2019	Rent	15,000
05	23/03/2019	Rent	15,000
06	27/03/2018	Rent	15,000
07	30/03/2019		25,000
08	17/04/2019		1,00,000
09	20/04/2019		50,000
10	09/05/2019	Rent	20,000
11	15/06/2019		45,000
12	29/06/2019	Rent	20,000
13	03/07/2019		5,90,000
14	16/07/2019		5,000
15	24/07/2019		20,000
16	24/07/2019		16,000
17	31/07/2019	TPT	20,000
18	31/07/2019	TPT	52,000
19	01/08/2019		3,75,000
20	09/08/2019		4,45,000
21	28/08/2019	Rent	20,000
22	05/09/2019		8,00,000
23	29/09/2019	Rent	20,000
24	15/08/2019	TPT	1,00,000
25	30/08/2018	Rent	20,000
26	15/10/2019		1,00,000
27	16/11/2019	TPT	5,00,000
28	21/11/2019	Rent	20,000
29	16/12/2019		5,00,000
30	20/12/2019	Rent	20,000
31	28/01/2020	Rent	20,000
32	07/02/2020	Rent	20,000
33	02/03/2020	Rent	20,000
34	21/03/2020	TPC	65,000
35	24/03/2020	Rent	20,000
36	01/04/2020		5,00,000
37	06/05/2020		50,000
38	06/05/2020	Rent	20,000
39	11/05/2020		1,50,000
40	02/06/2020	Rent	20,000
41	11/06/2020		76,000
42	06/07/2020	Rent	20,000
43	13/08/2020	Rent	20,000
44	24/09/2020	Rent	20,000
45	07/10/2020	Rent	20,000

46	06/11/2020		52,000
47	11/11/2020	Rent	20,000
48	31/12/2020	Rent	20,000
49	06/01/2021	Rent	20,000
50	15/03/2021	Rent	20,000
51	23/03/2021	Rent	20,000
52	26/03/2021	Rent	20,000
53	01/04/2021		5,25,000
54	04/05/2021		3,69,000
55	27/07/2021		8,000
56	27/07/2021		32,000
57	27/07/2021		25,500
58	27/07/2021		2,00,000
		Total	64,60,500/-

From PNB A/c No 10451131002901 to Vimal Agarwal Account			
Sr. No	Date	Transaction details (Narration)	Amount
01	04/03/2022		49,500
02	21/03/2022		2,94,693
03	01/05/2022		98,000
04	01/06/2022		99,000
05	06/07/2022		99,000
06	09/07/2022		2,69,996
		Total	8,11,189/-

From BOI A/c No 843720110000498 to Vimal Agarwal Account			
Sr. No	Date	Transaction details (Narration)	Amount
01	24/10/2019		7,85,000
02	04/01/2020		8,50,000
03	09/01/2020		11,50,000
04	01/06/2020		2,24,000
05	30/12/2020		2,50,000
		Total	32,59,000/-

B) संगीता एव्हीएशन कंपनीच्या बँक खात्यातून आरोपी विमल अग्रवाल याच्या बँक खात्यामध्ये ट्रान्सफर झालेल्या रकमेचा तपशील:—

From DCB A/c No 00421300002745 to Vimal Agarwal Account			
Sr. No	Date	Transaction details (Narration)	Amount
01	02/04/2021		1,00,000
02	01/05/2021		1,00,000

03	01/06/2021		1,00,000
04	01/07/2021		1,00,000
05	02/08/2021		1,00,000
		Total	5,00,000/-

C) अमीत अगरवाल यांच्या बँक खात्यातून आरोपीं विमल अगरवाल यांच्या बँक खात्यामध्ये ट्रान्सफर झालेल्या रकमेचा तपशील:—

From DCB A/c No 00410200001403 to Vimal Agarwal Account			
Sr. No	Date	Transaction details (Narration)	Amount
01	01/09/2021		1,00,000
02	01/01/2022		1,00,000
03	01/02/2022		1,00,000
04	02/03/2022		1,00,000
		Total	4,00,000/-

A	2,01,42,148
B	5,00,000
C	4,00,000
Total	2,10,42,148

A) सुप्रिम ट्रान्सपोर्ट कंपनीच्या बँक खात्यातुन आरोपीं नुपुर अग्रवाल हिच्या बँक खात्यामध्ये ट्रान्सफर झालेल्या रकमेचा तपशील:—

From HDFC Bank A/c No10452840000014 to Nupur Agarwal Account			
Sr. No	Date	Transaction details (Narration)	Amount
01	22/06/2018	Three months rent	45,000
02	22/06/2018	Two months' Salary	78,456
		Total	1,23,456/-

From HDFC Bank A/c No 01662840000470 to Nupur Agarwal Account			
Sr. No	Date	Transaction details (Narration)	Amount
01	04/08/2018	Two Months Rent	30,000
02	14/08/2018	Salary	39,228
03	29/09/2018	Rent	15,000
		Total	81,228/-

From HDFC Bank A/c No 04072840000053 to Nupur Agarwal Account			
Sr. No	Date	Transaction details (Narration)	Amount
01	15/12/2018	Two Month Rent	30,000
02	30/01/2019	Rent	15,000
03	28/02/2019	Rent	15,000
04	23/03/2019	Rent	15,000
05	27/03/2019	Rent	15,000
06	28/03/2019	Rent	15,000
07	09/05/2019	Rent	20,000
08	29/06/2019	Rent	20,000
09	31/07/2019	Rent	20,000
10	28/08/2019	Rent	20,000
11	26/09/2019	Rent	20,000
12	30/10/2019	Rent	20,000
13	21/11/2019	Rent	20,000
14	20/12/2019	Rent	20,000
15	16/01/2020	Salary	39,228
16	20/01/2020	Salary	39,228
17	28/01/2020	Rent	20,000
18	28/01/2020	Salary	39,228
19	31/01/2020	Salary	39,228
20	07/02/2020	Rent	20,000
21	08/02/2020	Salary	39,228
22	18/02/2020	Salary	39,228
23	29/02/2020	Different of Salary for Six Months	4632

24	02/03/2020	Rent	20,000
25	06/03/2020	Salary	40,000
26	11/03/2020	Salary	40,000
27	15/03/2020	Salary	40,000
28	17/03/2020	Salary	40,000
29	21/03/2020	Salary	40,000
30	24/03/2020	Rent	20,000
31	24/03/2020	Salary	40,000
32	06/05/2020	Rent	20,000
33	02/06/2020	Rent	20,000
34	06/07/2020	Rent	20,000
35	13/08/2020	Rent	20,000
36	24/09/2020	Rent	20,000
37	07/10/2020	Rent	20,000
38	11/11/2020	Rent	20,000
39	31/12/2020	Rent	20,000
40	06/01/2021	Rent	20,000
41	15/03/2021	Rent	20,000
42	23/03/2021	Rent	20,000
43	26/03/2021	Rent	20,000
44	26/03/2021	From STOPL	40,000
		Total	10,70,772/-

From BOI A/c No 843720110000498 to Nupur Agarwal Account			
Sr. No	Date	Transaction details (Narration)	Amount
01	24/06/2020	NEFT	40,000
02	30/06/2020	NEFT	40,000
03	01/07/2020	NEFT	40,000
04	14/08/2020	NEFT	40,000
05	09/12/2020	NEFT	40,000
06	16/12/2020	NEFT	40,000
07	07/01/2021	NEFT	40,000
08	12/01/2021	NEFT	40,000
		Total	3,20,000/-

From PNB A/c No 10451131002901 to Nupur Agarwal Account			
Sr. No	Date	Transaction details (Narration)	Amount
01	01/05/2022	NEFT	98,000
02	01/06/2022	NEFT	99,000
03	06/07/2022	NEFT	99,000
		Total	2,96,000/-

B) संगीता एक्वीएशन कंपनीच्या बँक खात्यातुन आरोपीं नुपुर अगरवाल हिच्या बँक खात्यामध्ये ट्रान्सफर झालेल्या रकमेचा तपशील:—

From PNB (Sangeeta) A/c No 10454015001858 to Nupur Agarwal Account			
Sr. No	Date	Transaction details (Narration)	Amount
01	31/03/2021	RTGS	3,17,600
02	02/04/2021	NEFT	1,00,000
03	01/05/2021	NEFT	1,00,000
		Total	5,17,600-

From DCB A/c No 00421300002745 to Nupur Agarwal Account			
Sr. No	Date	Transaction details (Narration)	Amount
01	01/06/2021	NEFT	1,00,000
02	01/07/2021	NEFT	1,00,000
03	02/08/2021	NEFT	1,00,000
		Total	3,00,000/-

C) अमीत अगरवाल यांच्या बँक खात्यातुन आरोपीं नुपुर अगरवाल हिच्या बँक खात्यामध्ये ट्रान्सफर झालेल्या रकमेचा तपशील:—

From DCB A/c No 00410200001403 to Nupur Agarwal Account			
Sr. No	Date	Transaction details (Narration)	Amount
01	01/09/2021	NEFT	1,00,000
02	01/01/2022	NEFT	1,00,000
03	01/02/2022	NEFT	1,00,000
04	02/03/2022	NEFT	1,00,000
		Total	4,00,000/-

From PNB A/c No 10452191004874 to Nupur Agarwal Account			
Sr. No	Date	Transaction details (Narration)	Amount
01	01/10/2021	NEFT	1,00,000
02	01/11/2021	NEFT	1,00,000
03	01/12/2021	NEFT	1,00,000
04	31/03/2022	NEFT	1,00,000
			4,00,000/-

A	18,91,456
B	8,17,600
C	8,00,000
Total	35,09,056

A) सुप्रिम ट्रान्सपोर्ट कंपनीच्या बँक खात्यातून आरोपीं गिरीष आग्रवाल याच्या बँक खात्यामध्ये ट्रान्सफर झालेल्या रकमेचा तपशील:—

From HDFC Bank A/c No 0330284000014 to Girish Agarwal Account			
Sr. No	Date	Transaction details (Narration)	Amount
01	14/08/2018	Director Rem	1,39,980
02	06/11/2018		1,50,000
03	13/02/2020		10,000
04	20/02/2021		35,000
		Total	3,34,980/-

From HDFC Bank A/c No 00602340000085 to Girish Agarwal Account			
Sr. No	Date	Transaction details (Narration)	Amount
01	03/08/2018		1,85,750.49
02	30/09/2019		301.53
03	18/01/2021		1577.38
04	06/09/2021		3.54
05	21/11/2021		86,979.98
06	10/04/2022		16,835.22
07	20/05/2022		72,608.34
		Total	3,24,056.48/-

From HDFC Bank A/c No 03302840000157 to Girish Agarwal Account			
Sr. No	Date	Transaction details (Narration)	Amount
01	21/07/2018		1,50,000
		Total	1,50,000/-

From HDFC Bank A/c No 04072840000053 to Girish Agarwal Account			
Sr. No	Date	Transaction details (Narration)	Amount
01	03/01/2020	Rent	2,40,000
		Total	2,40,000/-

From PNB A/c No 10451131002901 to Girish Agarwal Account			
Sr. No	Date	Transaction details (Narration)	Amount
01	01/05/2022	NEFT	98,000
02	01/06/2022	NEFT	99,000
03	06/07/2022	NEFT	99,000
04		Total	2,96,000/-

B) संगीता एव्हीएशन कंपनीच्या बँक खात्यातून आरोपीं गिरीष अग्रवाल याच्या बँक खात्यामध्ये ट्रान्सफर झालेल्या रकमेचा तपशील:—

From PNB A/c (Sangeeta) to Girish Agarwal Account			
Sr. No	Date	Transaction details (Narration)	Amount
01	31/03/2021	RTGS	8,93,250
Total			8,93,250/-

From DCB A/c 00421300002745 to Girish Agarwal Account			
Sr. No	Date	Transaction details (Narration)	Amount
01	02/04/2021	NEFT	1,00,000
02	01/05/2021	NEFT	1,00,000
03	01/06/2021	NEFT	1,00,000
04	01/07/2021	NEFT	1,00,000
05	02/08/2021	NEFT	1,00,000
Total			5,00,000/-

C) अमीत आग्रवाल यांच्या बँक खात्यातून आरोपीं गिरीष अग्रवाल याच्या बँक खात्यामध्ये ट्रान्सफर झालेल्या रकमेचा तपशील:—

From DCB A/c 00410200001403 to Girish Agarwal Account			
Sr. No	Date	Transaction details (Narration)	Amount
01	01/01/2022	NEFT	1,00,000
02	01/02/2022	NEFT	1,00,000
03	02/03/2022	NEFT	1,00,000
Total			3,00,000/-

From PNB A/c 10452191004874 to Girish Agarwal Account			
Sr. No	Date	Transaction details (Narration)	Amount
01	04/09/2021	NEFT	1,00,000
02	01/10/2021	NEFT	1,00,000
03	01/11/2021	NEFT	1,00,000
04	01/12/2021	NEFT	1,00,000
05	02/04/2022	NEFT (Amit A/C entry 31/03/2022)	1,00,000
Total			5,00,000/-

A	13,45,036
B	13,93,250
C	8,00,000
Total	35,38,286

A) सुप्रिम ट्रान्सपोर्ट कंपनीच्या बँक खात्यातुन आरोपीं समीक्षा अग्रवाल हिच्या बँक खात्यामध्ये ट्रान्सफर झालेल्या रकमेचा तपशील:—

From HDFC Bank A/c No 0407284000053 to Samixa Agarwal Account			
Sr. No	Date	Transaction details (Narration)	Amount
01	16/01/2020	Salary	43,970/-
02	20/01/2020	Salary	43,970
03	28/01/2020	Salary	43,970
04	31/01/2020	Salary	43,970
05	08/02/2020	Salary	43,970
06	18/02/2020	Salary	43,970
07	29/02/2020	Salary Difference	6180
08	06/03/2020	Salary	45,000
09	11/03/2020	Salary	45,000
10	15/03/2020	Salary	45,000
11	17/03/2020	Salary	45,000
12	21/03/2020	Salary	45,000
13	24/03/2020	Salary	45,000
		Total	5,40,000/-

From HDFC Bank A/c No 0330284000014 to Samixa Agarwal Account			
Sr. No	Date	Transaction details (Narration)	Amount
01	14/08/2018	Salary	43,970
		Total	43,970/-

PNB A/c No 10451131002901 to Samixa Agarwal Account			
Sr. No	Date	Transaction details (Narration)	Amount
01	01/05/2022	NEFT	98,000
02	01/06/2022	NEFT	99,000
03	06/07/2022	NEFT	99,000
		Total	2,96,000/-

B) संगीता एव्हीएशन कंपनीच्या बँक खात्यातुन आरोपीं समीक्षा अग्रवाल हिच्या बँक खात्यामध्ये ट्रान्सफर झालेल्या रकमेचा तपशील:—

From PNB (Sangeeta) to Samixa Agarwal Account			
Sr. No	Date	Transaction details (Narration)	Amount
01	01/05/2021	NEFT	1,00,000
02	02/04/2021	NEFT	1,00,000
03	31/03/2021	RTGS	5,95,500
		Total	7,95,500/-

From DCB A/c No 00421300002745 to Samixa Agarwal Account			
Sr. No	Date	Transaction details (Narration)	Amount
01	01/06/2021	NEFT	1,00,000
02	01/07/2021	NEFT	1,00,000
03	02/08/2021	NEFT	1,00,000
		Total	3,00,000/-

C) अमीत अगरवाल यांच्या बँक खात्यातुन आरोपीं समीक्षा अगरवाल हिच्या बँक खात्यामध्ये ट्रान्सफर झालेल्या रकमेचा तपशील:-

From DCB A/c No 00410200001403 to Samixa Agarwal Account			
Sr. No	Date	Transaction details (Narration)	Amount
01	01/01/2022	NEFT	1,00,000
02	01/02/2022	NEFT	1,00,000
03	03/03/2022	NEFT	1,00,000
		Total	3,00,000/-

From PNB A/c No 10452191004874 to Samixa Agarwal Account			
Sr. No	Date	Transaction details (Narration)	Amount
01	04/09/2021	NEFT	1,00,000
02	01/10/2021	NEFT	1,00,000
03	01/11/2021	NEFT	1,00,000
04	01/12/2021	NEFT	1,00,000
05	02/04/2022	NEFT (Amit A/c Entry 31/03/2022)	1,00,000
		Total	5,00,000/-

A	08,79,970
B	10,95,500
C	8,00,000
Total	27,75,470

A) सुप्रिम ट्रान्सपोर्ट कंपनीच्या बँक खात्यातुन आरोपीं पिंगी आग्रवाल हिच्या बँक खात्यामध्ये ट्रान्सफर झालेल्या रकमेचा तपशील:-

From HDFC Bank A/c No 0407284000053 to Pinky Agarwal Account			
Sr. No	Date	Transaction details (Narration)	Amount
01	16/01/2020	Salary	43,970
02	20/01/2020	Salary	43,970
03	28/01/2020	Salary	43,970
04	31/01/2020	Salary	43,970
05	08/02/2020	Salary	43,970
06	18/02/2020	Salary	43,970
07	29/02/2020	Salary Different	6180
08	06/03/2020	Salary	45,000
09	11/03/2020	Salary	45,000
10	15/03/2020	Salary	45,000
11	17/03/2020	Salary	45,000
12	24/03/2020	Salary	45,000
13	26/03/2021		3,00,000
		Total	7,95,000/-

From PNB A/c No 10451131002901 to Pinky Agarwal Account			
Sr. No	Date	Transaction details (Narration)	Amount
01	01/05/2022	NEFT	98,000
02	01/06/2022	NEFT	99,000
03	06/07/2022	NEFT	99,000
		Total	2,96,000/-

From HDFC Bank A/c No 03302840000140 to Pinky Agarwal Account			
Sr. No	Date	Transaction details (Narration)	Amount
01	14/08/2018	Salary	43,970
		Total	43,970/-

B) संगीता एव्हीएशन कंपनीच्या बँक खात्यातुन आरोपीं पिंगी आग्रवाल हिच्या बँक खात्यामध्ये ट्रान्सफर झालेल्या रकमेचा तपशील:-

From PNB (Sangeeta) to Pinky Agarwal Account			
Sr. No	Date	Transaction details (Narration)	Amount
01	31/03/2021	RTGS	3,77,150
02	02/04/2021	NEFT	1,00,000
03	01/05/2021	NEFT	1,00,000
		Total	5,77,150/-

From DCB A/c No 00421300002745 to Pinky Agarwal Account			
Sr. No	Date	Transaction details (Narration)	Amount
01	01/06/2021	NEFT	1,00,000
02	01/07/2021	NEFT	1,00,000
03	02/08/2021	NEFT	1,00,000
		Total	3,00,000/-

C) अमीत आग्रवाल यांच्या बँक खात्यातून आरोपीं पिकी आग्रवाल हिच्या बँक खात्यामध्ये ट्रान्सफर झालेल्या रकमेचा तपशील:-

From DCB A/c No 00410200001403 to Pinky Agarwal Account			
Sr. No	Date	Transaction details (Narration)	Amount
01	01/01/2022	NEFT	1,00,000
02	01/02/2022	NEFT	1,00,000
03	01/09/2021	NEFT	1,00,000
04	02/03/2022	NEFT	1,00,000
		Total	4,00,000/-

From PNB A/c No 10452191004874 to Pinky Agarwal Account			
Sr. No	Date	Transaction details (Narration)	Amount
01	01/10/2021	NEFT	86,611
02	01/11/2021	NEFT	1,00,000
03	01/12/2021	NEFT	1,00,000
04	02/04/2022	NEFT	1,00,000
		Total	3,86,611/-

A	11,34,970
B	8,77,150
C	7,86,611
Total	27,98,731

A) सुप्रिम ट्रान्सपोर्ट कंपनीच्या बँक खात्यातुन आरोपीं स्वप्नील चव्हाण याच्या बँक खात्यामध्ये ट्रान्सफर झालेल्या रकमेचा तपशील:—

Nil

B) संगीता एव्हीएशन कंपनीच्या बँक खात्यातुन आरोपीं स्वप्नील चव्हाण याच्या बँक खात्यामध्ये ट्रान्सफर झालेल्या रकमेचा तपशील:—

From DCB Bank A/c No 00421300002745 to Swapnil Chavan Account			
Sr. No	Date	Transaction details (Narration)	Amount
01	18/03/2021	RTGS	5,00,000
02	18/03/2021	RETGS	10,00,000
03	18/03/2021	NEFT	18,64,000
		Total	33,64,000/-

From City Bank A/c No 0060246114 to Swapnil Chavan Account			
Sr. No	Date	Transaction details (Narration)	Amount
01	15/11/2019	EFT	2,00,000
		Total	2,00,000/-

From HDFC Bank A/c No 50200008133578 to Swapnil Chavan Account			
Sr. No	Date	Transaction details (Narration)	Amount
01	07/09/2021	MC Issued	8,91,000
		Total	8,91,000/-

C) अमीत आग्रवाल यांच्या बँक खात्यातुन आरोपीं स्वप्नील चव्हाण याच्या बँक खात्यामध्ये ट्रान्सफर झालेल्या रकमेचा तपशील:—

From DCB A/c No 00410200001403 to Swapnil Chavan Account			
Sr. No	Date	Transaction details (Narration)	Amount
01	24/12/2021	IMPS	50,000
02	25/12/2021	NEFT	47,400
		Total	97,400/-

A	Nil
B	44,55,000
C	97,400
Total	45,52,400

- A) सुप्रिम ट्रान्सपोर्ट कंपनीच्या बँक खात्यातुन आरोपीं स्नेहा बबन चव्हाण हिच्या बँक खात्यामध्ये ट्रान्सफर झालेल्या रकमेचा तपशील:—

Nil

- B) संगीता एव्हीएशन कंपनीच्या बँक खात्यातुन आरोपीं स्नेहा बबन चव्हाण हिच्या बँक खात्यामध्ये ट्रान्सफर झालेल्या रकमेचा तपशील:—

From DCB Bank A/c No 00421300002745 to Sneha Chavan Account			
Sr. No	Date	Transaction details (Narration)	Amount
01	04/07/2019	RTGS	3,00,000
02	31/08/2019	NEFT	2,00,000
03	15/11/2019	RTGS	2,50,000
04	12/03/2021	NEFT	5,00,000
05	13/03/2021	NEFT	8,32,000
06	16/03/2021	RTGS	17,82,000
		Total	38,64,000/-

From HDFC Bank A/c No 50200008133578 to Sneha Chavan Account			
Sr. No	Date	Transaction details (Narration)	Amount
01	07/09/2021	RTGS	8,91,000
		Total	8,91,000/-

- C) अमीत आग्रवाल यांच्या बँक खात्यातुन आरोपीं स्नेहा बबन चव्हाण हिच्या बँक खात्यामध्ये ट्रान्सफर झालेल्या रकमेचा तपशील:—

Nil

A	Nil
B	47,55,000
C	Nil
Total	47,55,000

- A) सुप्रिम ट्रान्सपोर्ट कंपनीच्या बँक खात्यातुन आरोपी अतुल पांडे याच्या बँक खात्यामध्ये ट्रान्सफर झालेल्या रकमेचा तपशील:-

Nil

- B) संगीता एव्हीएशन कंपनीच्या बँक खात्यातुन आरोपी अतुल पांडे याच्या बँक खात्यामध्ये ट्रान्सफर झालेल्या रकमेचा तपशील:-

From DCB Bank A/c No 00421300002745 to Atul Pandey Account			
Sr. No	Date	Transaction details (Narration)	Amount
01	31/08/2019	NEFT	2,00,000
02	06/09/2019	NEFT	1,00,000
03	09/09/2019	NEFT	1,00,000
04	14/09/2019	NEFT	1,00,000
05	21/10/2019	NEFT	1,50,000
06	23/10/2019	NEFT	50,000
07	14/11/2019	NEFT	50,000
08	15/06/2021	NEFT	1,00,000
09	31/07/2021	NEFT	25,000
10	07/08/2021	NEFT	50,000
Total			9,25,000/-

From HDFC Bank A/c No 50200008133578 to Atul Pandey Account			
Sr. No	Date	Transaction details (Narration)	Amount
01	23/11/2021	NEFT	17,48,000
02	23/11/2021	NEFT	8,91,000
Total			26,39,000/-

- C) अमीत आग्रवाल यांच्या बँक खात्यातुन आरोपी अतुल पांडे याच्या बँक खात्यामध्ये ट्रान्सफर झालेल्या रकमेचा तपशील:-

From DCB A/c No 00410200001403 to Atul Pandey Account			
Sr. No	Date	Transaction details (Narration)	Amount
01	27/08/2021	NEFT	70,000
Total			70,000/-

From PNB A/c No 10452191004874 to Atul Pandey Account			
Sr. No	Date	Transaction details (Narration)	Amount
01	15/12/2021	NEFT	1,00,000
Total			1,00,000/-

A	Nil
B	35,64,000
C	1,70,000
Total	37,34,000

- A) सुप्रिम ट्रान्सपोर्ट कंपनीच्या बँक खात्यातुन आरोपी रजनी पांडे हिच्या बँक खात्यामध्ये ट्रान्सफर झालेल्या रकमेचा तपशील:—

Nil

- B) संगीता एव्हीएशन कंपनीच्या बँक खात्यातुन आरोपी रजनी पांडे हिच्या बँक खात्यामध्ये ट्रान्सफर झालेल्या रकमेचा तपशील:—

From DCB Bank A/c No 00421300002745 to Rajni Pandey Account			
Sr. No	Date	Transaction details (Narration)	Amount
01	09/10/2020	NEFT	3,75,000
02	20/10/2020	NEFT	3,75,000
03	05/12/2020	NEFT	3,50,000
		Total	11,00,000

- C) अमीत अगरवाल यांच्या बँक खात्यातुन आरोपी रजनी पांडे हिच्या बँक खात्यामध्ये ट्रान्सफर झालेल्या रकमेचा तपशील:—

Nil

Total 11,00,000

A	Nil
B	11,00,000
C	Nil
Total	11,00,000

-----

A) सुप्रिम ट्रान्सपोर्ट कंपनीच्या बँक खात्यातुन आरोपीं राजेश अगरवाल याच्या बँक खात्यामध्ये ट्रान्सफर झालेल्या रकमेचा तपशील:—

Nil

B) संगीता एन्हीएशन कंपनीच्या बँक खात्यातुन आरोपीं राजेश अगरवाल याच्या बँक खात्यामध्ये ट्रान्सफर झालेल्या रकमेचा तपशील:—

From DCB A/c No 00421300002745 to Rajesh Agarwal Account			
Sr. No	Date	Transaction details (Narration)	Amount
01	27/02/2019	NEFT	2,20,000
02	04/03/2019	NEFT	1,00,000
03	04/03/2019	NEFT	1,10,000
04	19/03/2019	IMPS	1,00,000
05	19/03/2019	RTGS	5,25,000
06	19/03/2019	NEFT	2,05,438
07	19/03/2019	NEFT	4,00,000
08	19/03/2019	NEFT	1,00,000
09	22/03/2019	NEFT	1,67,678
10	22/03/2019	NEFT	5,00,000
11	22/03/2019	RTGS	2,50,000
12	10/04/2019	NEFT	2,00,000
13	06/05/2019	NEFT	1,00,000
14	09/05/2019	NEFT	5,00,000
15	03/06/2019	IMPS	15,000
16	01/07/2019	IMPS	50,000
17	04/07/2019	NEFT	3,00,000
18	04/07/2019	IMPS	2,00,000
19	26/07/2019	RTGS	3,00,000
20	02/08/2019	RTGS	3,00,000
21	21/08/2019	NEFT	1,00,000
22	31/08/2019	NEFT	1,75,000
23	06/09/2019	IMPS	1,50,000
24	06/09/2019	NEFT	15,00,000
25	21/10/2019	NEFT	10,00,000
26	08/11/2019	NEFT	3,00,000
27	13/11/2019	NEFT	4,00,000
28	30/11/2019	NEFT	1,00,000
29	04/12/2019	NEFT	2,40,000
30	20/12/2019	NEFT	40,000
31	09/01/2020	IMPS	10,000
32	03/02/2020	NEFT	50,000

33	04/02/2020	NEFT	25,000
34	24/02/2020	NEFT	30,000
35	11/03/2020	NEFT	50,000
36	07/05/2020	NEFT	6,000
37	05/08/2020	NEFT	2,36,312
38	04/09/2020	NEFT	30,000
		Total	90,85,428/-

C) अमीत आग्रवाल यांच्या बँक खात्यातून आरोपी राजेश अगरवाल याच्या बँक खात्यामध्ये ट्रान्सफर झालेल्या रकमेचा तपशील:—

Nil

A	Nil
B	90,85,428
C	Nil
Total	90,85,428

A) सुप्रिम ट्रान्सपोर्ट कंपनीच्या बँक खात्यातुन आरोपी बालाजी एंटरप्रायझेसच्या बँक खात्यामध्ये ट्रान्सफर झालेल्या रकमेचा तपशील:—

Nil

B) संगीता एव्हीएशन कंपनीच्या बँक खात्यातुन आरोपी बालाजी एंटरप्रायझेसच्या बँक खात्यामध्ये ट्रान्सफर झालेल्या रकमेचा तपशील:—

From DCB A/c No 00421300002745 to Balaji Enterprises Account			
Sr. No	Date	Transaction details (Narration)	Amount
01	04/07/2019	RTGS	2,50,000
02	05/07/2019	NEFT	2,50,000
03	16/08/2019	NEFT	3,20,960
04	21/08/2019	NEFT	20,000
05	21/08/2019	NEFT	1,80,000
06	06/09/2019	NEFT	4,60,200
07	06/09/2019	NEFT	7,78,249
08	23/10/2019	NEFT	3,00,000
09	30/11/2019	NEFT	1,55,350
		Total	27,14,759

C) अमीत अग्रवाल यांच्या बँक खात्यातुन आरोपी राजेश अग्रवाल यांच्या बँक खात्यामध्ये ट्रान्सफर झालेल्या रकमेचा तपशील:—

Nil

A	Nil
B	27,14,759
C	Nil
Total	27,14,759

आरोपीनिहाय अपहारीत रकमेची समरी

अ.क्र	आरोपीचे नाव	सुप्रीम ट्रान्सपोर्ट (A)	संगीता एन्हीएशन (B)	अमीत अगरवाल (C)	एकुण
०१	विमल अगरवाल	२,०१,४२,१४८	५,००,०००	४,००,०००	२,१०,४२,१४८/-
०२	नुपुर अगरवाल	१८,९१,४५६	८,१७,६००	८,००,०००	३५,०९,०५६/-
०३	गिरीष अगरवाल	१३,४५,०३६	१३,९३,२५०	८,००,०००	३५,३८,२८६/-
०४	समीक्ष अकरवाल	८,७९,९७०	१०,९५,५००	८,००,०००	२७,७५,४७०/-
०५	पिंकी अगरवाल	११,३४,९७०	८,७७,१५०	७,८६,६११	२७,९८,७३१/-
०६	स्वप्नील चव्हाण	—	४४,५५,०००	९७,४००	४५,५२,४००/-
०७	स्नेहा चव्हाण	—	४७,५५,०००	—	४७,५५,०००/-
०८	अतुल पांडे	—	३५,६४,०००	१,७०,०००	३७,३४,०००/-
०९	रजनी पांडे	—	११,००,०००	—	११,००,०००/-
१०	राजेश अगरवाल	—	९०,८५,४२८	—	९०,८५,४२८/-
११	बालाजी एटरप्रायझेस	—	२७,१४,७५९	—	२७,१४,७५९/-
				एकुण	५,९५,६५,२८३/-

Axisb/Andherieast/2023-24

Date: 23.6.23

To,  
Shri.Sandeep Shinde  
Asst. Police Inspector  
Sahar Police Station,  
Mumbai

Sub: Confirmation of attached letter from Sangeeta Aviation.

Dear Sir,

With respect to your letter dated 22.6.2023 seeking confirmation of receipt of a letter from Sangeeta Aviation issued to Axis Bank Ltd for intimation of funds transfer in account of Mr. Swapnil Baban Chavan A/c # 921010008877100 dated 22.03.2021, we would like to confirm that since the copy of the letter attached does not have any acknowledgement from Axis Bank, it is difficult to ascertain whether it was submitted to us or not. Hence, we cannot confirm on the same. Also we do not ask for such intimations from the third party.

For Axis Bank Ltd.

Authorized Signatory.

**SHRUTI TRIVEDI**  
**AVP & Operations Head**  
**Andheri (E) Branch (SOL-328)**  
Emp. No. 30200. S.S. No. 1810





सह्यार पोलीस ठाणे, मुंबई.  
Sahar Police Station, Mumbai.

Near Indian Oil Depot. Opp. Hotel ITC Grand Maratha,  
Sahar Road, Andheri (E), Mumbai-400099.  
Phone No.: 022-26829783, 26817485, Fax No. 022-26829784,  
E-mail: [ps.sahar.mum@mahapolice.gov.in](mailto:ps.sahar.mum@mahapolice.gov.in).

O.W. No. 2546/2023

Date: - 26/04/2023

**ORDER UNDER SEC. 102 &91 OF CRIMINAL PROCEDURE CODE, 1973**

To,

The Manager,  
HDFC Bank Limited  
Mumbai

**Sub.: Order to Debit freeze the account and produce documents  
under section 102 &91 CrPC.**

**Ref: Sahar Police Station, Mumbai, FIR No 155/2023  
Under Section 120(b), 408,409,477(a),420, 34 of IPC.**

**WHEREAS**, the above mentioned case is presently being investigated by the undersigned and,

**WHEREAS** it is reported during the investigation of the case that various accounts were opened by the accused persons with your bank, details of which are as under.

Sr. No	A/C No.	A/C Name
01	02721000019875	Vimal Agarwal
02	02721000018984	Nupur Agarwal
03	02721000019892	Girish Agarwal
04	02721000070214	Samixa Agarwal
05	02721000055437	Pinky Agarwal
06	12111140000459	Atul Pandey

**WHEREAS** during course of investigation it is disclosed that the above accounts were used by the accused persons for the purpose of siphoning off the proceeds of crime.

**WHEREAS** there is possibility of that the proceeds of crime is still deposited in the above accounts and therefore it is necessary that these accounts must be put under DEBIT FREEZE

**WHEREAS**, the following documents are required for the purpose of investigation of this case, you are hereby directed to produce or cause to be produced the following documents before the undersigned on 04.05.2023 at 11.00hrs at this office **without fail**.

1. Account Opening Forms, Specimen Signature Cards and updated Statements of Accounts from the date of opening till date of all bank accounts in the name of Vimal Agarwal, Nupur Agarwal, Girish Agarwal, Samixa Agarwal, Pinky Agarwal & Atul Pandey and their family members namely

2. Details of all Bank Lockers/FDR held by the above said persons in Bank.

3. All cheques, vouchers, instructions given by the above mentioned account holders regarding deposits/withdrawals/transfers of funds from/to the above said accounts of the above said persons.

4. Any other document found to be relevant with the bank accounts of the above said persons in Bank.

In view of the above you are therefore directed to debit freeze the aforesaid accounts instantly on receipt of this notice and inform this office immediately.

In case of any clarification, you may contact the undersigned over mobile No.9870285010.



*Sandeep Shinde*

(Sandeep Shinde)

Asst. Police Inspector &  
Investigation Officer,  
Sahar Police Station, Mumbai.

Copy submitted to

1) The Metropolitan Magistrate, court room No 63, Andheri Court, Mumbai.

Copy to

Mr. Vimal Agarwal, Mrs. Nupur Agarwal, Mr. Girish Agarwal, Mrs. Samixa Agarwal, Smt. Pinky Agarwal, & Mr. Atul Pandey

Email

SAHAR POLICE STATION

---

**Order to debit freeze of HDFC Accounts**

**From :** SAHAR POLICE STATION  
<ps.sahar.mum@mahapolice.gov.in>

Wed, Apr 26, 2023 03:37 PM

 1 attachment

**Subject :** Order to debit freeze of HDFC Accounts

**To :** lea communication <lea.communication@hdfcbank.com>

Please see our letter attached herewith

Regards  
(Sandeep Shinde)  
Asst. Police Inspector  
Sahar Police Station, Mumbai



---

 **Letter for Debit Freet.pdf**  
826 KB





सहार पोलीस ठाणे, मुंबई.  
**Sahar Police Station, Mumbai.**

Near Indian Oil Depot. Opp. Hotel ITC Grand Maratha,  
Sahar Road, Andheri (E), Mumbai-400099.  
Phone No.: 022-26829783, 26817485, Fax No. 022-26829784,  
E-mail: [ps.sahar.mum@mahapolice.gov.in](mailto:ps.sahar.mum@mahapolice.gov.in).

O.W. No. 2850/2023

Date: - 26/04/2023

**ORDER UNDER SEC. 102 & 91 OF CRIMINAL PROCEDURE CODE, 1973**

To,  
The Manager,  
Axis Bank Limited  
Mumbai

**Sub.: Order to Debit freeze the account and produce documents  
under section 102 & 91 CrPC.**

**Ref: Sahar Police Station, Mumbai, FIR No 155/2023  
Under Section 120(b), 408, 409, 477(a), 420, 34 of IPC.**

WHEREAS, the above mentioned case is presently being investigated by the undersigned and,

WHEREAS it is reported during the investigation of the case that various accounts were opened by the accused persons with your bank, details of which are as under.

Sr. No	A/C No.	A/C Name
01	921010008877100	Swapnil Baban Chavan

WHEREAS, during course of investigation it is disclosed that the above accounts were used by the accused persons for the purpose of siphoning off the proceeds of crime.

WHEREAS there is possibility of that the proceeds of crime is still deposited in the above accounts and therefore it is necessary that these accounts must be put under DEBIT FREEZE

NO LOCKER.  
NO FDR  
IN A/C UNF

STATEMENT  
AND  
ACCOUNT OPENING  
FORM  
PROVIDED.  
AS 26/4/2023



AS ON  
26/4/2023  
13:42  
PM

**WHEREAS**, the following documents are required for the purpose of investigation of this case, you are hereby directed to produce or cause to be produced the following documents before the undersigned on 04.05.2023 at 11.00hrs at this office **without fail**.

1. Account Opening Forms, Specimen Signature Cards and updated Statements of Accounts from the date of opening till date of all bank accounts in the name of Swapnil Baban Chavan and his family members namely

2. Details of all Bank Lockers/FDR held by the above said persons in Bank

3. All cheques, vouchers, instructions given by the above mentioned account holders regarding deposits/withdrawals/transfers of funds from/to the above said accounts of the above said persons.

4. Any other document found to be relevant with the bank accounts of the above said persons in Bank

In view of the above you are therefore directed to debit freeze the aforesaid accounts instantly on receipt of this notice and inform this office immediately.

In case of any clarification, you may contact the undersigned over mobile No.9870285010.



(Sandeep Shinde)

Asst. Police Inspector &  
Investigation Officer,  
Sahar Police Station, Mumbai.

Copy submitted to

1) The Metropolitan Magistrate, court room No 63, Andheri Court, Mumbai.

Copy to

1) Mr. Swapnil Baban Chavan



**Name:** Swapnil Baban Chavan

**Date Of Birth:** 14/11/1988

**Gender:** M

**UID No:** xxxxxxxx4435

**Address Line 1:** S/O: Baban Chavan, Chavan  
House, Marol Marosh

**Address Line 2:** i Road, Marol

**Address Line 3:**

**Landmark:** Opp-I.C.I.C.I Bank

**Pincode:** 400059

**City:** Mumbai Suburban

**State:** Maharashtra

**Country:** INDIA



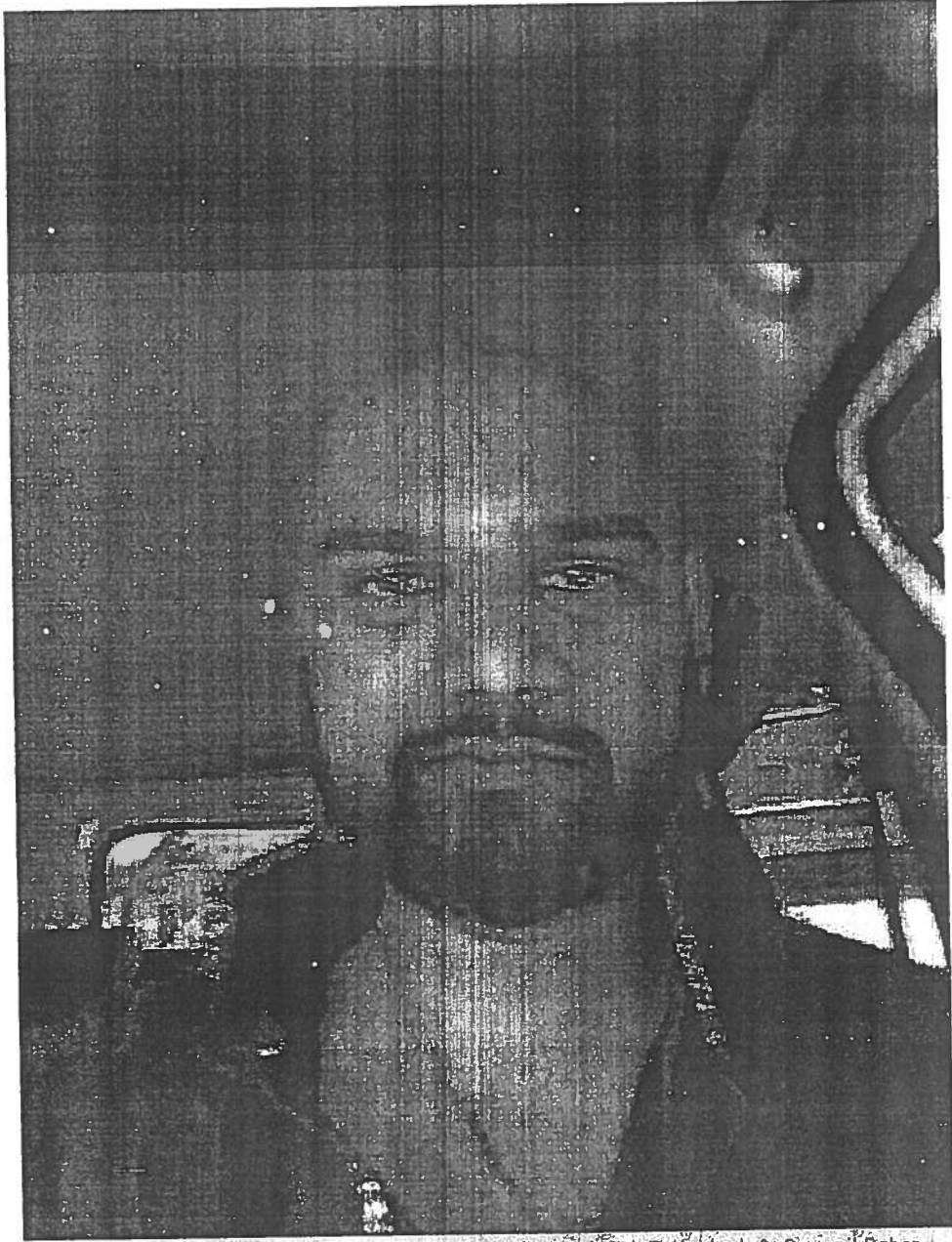

Emp ID: 278646 | E: Neetu | G: Swápníl Baban ...  
18 Mar 21 - 02:59 PM

**Name:** Swapnil Baban Chavan

**Date Of Birth:** 14/11/1988

**Gender:** M

**UID No:** xxxxxxxx4435

**Address Line 1:** S/O: Baban Chavan, Chavan House, Marol Maroshi.

**Address Line 2:** Road, Marol

**Address Line 3:**

**Landmark:** Opp-10, C.I Bank

**Pincode:** 400059

**City:** Mumbai Suburban

**State:** Maharashtra

**Country:** INDIA





**SWAPNIL BABAN CHAVAN**

Joint Holder :-

S/O: BABAN CHAVAN, CHAVAN HOUSE, MAROL MAROSH  
I ROAD, MAROL  
,MUMBAI SUBURBANOPP-I.C.I.C.I BANK  
MUMBAI  
MAHARASHTRA-INDIA  
400059

Customer ID :904905620  
IFSC Code :UTIB0000328  
MICR Code :400211029  
Nominee Registered : N

Registered Mobile No :XXXXXXX7096  
Registered Email ID:S.XXXX4N@GMAIL.COM  
Scheme :EASYACCESS SAVINGS ACCOUNT

PAN :AJDPC8248C

**Statement of Axis Account No :921010008877100 for the period (From : 01-02-2021 To : 31-01-2022)**

Tran Date	Chq No	Particulars	Debit	Credit	Balance	Init. Br
		<b>OPENING BALANCE</b>			<b>.00</b>	
16-03-2021		ACCFUND-LEdVlspOMsrOt6MN-16032021231017		590.00	590.00	100
17-03-2021		Dr Card Charges ISSUE 4317XXXXXXXXX9337	590.00		.00	328
18-03-2021		RTGS/DCBLH21077003025/SANGEETA/DEVELOPME/URGENT		500000.00	500000.00	248
18-03-2021		RTGS/DCBLH21077009585/SANGEETA/DEVELOPME/test6/		1000000.00	1500000.00	248
18-03-2021		NEFT/000001077014/SANGEET/DCB BAN/URGENT		1864000.00	3364000.00	248
31-03-2021	730763	BRN-TO CASH CASH/ANDHERI(E), MUMBAI [MH]	2000000.00		1364000.00	328
31-03-2021		CASH TRANSACTION CHARGES	10620.00		1353380.00	328
31-03-2021		921010008877100:Int.Pd:12-03-2021 to 31-03-2021		3706.00	1357086.00	328
05-04-2021	730765	SAK/CASH WDL/SAK231499903/328/ANDHERI(E/SELF	200000.00		1157086.00	328
06-04-2021	730766	SAK/CASH WDL/SAK231744154/328/ANDHERI(E/SELF	200000.00		957086.00	328
08-04-2021	730770	SAK/CASH WDL/SAK232254362/328/ANDHERI(E/SELF	200000.00		757086.00	328
08-04-2021	730767	SAK/CASH WDL/SAK232265780/328/ANDHERI(E/SELF	200000.00		557086.00	328
08-04-2021	730768	SAK/CASH WDL/SAK232266218/328/ANDHERI(E/SELF	200000.00		357086.00	328
09-04-2021	730771	SAK/CASH WDL/SAK232476986/328/ANDHERI(E/SELF	200000.00		157086.00	328
12-04-2021	730772	SAK/CASH WDL/SAK232766145/328/ANDHERI(E/SELF	110000.00		47086.00	328
12-04-2021		ATM-CASH-AXIS/AWCW32813/6946/120421/MUMBAI	10000.00		37086.00	328
12-04-2021		ATM-CASH-AXIS/CPRH06411/5061/120421/GREATER MU	10000.00		27086.00	328
12-04-2021		ATM-CASH-AXIS/CPRH06411/5062/120421/GREATER MU	10000.00		17086.00	328
12-04-2021		ATM-CASH-AXIS/CPRH06411/5064/120421/GREATER MU	10000.00		7086.00	328
12-04-2021		ATM-CASH-AXIS/CPRH06411/5065/120421/GREATER MU	7000.00		86.00	328
18-04-2021		GST @18% on Charge	13.12		72.88	328
18-04-2021		Consolidated Charges for A/c	72.88		.00	328
01-07-2021		921010008877100:Int.Pd:01-04-2021 to 30-06-2021		767.00	767.00	328
18-07-2021		GST @18% on Charge	117.00		650.00	328



18-07-2021		Consolidated Charges for A/c	650.00		.00	328
06-09-2021		CLG/000134/040921/HDFC BANK LT		891000.00	891000.00	2567
06-09-2021		BRN-OW RTN CLG: REJECT:134:20-PAYMENT STOPPED BY T	891000.00		.00	2567
01-10-2021		921010008877100:Int.Pd:01-07-2021 to 30-09-2021		1.00	1.00	328
24-10-2021		GST @18% on Charge	.15		.85	328
24-10-2021		Consolidated Charges for A/c	.85		.00	328
		<b>TRANSACTION TOTAL</b>	<b>4260064.00</b>	<b>4260064.00</b>		
		<b>CLOSING BALANCE</b>			<b>.00</b>	

Unless the constituent notifies the bank immediately of any discrepancy found by him/her in this statement of Account, it will be taken that he/she has found the account correct.

The closing balance as shown/displayed includes not only the credit balance and / or overdraft limit, but also funds which are under clearing. It excludes the amount marked as lien, if any. Hence the closing balance displayed may not be the effective available balance. For any further clarifications, please contact the Branch.

We would like to reiterate that, as a policy, Axis Bank does not ask you to part with/disclose/revalidate of your iConnect passord,login id and debit card number through emails OR phone call Further,we would like to reiterate that Axis Bank shall not be liable for any losses arising from you sharing/disclosing of your login id, password and debit card number to anyone. Please co-operate by forwarding all such suspicious/spam emails, if received by you, to customer.service@axisbank.com

With effect from 1st August 2016, the replacement charges for Debit card and ATM card applicable on Current accounts have been revised. To know more about the applicable charges,please visit www.axisbank.com

Deposit Insurance and Credit Guarantee Corporation (DICGC) insurance cover is applicable in all Banks' deposits, such as savings, current, fixed, recurring etc\* up to maximum amount of Rs 5 Lakh including principal & interest both\* (\* or exceptions and details please refer www.dicgc.org.in )

In compliance with regulatory guidelines, the non-CTS cheque books attached to the accounts would be destroyed in banks core banking System. Thus, Non CTS cheques will not be valid for CASH, Clearing and Transfer transactions

REGISTERED OFFICE - AXIS BANK LTD,TRISHUL,Opp. Samartheswar Temple, Near Law Garden, Ellisbridge, Ahmedabad . 380006.This is a system generated output and requires no signature.

BRANCH ADDRESS - AXIS BANK LTD, ANDHERI(E), MUMBAI [MH], CORPORATE CENTRE,CT271, ANDHERI KURLA ROAD, , 400059, MUMBAI, MAHARASHTRA, INDIA. TEL:022-28224255/56 FAX:28224261

**Legends :**

ICONN - Transaction trough Internet Banking

VMT-ICON - Visa Money Transfer through Internet Banking

AUTOSWEEP - Transfer to linked fixed deposit

REV SWEEP - Interest on Linked fixed Deposit

SWEEP TRF - Transfer from Linked Fixed Deposit / Account

VMT - Visa Money Transfer through ATM

CWDR - Cash Withdrawal through ATM

PUR - POS purchase

TIP/ SCG - Surcharge on usage of debit card at pumps/railway ticket purchase or hotel tips

RATE.DIFF - Difference in rates on usage of card internationally

CLG - Cheque Clearing Transaction

EDC - Credit transaction through EDC Machine

SETU - Seamless electronic fund transfer through AXIS Bank

Int.pd - Interest paid to customer

Int.Coll - Interest collected from the customer



++++ End of Statement +++++



सहारा पोलीस ठाणे, मुंबई.  
Sahar Police Station, Mumbai.

Near Indian Oil Depot. Opp. Hotel ITC Grand Maratha,  
Sahar Road, Andheri (E), Mumbai-400099.  
Phone No.: 022-26829783, 26817485, Fax No. 022-26829784,  
E-mail: [ps.sahar.mum@mahapolice.gov.in](mailto:ps.sahar.mum@mahapolice.gov.in).

O.W. No. 2848/2023

Date: - 26/04/2023

**ORDER UNDER SEC. 102 & 91 OF CRIMINAL PROCEDURE CODE, 1973**

To,  
The Manager,  
Saraswat Bank Limited  
Mumbai

**Sub.: Order to Debit freeze the account and produce documents under section 102 & 91 CrPC.**

**Ref: Sahar Police Station, Mumbai, FIR No 155/2023  
Under Section 120(b), 408, 409, 477(a), 420, 34 of IPC.**

**WHEREAS**, the above mentioned case is presently being investigated by the undersigned and,

**WHEREAS** it is reported during the investigation of the case that various accounts were opened by the accused persons with your bank, details of which are as under.

Sr. No	A/C No.	A/C Name
01	013200128873557	Sneha Baban Chavan

**WHEREAS** during course of investigation it is disclosed that the above accounts were used by the accused persons for the purpose of siphoning off the proceeds of crime.

**WHEREAS** there is possibility of that the proceeds of crime is still deposited in the above accounts and therefore it is necessary that these accounts must be put under DEBIT FREEZE



Recd. by  
26.4.23  
13:03 PM  
Jannu

**WHEREAS**, the following documents are required for the purpose of investigation of this case, you are hereby directed to produce or cause to be produced the following documents before the undersigned on 04.05.2023 at 11.00hrs at this office **without fail**.

1. Account Opening Forms, Specimen Signature Cards and updated Statements of Accounts from the date of opening till date of all bank accounts in the name of Sneha Baban Chavan and her family members namely
2. Details of all Bank Lockers/FDR held by the above said persons in Bank.
3. All cheques, vouchers, instructions given by the above mentioned account holders regarding deposits/withdrawals/transfers of funds from/to the above said accounts of the above said persons.
4. Any other document found to be relevant with the bank accounts of the above said persons in Bank

In view of the above you are therefore directed to debit freeze the aforesaid accounts instantly on receipt of this notice and inform this office immediately.

In case of any clarification, you may contact the undersigned over mobile No.9870285010.



(Sandeep Shinde)

Asst. Police Inspector &  
Investigation Officer,  
Sahar Police Station, Mumbai.

Copy submitted to

- 1) The Metropolitan Magistrate, court room No 63, Andheri Court, Mumbai.

Copy to

- 1) Mrs.Sneha Baban Chavan





सहार पोलीस ठाणे, मुंबई.  
**Sahar Police Station, Mumbai.**

Near Indian Oil Depot. Opp. Hotel ITC Grand Maratha,  
Sahar Road, Andheri (E), Mumbai-400099.  
Phone No.: 022-26829783, 26817485, Fax No. 022-26829784,  
E-mail: [ps.sahar.mum@mahapolice.gov.in](mailto:ps.sahar.mum@mahapolice.gov.in).

O.W. No. 2547/2023

Date: - 26/04/2023

**ORDER UNDER SEC. 102 & 91 OF CRIMINAL PROCEDURE CODE, 1973**

To,  
The Manager,  
ICICI Bank Limited  
Mumbai

**Sub.: Order to Debit freeze the account and produce documents  
under section 102 & 91 CrPC.**

**Ref: Sahar Police Station, Mumbai, FIR No 155/2023  
Under Section 120(b), 408, 409, 477(a), 420, 34 of IPC.**

**WHEREAS**, the above mentioned case is presently being investigated by the undersigned and,

**WHEREAS** it is reported during the investigation of the case that various accounts were opened by the accused persons with your bank, details of which are as under.

Sr. No	A/C No.	A/C Name
01	104401531869	Swapnil Chavan
02	623501540474	Rajesh Agarwal

**WHEREAS** during course of investigation it is disclosed that the above accounts were used by the accused persons for the purpose of siphoning off the proceeds of crime.

**WHEREAS** there is possibility of that the proceeds of crime is still deposited in the above accounts and therefore it is necessary that these accounts must be put under DEBIT FREEZE

**WHEREAS**, the following documents are required for the purpose of investigation of this case, you are hereby directed to produce or cause to be produced the following documents before the undersigned on 04.05.2023 at 11.00hrs at this office **without fail**.

1. Account Opening Forms, Specimen Signature Cards and updated Statements of Accounts from the date of opening till date of all bank accounts in the name of Swapnil Chavan & Rajesh Agarwal and their family members namely

2. Details of all Bank Lockers/FDR held by the above said persons in Bank.

3. All cheques, vouchers, instructions given by the above mentioned account holders regarding deposits/withdrawals/transfers of funds from/to the above said accounts of the above said persons.

4. Any other document found to be relevant with the bank accounts of the above said persons in Bank

In view of the above you are therefore directed to debit freeze the aforesaid accounts instantly on receipt of this notice and inform this office immediately.

In case of any clarification, you may contact the undersigned over mobile No.9870285010.

*Sandeep*

(Sandeep Shinde)

Asst. Police Inspector &  
Investigation Officer,  
Sahar Police Station, Mumbai.

Copy submitted to

1) The Metropolitan Magistrate, court room No 63, Andheri Court, Mumbai.

Copy to

1) Mr. Swapnil Chavan  
2) Mr. Rajesh Agarwal



Priti Naik  
8879658795.

priti.naik@icicibank.com

**Email****SAHAR POLICE STATION****Order to Debit Freeze of ICICI Account**

---

**From :** SAHAR POLICE STATION  
<ps.sahar.mum@mahapolice.gov.in>

Wed, Apr 26, 2023 03:43 PM

 1 attachment

**Subject :** Order to Debit Freeze of ICICI Account

**To :** priti naik <priti.naik@icicibank.com>

Pleas our letter attached herewith

Regards  
(Sandeep Shinde)  
Asst. Police Inspector  
Sahar Police Station, Mumbai

---

 **Letter for Debit Freeze of ICICI Account.pdf**  
808 KB

---



# LASERJET PROFESSIONAL P1100 Printer Series

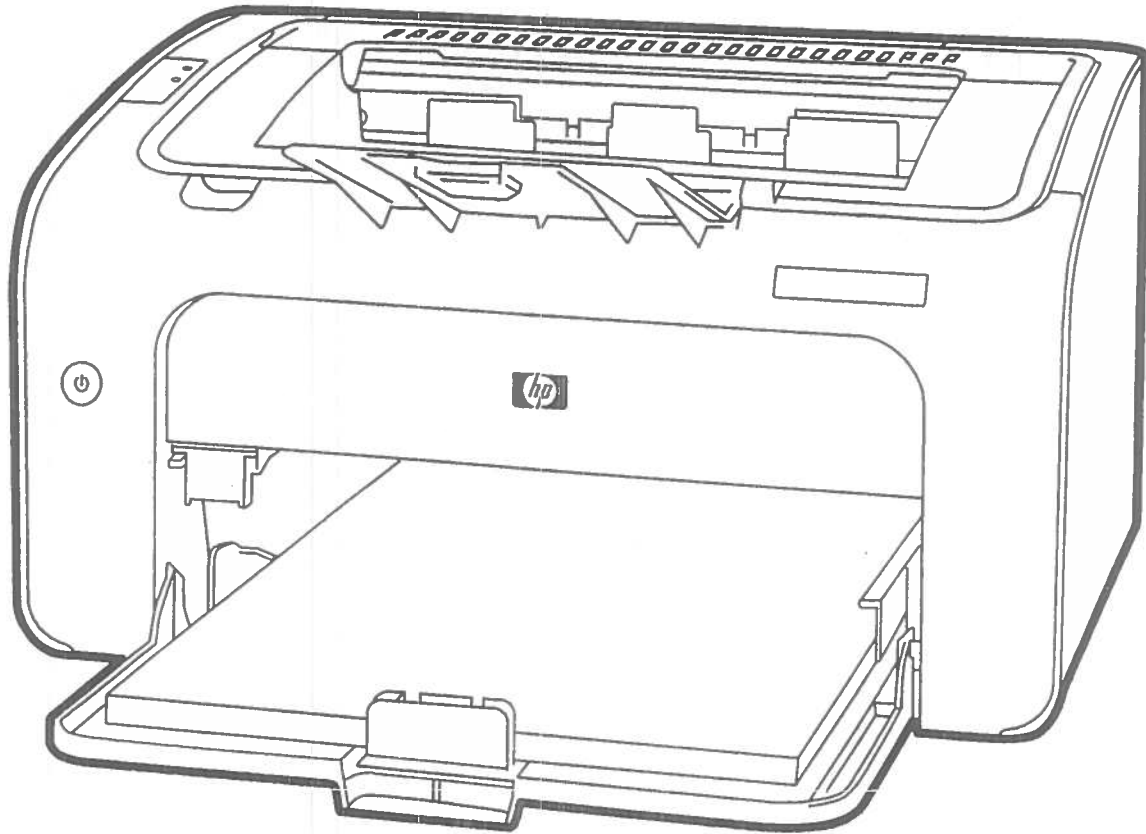

## Simple and Trustworthy

Effortless setup—no CD installation required—using HP Smart Install.<sup>1</sup> Print up to 19 ppm on multiple paper sizes and types—card stock, transparencies and more.

## Performance and Value

Get bold, crisp text and sharp images with HP FastRes 1200 and Original HP toner.

## Environmental Leadership

Reduce your impact on the environment with power-saving features like Instant-on Technology<sup>2</sup> and HP Auto-Off/Auto-On Technology.



Install<sup>1</sup>



up to  
19 PPM/18 PPM



Technology<sup>2</sup>

Auto-Off/Auto-On



Technology

<sup>1</sup> For Windows only

<sup>2</sup> First page out in less than 8.5 seconds



सहार पोलीस ठाणे, मुंबई.

**Sahar Police Station, Mumbai.**

Near Indian Oil Depot. Opp. Hotel ITC Grand Maratha,

Sahar Road, Andheri (E), Mumbai-400099.

Phone No.: 022-26829783, 26817485, Fax No. 022-26829784,

E-mail: [ps.sahar.mum@mahapolice.gov.in](mailto:ps.sahar.mum@mahapolice.gov.in).

O.W. No. 2549/2023

Date: - 26/04/2023

**ORDER UNDER SEC. 102 & 91 OF CRIMINAL PROCEDURE CODE, 1973**

To,  
The Manager,  
Punjab National Bank  
Mumbai

**Sub.: Order to Debit freeze the account and produce documents under section 102 & 91 CrPC.**

**Ref: Sahar Police Station, Mumbai, FIR No 155/2023  
Under Section 120(b), 408, 409, 477(a), 420, 34 of IPC.**

**WHEREAS**, the above mentioned case is presently being investigated by the undersigned and,

**WHEREAS** it is reported during the investigation of the case that various accounts were opened by the accused persons with your bank, details of which are as under.

Sr. No	A/C No.	A/C Name
01	1565000100131966,	Rajni Surendra Pandey

**WHEREAS** during course of investigation it is disclosed that the above accounts were used by the accused persons for the purpose of siphoning off the proceeds of crime.

**WHEREAS** there is possibility of that the proceeds of crime is still deposited in the above accounts and therefore it is necessary that these accounts must be put under DEBIT FREEZE

**WHEREAS**, the following documents are required for the purpose of investigation of this case, you are hereby directed to produce or cause to be produced the following documents before the undersigned on 04.05.2023 at 11.00hrs at this office **without fail**.

1. Account Opening Forms, Specimen Signature Cards and updated Statements of Accounts from the date of opening till date of all bank accounts in the name of Sneha Baban Chavan and her family members namely

2. Details of all Bank Lockers/FDR held by the above said persons in Bank .

3. All cheques, vouchers, instructions given by the above mentioned account holders regarding deposits/withdrawals/transfers of funds from/to the above said accounts of the above said persons.

4. Any other document found to be relevant with the bank accounts of the above said persons in Bank

In view of the above you are therefore directed to debit freeze the aforesaid accounts instantly on receipt of this notice and inform this office immediately.

In case of any clarification, you may contact the undersigned over mobile No.9870285010.

  
(Sandeep Shinde)

Asst. Police Inspector &  
Investigation Officer,  
Sahar Police Station, Mumbai.

Copy submitted to

1) The Metropolitan Magistrate, court room No 63, Andheri Court, Mumbai.

Copy to

1) Mrs.Sneha Baban Chavan



Ramamohan Rao - Sr. mgr

9848634229.

BD1565@pnb.co.in.

**Email**

---

**Order to Debit Freeze of PNB Account**

---

Wed, Apr 26, 2023 03:46 PM

**From :** SAHAR POLICE STATION  
<ps.sahar.mum@mahapolice.gov.in>

📎 1 attachment

**Subject :** Order to Debit Freeze of PNB Account

**To :** bo1565@pnb.co.in

Pleas our letter attached herewith

Regards  
(Sandeep Shinde)  
Asst. Police Inspector  
Sahar Police Station, Mumbai

---

 **Letter for Debit Freeze of PNB Account.pdf**  
747 KB

---



# LASERJET PROFESSIONAL P1100 Printer Series

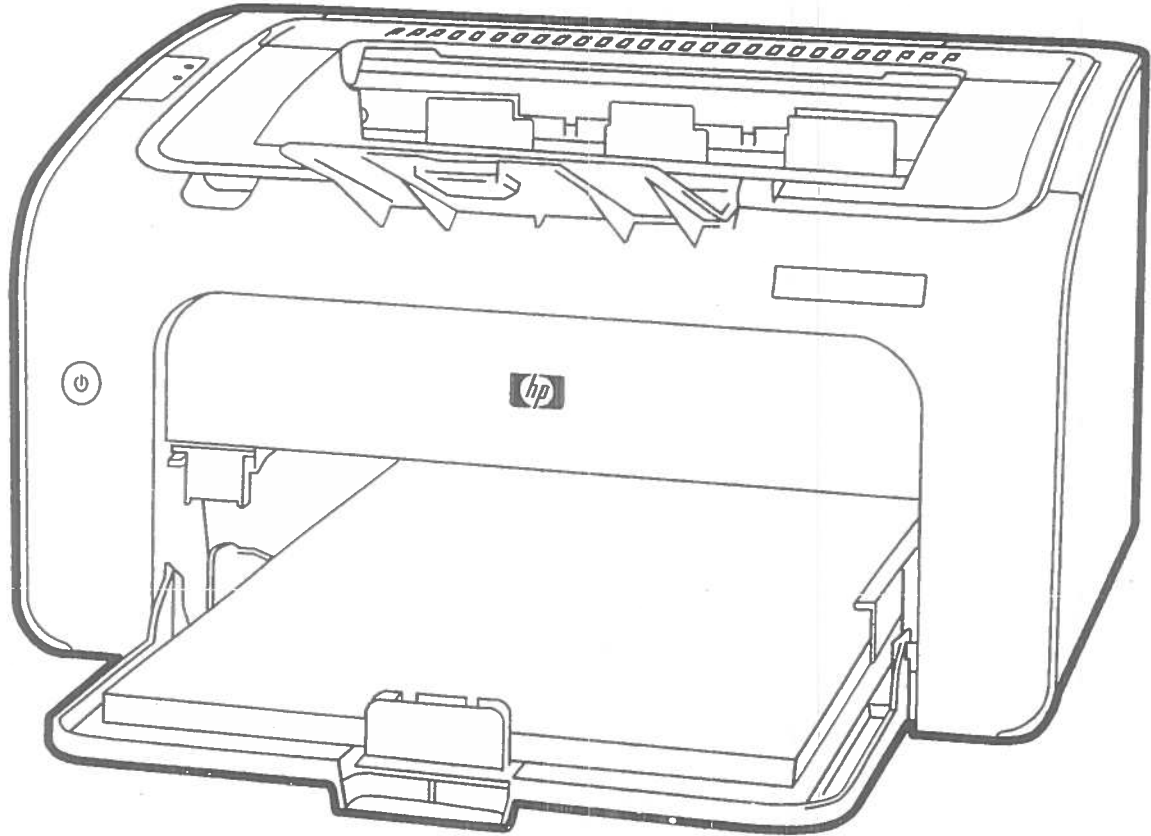

## Simple and Trustworthy

Effortless setup—no CD installation required—using HP Smart Install.<sup>1</sup> Print up to 19 ppm on multiple paper sizes and types—card stock, transparencies and more.

## Performance and Value

Get bold, crisp text and sharp images with HP FastRes 1200 and Original HP toner.

## Environmental Leadership

Reduce your impact on the environment with power-saving features like Instant-on Technology<sup>2</sup> and HP Auto-Off/Auto-On Technology.



Install<sup>1</sup>



up to  
19 PPM/18 PPM



Technology<sup>2</sup>

Auto-Off/Auto-On



Technology

<sup>1</sup> For Windows only

<sup>2</sup> First page out in less than 8.5 seconds



सहारा पोलीस ठाणे, मुंबई.  
Sahar Police Station, Mumbai.

Near Indian Oil Depot. Opp. Hotel ITC Grand Maratha,  
Sahar Road, Andheri (E), Mumbai-400099.  
Phone No.: 022-26829783, 26817485, Fax No. 022-26829784,  
E-mail: [ps.sahar.mum@mahapolice.gov.in](mailto:ps.sahar.mum@mahapolice.gov.in).

O.W. No. ३९४ | /2023

Date:- 06/07/2023

प्रति,

मा. आयुक्त  
इनकम टॅक्स भवन  
चर्चगेट, मुंबई-४००००२

विषय :- TDS सर्टीफिकेटची तपासणी होऊन अहवाल मिळणे बाबत.

महोदय,

सहारा पोलीस ठाणे, मुंबई येथे दिनांक २५/०४/२०२३ रोजी गु.र.क्र १५५/२०२३ कलम १२०(ब), ४०८, ४०९, ४७७(अ), ४२०, ३४ भादवि अन्वये गुन्हा नोंद करण्यात आला आहे.

उपरोक्त गुन्हातील अटक आरोपी स्वप्नील बबन चव्हाण याने तपासा दरम्यान पोलीसांना खालील नमुद टी.डी.एस. सर्टीफिकेट सादर केलेले आहेत. तसेच टी.डी.एस कापुन (कपात करुन) तक्रारदार कंपनीने आरोपी स्वप्नील चव्हाण याला रक्कम दिलेली आहे असा दावा केला आहे.

पोलीसांनी सदर टी.एस.सर्टीफिकेटचे अवलोकन केले असता ते खोटे असावेत असा संशय आहे. तरी सदरचे टी.टी.एस. सर्टीफिकेट तपासणी करिता आपले कार्यालयास पाठविण्यात येत आहेत.

1. TDS Certificate, Issued in the name of Swapnil Baba Chavan For Finaincail Yerar 2017-2018
2. TDS Certificate, Issued in the name of Swapnil Baba Chavan For Finaincail Yerar 2018-2019
3. TDS Certificate, Issued in the name of Swapnil Baba Chavan For Finaincail Yerar 2019-2020
4. TDS Certificate, Issued in the name of Swapnil Baba Chavan For Finaincail Yerar 2020-2021

तरी उपरोक्त नमुद चारही टी.डी.एस. सर्टीफिकेटची खालील मुद्या प्रमाणे तपासणी होऊन अहवाल मिळणेस विनंती आहे.

- १) नमुद टी.डी.एस. सर्टीफिकेटची तपासणी करुन ते खरे आहेत किंवा कसे? याबाबतची माहिती देण्यात यावी.
- २) नमुद टी.टी.एस. सर्टीफिकेट मध्ये नमुद करण्यात आलेली रक्कम संगीता एव्हीएशन प्रा लि या कंपनीकडुन (TAN No MUM-80051G) इनकम टॅक्स विभागाला भरलेली आहे किंवा कसे?



आपला विश्वासु

*Sandeep Shinde*  
(संदीप शिंदे)

सहाय्यक पो. निरीक्षक  
सहारा पोलीस ठाणे, मुंबई

BA 567/2023

1

MHCC050034232023



IN THE COURT OF SESSIONS AT DINDOSHI  
(BORIVALI DIVISION), GOREGAON, MUMBAI

CRIMINAL BAIL APPLICATION NO. 567 OF 2023

Mr. Girish Agarwal,

Age : 40 yrs., Occupation :

R/o : Keval Kunj Apartment, Sec. 13,

Rohini, Near D. D. Club,

Delhi : 110 085

..Applicant

Vs

The State of Maharashtra,

( through Sahar Police Station )

..Respondent

Ld. Adv. A.M. Saraogi, for the applicant.

Ld. APP P.K. Mahajan, for the State.

Ld. Adv. Pokharkar, for the intervener.

CORAM : H.H. THE ADDITIONAL SESSIONS JUDGE  
DR. (SMT.) SRISHTY NEELKANTH (C.R.NO.4)

DATE : 19<sup>th</sup> July, 2023

ORDER

This is an application for releasing the applicant on bail, in respect of C. R. No. 155 of 2023 registered with Sahar Police Station, for the offences punishable under Sections 408, 409, 477-A, 420 read with

120(B) and 34 of the Indian Penal Code.

2 At the instance of the informant the aforesaid offence came to be registered.

The facts of the case as appears from the FIR are that :-

The informant is the Chairman and the Executive Director of Supreme Transport Pvt. Ltd. and Sangeeta Aviation Service Pvt. Ltd. Apart from the informant, his father, his younger brother, other co-accused namely Vimal Agarwal and Girish Agarwal ( the applicant herein ) are also the Directors in Supreme Transport Pvt. Ltd. The main business of the said company is road transport and air transport of goods. The company owns some vehicles and aircraft. Apart from this, vehicles are taken on rent basis as required for the business of the company. The main office of the said company is at Mumbai and its branches and divisional offices are at Panvel, Kalamoli, Rajasthan, Gujarat, Delhi and Bangalore. Vimal Agarwal and Girish Agarwal are the cousins of the informant and reside at Bangalore and Delhi respectively. Both of them stay in Mumbai for a few days every month and participate in the day-to-day affairs of the company.

3 Supreme Transport Pvt. Ltd. company is running in loss since 2012. The entire work of both these companies are being looked after from the office situated at Andheri (E). National Company Law Tribunal ( N.C.L.T. ) by an order dated 10.08.2021 had declared Sangeeta Aviation Service Pvt. Ltd. Company as an insolvent. Appeal against the Impugned Order of the N.C.L.T. is subjudice before the Appellate Court. In the year 2014, one of the co-accused namely Varun Ramesh Kakriya was appointed

as an Assistant. In the year 2016, other co-accused Kamlesh Bhairav Tatawat was appointed as Chief Finance Officer and his cousin brother Mukesh Bhairav Tatawat was appointed as Chief Operation Officer in the company of the informant. As the informant had to often go abroad and to various other places in India, therefore, to look after the financial affairs of both the companies, the entire responsibility was handed over to Kamlesh Bhairav Tatawat. The old friends of the informant i.e. Swapnil Chavan and Atul Pandey also used to visit the office of the company.

4 As a CEO of the company, in the month of July 2022, the informant came to know that some amount was to be recovered from Nippon Ltd. Company. Therefore, after issuing several e-mail correspondence, the informant was informed on 26.08.2022 by the officials of Nippon Company Ltd. that on 26.07.2022, they had deposited Rs. 3,22,616/- in the Bank of India account of the company. The informant also came to know that on 27.07.2022, Rs. 3,23,278/- came to be transferred from the said account in the bank account of Vimal Agarwal. After enquiry, the informant came to know that there had been misappropriation of huge amount in the company. The informant, therefore, enquired about the financial transactions of the company through the Chartered Accountant of the company. After getting an Enquiry Report, the informant came to know that the applicant along with other accused had misappropriated total amount of Rs. 6,27,36,180/- by transferring the respective amounts in their accounts through the accounts of the companies. Accordingly, report came to be lodged in the Sahar Police Station.

5           The learned Advocate for the applicant/accused submitted that the applicant/accused has been falsely implicated. By an order dated 10.08.2021, NCLT-III, Mumbai suspended all the Directors and employees of Sangeeta Aviation Service Pvt. Ltd. and the Tribunal had appointed Mr. Bijendra Zha as an Interim Resolution Professional ( IRP ) to carry out the remaining process. Therefore, the informant had no locus/authority to file the present FIR, as all the management and control is vested with IRP. It is further contended that the motive behind filing the present FIR against the present applicant and other accused who all are relatives and family members of the informant and having important positions in the company is to grab all the assets and properties of both the companies and to sell out the same and to run away to another country. It is further contended that the informant was not having any complaint against the present applicant and other accused till the informant was able to sell the properties of the company. After the above order by NCLT had been passed restraining the informant from selling the properties, the present FIR is filed to fulfill the grudges and oblique motives with intention to pressurize and harass them, so that he could sell the properties of the company. It is submitted that the dispute between the parties is pending for adjudication before the NCLT and the present FIR is an abuse of the process of law. Claiming himself to be innocent, the applicant/accused has contended that he is falsely implicated by the informant with oblique motive and to pressurize the applicant/accused. It is further contended that this case is based on documentary evidence where money is alleged to be transferred into the bank account of the applicant without the applicant being entitled

to the same. So, the custodial interrogation of the applicant/accused is not at all required for the same. Further, the applicant does not have any criminal antecedents. The learned advocate for the applicant thus prayed that the applicant/accused was ready to abide by the terms and conditions imposed by the court, so the bail application be allowed.

6 The learned APP opposed the application and submitted that the applicant/accused had contended that he is a director and was also working in the company and the amount received from the bank account of the company by him is as salary and consultancy charges. The amounts of Rs. 13,45,036, Rs. 13,93,250/- and Rs. 8,00,000/- had been transferred to the account of the applicant/accused from the account of Supreme Transport Pvt. Ltd. Company, Sangeeta Aviation Service Pvt. Ltd. and the informant respectively. The said amounts were misappropriated by him. The said amounts are yet to be recovered from the applicant/accused. When the applicant/accused was asked to produce the documents of being an employee of the said company, he did not file the same. The applicant/accused was asked to submit purchase orders received from the company and the bills in exchange for services rendered, but he was not able to produce the said documents. It is further argued that the amount embezzled in the crime is as large as Rs. 6,27,36,180 and it has been found that the accused has prepared a false account to embezzle the said amount and it is revealed that all the accused had formed a pre-planned conspiracy for that. The present applicant's wife is wanted accused in this crime. The wanted accused Rajesh Agarwal had opened a company in the name of Balaji Enterprise. However, the investigation had not revealed any business

of Balaji Enterprise. Therefore, it is concluded from the investigation that the said applicant and the remaining wanted accused had established some fake companies and thereby diverted the money of the informant and his company to the account of this fake company and embezzled it. It is submitted by the learned APP that since the investigation is going on, if the accused is granted bail, there is possibility that he will destroy the evidence of such a fake company and numerous transactions of misappropriation of amount, and the documents fabricated by him in the entire process. Further, there is possibility of absconding, if the accused is granted bail. He thus, prayed that the application be rejected. The informant also resisted the application by filing an intervener application.

7 Heard the learned counsel for the applicant, the learned APP for the State and the intervener.

8 Perused the application, the say filed thereon and the documents relied upon in support thereof.

9 It is seen that the applicant is the cousin brother of the informant and the Director of Supreme Transport Pvt. Ltd. The informant has in the FIR given the particulars of the applicant and all the co-accused regarding the amount which were transferred in their accounts from 2018 to 2022. It is seen from the say filed by the Investigating Officer, that an amount of Rs. 32,98,332/- was transferred in the account of the applicant during the period from 27.02.2019 to 04.09.2020 from the accounts of Sangeeta Aviation Service Pvt. Ltd., Supreme Transport Pvt. Ltd. and

Ameet Agarwal i.e. the informant. It is contended by the applicant that since he was a Director in the company so he was receiving the said amount by way of salary. However, the audit report filed by the Investigating Officer reveals the contrary. It shows that Rs. 62,43,029/- were siphoned off in the account of the applicant. No resolution has been filed that has been passed by the board of directors of both the companies regarding the transferred amount. The investigation prima-facie reveals that the accused had embezzled the said amount.

10 It is the case of the prosecution that the applicant is the close relative of the other co-accused Vimal Agarwal and others. The other family members are alleged to be involved in the crime of misappropriation of huge amounts from the company. The remaining accused who are the relatives of the applicant i.e. Smt. Nupur Agarwal, Samiksha Agarwal and Pinki Agarwal, in the conspiracy of the said crime, are not holding any position in the company of the informant, but it is found that they received money from various accounts of the company four to five times per month in the name of salary and rent. This shows the pre-planned conspiracy of the accused. It has also been found that the money was transferred to the bank accounts of the arrested accused Swapnil Chavan and wanted accused Sneha Chavan, Rajni Pandey and Atul Pandey, when they were not holding any position in the company or had rendered any kind of service to the company. Amongst the bank accounts of the informant and the companies i.e. Supreme Transport Pvt. Ltd. and Sangeeta Aviation Service Pvt. Ltd., the access ( authorized signatory ) of HDFC bank accounts was with accused Vimal and Girish, while the access ( authorized signatory ) of

the rest of the bank accounts was with Kamlesh Tatawat, the CFO of the company. From this, the investigation has revealed that the accused Vimal and Girish had embezzled a large amount of money in a pre-planned conspiracy with accused Kamlesh.

11 The offence is purely economic in nature. Serious allegations of misappropriation of Rs. 35,38,286/- is made against the applicant himself. The investigation is still in progress. From the documents filed on record prima-facie it is seen that the applicant was involved in the commission of the crime. There are prima-facie ingredients of fabrication of documents. This entire case is based on documentary evidence. The possibility of tampering with the evidence cannot be ruled out, if the applicant is released on bail. Hence, the following order is passed :

**ORDER**

Criminal Bail Application No. 567 of 2023 is hereby rejected and disposed of accordingly.

(DR. (SMT.) SRISHTY NEELKANTH )  
Additional Sessions Judge,  
City Civil Court, Borivali Division,  
Dindoshi, Goregaon, Mumbai.

Date : 19/07/2023

Dictated on Computer : 19/07/2023  
Checked & Corrected on : 21/07/2023  
Sign on : 21/07/2023

CERTIFIED TO BE TRUE AND CORRECT COPY OF THE ORIGINAL SIGNED JUDGMENT/ORDER."

24/07/2023 at 11.08 a.m.  
UPLOAD DATE AND TIME

Mrs. S.B. Vichare  
NAME OF STENOGRAPHER

Name of Judge (with Court room no.)	HHJ Dr. (Smt) Srishty Neelkanth City Civil & Sessions Court, Borivali Div., Dindoshi, Mumbai ( C.R.No. 04 )
Date of Pronouncement of JUDGEMENT/ORDER	19/07/2023
JUDGEMENT/ORDER signed by P.O. on	21/07/2023
JUDGEMENT/ORDER uploaded on	24/07/2023

BA 570/2023

1

MHCC050034452023



IN THE COURT OF SESSIONS AT DINDOSHI  
(BORIVALI DIVISION), GOREGAON, MUMBAI

CRIMINAL BAIL APPLICATION NO. 570 OF 2023

Swapnil Baban Chavan,  
Adult, Indian Inhabitant,  
Age : 34 yrs., Occupation : Consultant,  
R/o : Chohan House, Marol Maroshi Road,  
Andheri East, Mumbai.

..Applicant

Vs

1) The State of Maharashtra,  
2) The Inspector of Police,  
( through Sahar Police Station )

..Respondent

Ld. Adv. S.S. Gandhi, for the applicant.  
Ld. APP P.K. Mahajan, for the State.  
Ld. Adv. Pokharkar, for the intervener.

CORAM : H.H. THE ADDITIONAL SESSIONS JUDGE  
DR. (SMT.) SRISHTY NEELKANTH (C.R.NO.4)

DATE : 19<sup>th</sup> July, 2023

ORDER

This is an application for releasing the applicant on bail, in respect of C. R. No. 155 of 2023 registered with Sahar Police Station, for the offences punishable under Sections 408, 409, 477-A, 420 read with

120(B) and 34 of the Indian Penal Code.

2 At the instance of the informant the aforesaid offence came to be registered.

The facts of the case as appears from the FIR are that :-

The informant is the Chairman and the Executive Director of Supreme Transport Pvt. Ltd. and Sangeeta Aviation Service Pvt. Ltd. Apart from the informant, his father, his younger brother, other co-accused namely Vimal Agarwal and Girish Agarwal are also the Directors in Supreme Transport Pvt. Ltd. The main business of the said company is road transport and air transport of goods. The company owns some vehicles and aircraft. Apart from this, vehicles are taken on rent basis as required for the business of the company. The main office of the said company is at Mumbai and its branches and divisional offices are at Panvel, Kalamboli, Rajasthan, Gujarat, Delhi and Bangalore. Vimal Agarwal and Girish Agarwal are the cousins of the informant and reside at Bangalore and Delhi respectively. Both of them stay in Mumbai for a few days every month and participate in the day-to-day affairs of the company.

3 Supreme Transport Pvt. Ltd. company is running in loss since 2012. The entire work of both these companies are being looked after from the office situated at Andheri (E). National Company Law Tribunal ( N.C.L.T. ) by an order dated 10.08.2021 had declared Sangeeta Aviation Service Pvt. Ltd. Company as an insolvent. Appeal against the Impugned Order of the N.C.L.T. is subjudice before the Appellate Court. In the year 2014, one of the co-accused namely Varun Ramesh Kakriya was appointed

as an Assistant. In the year 2016, other co-accused Kamlesh Bhairav Tatawat was appointed as Chief Finance Officer and his cousin brother Mukesh Bhairav Tatawat was appointed as Chief Operation Officer in the company of the informant. As the informant had to often go abroad and to various other places in India, therefore, to look after the financial affairs of both the companies, the entire responsibility was handed over to Kamlesh Bhairav Tatawat. The old friends of the informant i.e. Swapnil Chavan and Atul Pandey also used to visit the office of the company.

4 As a CEO of the company, in the month of July 2022, the informant came to know that some amount was to be recovered from Nippon Ltd. Company. Therefore, after issuing several e-mail correspondence, the informant was informed on 26.08.2022 by the officials of Nippon Company Ltd. that on 26.07.2022, they had deposited Rs. 3,22,616/- in the Bank of India account of the company. The informant also came to know that on 27.07.2022, Rs. 3,23,278/- came to be transferred from the said account in the bank account of Vimal Agarwal. After enquiry, the informant came to know that there had been misappropriation of huge amount in the company. The informant, therefore, enquired about the financial transactions of the company through the Chartered Accountant of the company. After getting an Enquiry Report, the informant came to know that the applicant along with other accused had misappropriated total amount of Rs. 6,27,36,180/- by transferring the respective amounts in their accounts through the accounts of the companies. Accordingly, report came to be lodged in the Sahar Police Station.

5           The learned Advocate for the applicant/accused submitted that the applicant/accused has been falsely implicated and the informant is on vengeance spree against the co-accused and his childhood friend who he thinks are in league with the co-accused. It is contended that the amount which he had received from Sangeeta Aviation Services Pvt. Ltd. Company are towards consultation charges for the period from 2017 to 2021. All the accounts during the above said period, when the alleged fraud had taken place, have been audited by the company and the same have been signed by the applicant/accused and are submitted to the Competent Authority. The amounts, as alleged by the informant, which have been withdrawn by the applicant/accused are reflected in the company accounts and the accounts submitted in NCLT by the informant and also the account are over a period of more than four years which are in absolute knowledge of the informant and now he cannot ignore the same. It is further contended that the applicant/accused had no access to the accounts of the company, bank accounts of the company and also to the drawing of cheques and practically if all the cheques are verified by which the amount has been transferred by the company are mostly signed by the informant or the authorized person of the company who under no circumstances could be influenced by the applicant/accused. The bank accounts of the applicant/accused are attached by the police. It is further contended that this case is based on records and documents which are available with the NCLT, company of the informant and ROC and the same can be examined without the presence of the informant. As far as the present applicant/accused is concerned, entire allegation is over. The

custodial interrogation of the applicant/accused is not at all required. The applicant/accused had no criminal antecedents. He thus prayed that the applicant/accused was ready to abide by the terms and conditions imposed by the court, so the bail application be allowed.

6           The prosecution vide its say ( Exh. 05 ) resisted the application mainly on the ground that from the verification of the bank account it has been revealed that amount of Rs. 44,55,000/- and Rs. 97,400/- had been transferred to the account of the applicant/accused from the account of Sangeeta Aviation Service Pvt. Ltd. and the informant respectively. The said amount was misappropriated by him. The said amount is yet to be recovered from the applicant/accused. It is further submitted that it has been revealed that the money was transferred to the bank account of the accused even though the accused was not holding any position or providing any kind of service in both the companies. No resolution of the Board of Directors of the company has been approved regarding the said transferred amount. The said amount was misappropriated by the applicant and the co-accused. It is further submitted that the applicant/accused has produced intimation letter to Axis Bank and TDS Certificate ( 2017 to 2021 ). There is doubt regarding the authenticity of the said documents and investigation regarding the same is yet to be done. A case has been registered against the applicant/accused under Section 380, 384, 292, 506(2) of the Indian Penal Code read with Section 66 ( C ) of the Information Technology Act in Sahar Police Station and the applicant is on bail in that case. It is thus, prayed that the application be rejected.

7 Heard the learned counsel for the applicant, the learned APP for the State and the intervener.

8 Perused the application, the say filed thereon and the documents relied upon in support thereof.

9 It is contended by the applicant/accused that he was the childhood friend of the informant. The informant considered him to be in league with the co-accused, and so as he was in a vengeance spree against the co-accused, he had falsely implicated the applicant as well. It is also contended by him that the amount received by him was towards consultation charges he had extended to Sangeeta Aviation Service Pvt. Ltd. for the period 2017 to 2021. On the other hand, it is the case of the prosecution that the applicant was not the employee of the company and was not concerned with the company in any way. Admittedly, no document to show his appointment as a consultant is produced by the applicant. It is also further alleged that the amount which was transferred to the account of the applicant was then withdrawn in cash and that he had filed false TDS certificates. Further, as per the say of the Investigating Officer an amount of Rs. 45,52,400/- had been transferred into the account of the applicant from the account of Sangeeta Aviation Service Pvt. Ltd. from 15.11.2019 to 27.12.2021. It has come forth in the investigation that amongst the bank accounts of the informant and the companies i.e. Supreme Transport Pvt. Ltd. and Sangeeta Aviation Service Pvt. Ltd., the access ( authorized signatory ) of HDFC bank accounts was with accused Vimal and Girish, while the access ( authorized signatory ) of the rest of

the bank accounts was with Kamlesh Tatawat, the CFO of the company. From this, the investigation had revealed that the accused Vimal and Girish had embezzled a large amount of money in a pre-planned conspiracy with accused Kamlesh.

10 Further, during investigation the applicant was asked to produce the documents to show that he was working with or for the company Sangeeta Aviation Service Pvt. Ltd., but he did not produce any appointment letter or any such work order from the said company. In return during police custody, the applicant had produced the documents i.e. i) Intimation letter to Axis Bank ii) TDS Certificate of the year 2017-2018, iii) TDS Certificate of the year 2018-19 iv) TDS Certificate of the year 2019-2020 and v) TDS Certificate of the year 2020-2021 before Sahar Police. On perusal of the said documents, in the Intimation Letter, there are details of the amount given to the applicant/accused from the year 2017 to 2021, but it appears that the said amount is from previous transactions. Similarly, the TDS Certificate of the said amount had also been submitted by the accused. This means that the said amount had been accepted by the accused during that period, whereas the misappropriated amount in the crime is of the year 2021 and the amount shown in the Intimation Letter or TDS Certificate does not match. It is further submitted that the Investigating Officer when they tried to collect the said amount from the applicant, he said that the said amount was again spent by the applicant/accused in the project work of the company. The question rightly put forth by the investigating agency why the applicant/accused is lying in investigation in the police custody as to why he would spend the money in

the project and give it back to the company.

11 It is seen that the offence is purely economic in nature. Serious allegations of misappropriation of Rs. 45,52,400/- is made against the applicant himself. The investigation is still in progress. From the documents filed on record prima-facie it is seen that the applicant was involved in the commission of the crime. There are prima-facie ingredients of fabrication of documents. This entire case is based on documentary evidence. The possibility of tampering with the evidence cannot be ruled out, if the applicant is released on bail. Hence, the following order is passed :

**ORDER**

Criminal Bail Application No. 570 of 2023 is hereby rejected and disposed of accordingly.

sd/-

(DR. (SMT.) SRISHTY NEELKANTH )  
Additional Sessions Judge,  
City Civil Court, Borivali Division,  
Dindoshi, Goregaon, Mumbai.

Date : 19/07/2023

Dictated on Computer : 19/07/2023  
Checked & Corrected on : 21/07/2023  
Sign on : 21/07/2023

CERTIFIED TO BE TRUE AND CORRECT COPY OF THE ORIGINAL SIGNED JUDGMENT/ORDER."

24/07/2023 at 11.10 a.m.  
UPLOAD DATE AND TIME

Mrs. S.B. Vichare  
NAME OF STENOGRAPHER

Name of Judge (with Court room no.)	HHJ Dr. (Smt) Srishty Neelkanth City Civil & Sessions Court, Borivali Div., Dindoshi, Mumbai ( C.R.No. 04 )
Date of Pronouncement of JUDGEMENT/ORDER	19/07/2023
JUDGEMENT/ORDER signed by P.O. on	21/07/2023
JUDGEMENT/ORDER uploaded on	24/07/2023



सत्यमेव जयते  
महाराष्ट्र शासन  
पोलीस विभाग



दुरध्वनी क्रमांक ०२२- २६८३१५८२, २६८३१४४७  
ईमेल आयडी ps.andheri.mum@mahapolice.gov.in

वरिष्ठ पोलीस निरीक्षक अंधेरी पोलीस ठाणे  
अंधेरी रेल्वे स्टेशन समोर, सहार रोड, अंधेरी पुर्व

संदर्भ जा.क्र. १४०१४/वपोनि/अंधेरी पो.ठाणे/२०२२.

मुंबई ४०००६९ दिनांक :- २७/१२/२०२२

प्रति,

वरिष्ठ पोलीस निरीक्षक,  
सहार पोलीस ठाणे, मुंबई

विषय :- सुप्रीम ट्रान्सपोर्ट ओ आर जी प्रा. लि यांच्या तक्रार अर्जबाबत.

संदर्भ :- मार्गस्थ नोंद वही क्र 109.B.2022 दिनांक २७/१२/२०२२

उपरोक्त विषय व संदर्भान्वये सदरचा तक्रार अर्ज दिनांक २७/१२/२०२२ रोजी मा. पोलीस उप आयुक्त, परिमंडळ - १० मुंबई यांच्या कार्यालयामार्फतीने अंधेरी पोलीस ठाणेस प्राप्त झाला आहे. सदर तक्रार अर्जाचे अवलोकन केले असता सदरची घटना ही सहार पोलीस ठाण्याच्या हद्दीतील असल्याचे निष्पन्न झाले आहे.

सबब सदरचा अर्ज आपल्या पोलीस ठाण्यास निगडित असल्याने तो पुढील चौकशी व परस्पर निपटारा करणेकामी आपले पोलीस ठाण्यास पाठवत आहे.

A PS - Shinde R H/A

वरिष्ठ पोलीस निरीक्षक,  
सहार पोलीस ठाणे, मुंबई  
दिनांक ३१/१२/२०२२  
आ.क्र. ३६४३/वरिष्ठ/अर्जांक/२०२२  
TR/३६४३/२०२२

(संताजी घोरपडे)

वरिष्ठ पोलीस निरीक्षक,  
अंधेरी पोलीस ठाणे, मुंबई.

प्रत माहितीकरीता

- १) मा. पोलीस सह आयुक्त, आर्थिक गुन्हे शाखा,, पोलीस आयुक्तांचे कार्यालय, मुंबई
- २) मा. पोलीस उप आयुक्त, परिमंडळ - १० मुंबई

TR/३६४३/२०२३



सदरक्षणाय खलनिग्रहणाय



महाराष्ट्र शासन



स्वातंत्र्याचा अमृत महोत्सव

Telephone No.- 22672770  
Email ID- jtcp.eow@mahapolice.gov.in

Office of the Joint Commissioner of Police,  
Economic Offences Wing, Third floor, New building,  
Commissioner of Police compound, Dr. D N Marg,  
Opp. Mahatma Phule Market, Mumbai – 400 001.

OW. No. 1600 /JtCP/EOW/2022

Date - 19 /12/2022

To,  
The Dy. Commissioner of Police,  
Zone -X, Mumbai.

**Sub:** Complaint / Petition / Email, dated 06/12/2022 received from Captain Ammeet K Agarwal, President & CEO, Supreme Transport Org Pvt. Ltd., Andheri (E) against Mr. Vimal Agrawal and others for fraud.

**Ref:** I. W. No. 10060 / EOW / 2022, Date: 10/12/2022

Please find enclosed herewith all original papers including complaint received from the applicant referred above. On scrutiny of the above complaint/petition, it is noticed that the matter mentioned therein pertains to the jurisdiction of your office/department, and as per directions of Jt. Commissioner of Police, Economic Offences Wing, Mumbai the same is forwarded for necessary action at your end and direct disposal under intimation to the applicant.

**Please be informed that:** -

1. This office has not carried out any enquiry in this matter and none of the original papers are kept at this office.
2. In respect of the above complaint, if any action is required to be taken by this office, you are requested to communicate accordingly to this office under intimation to the present applicant / petitioner.

(KishorParab)

Sr. Inspector of Police,  
Add. Charge Asst. Commr. of Police (Admn.),  
For Jt. Commissioner of Police,  
Economic Offences Wing, Mumbai.

**Encl:** Complaint application mentioned ref. as above.

**Copy to:** -

Captain Ammeet K Agarwal, President & CEO, Supreme Transport Org Pvt. Ltd., Add- 5B 345 Mittal Ind. Estate, M V Road, Andheri (E), Mumbai – 4000 59.

You are requested to contact to office of the Dy. Commissioner of Police, Zone-X, Mumbai, O/at, MIDC Police Station Building, 2<sup>nd</sup> Floor, Central Main Road, MIDC, Andheri East), Mumbai - 400 069 in respect of this matter.

(KishorParab)

Sr. Inspector of Police,  
Add. Charge Asst. Commr. of Police (Admn.),  
For Jt. Commissioner of Police,  
Economic Offences Wing, Mumbai.



सदरक्षणाय खलनिग्रहणाय



महाराष्ट्र शासन



स्वातंत्र्याचा अमृत महोत्सव

Telephone No.- 22672770  
Email ID- jtcp.eow@mahapolice.gov.in

Office of the Joint Commissioner of Police,  
Economic Offences Wing, Third floor, New building,  
Commissioner of Police compound, Dr. D N Marg,  
Opp. Mahatma Phule Market, Mumbai – 400 001.

OW. No. 1600 /JtCP/EOW/2022

Date - 19 /12/2022

To,  
The Dy. Commissioner of Police,  
Zone -X, Mumbai.

**Sub: Complaint** / Petition / Email, dated 06/12/2022 received from Captain Ammeet K Agarwal, President & CEO, Supreme Transport Org Pvt. Ltd., Andheri (E) against Mr. Vimal Agrawal and others for fraud.

**Ref: I. W. No. 10060 / EOW / 2022, Date: 10/12/2022**

Please find enclosed herewith all original papers including complaint received from the applicant referred above. On scrutiny of the above complaint/petition, it is noticed that the matter mentioned therein pertains to the jurisdiction of your office/department, and as per directions of Jt. Commissioner of Police, Economic Offences Wing, Mumbai the same is forwarded for necessary action at your end and direct disposal under intimation to the applicant.

**Please be informed that:** -

1. This office has not carried out any enquiry in this matter and none of the original papers are kept at this office.
2. In respect of the above complaint, if any action is required to be taken by this office, you are requested to communicate accordingly to this office under intimation to the present applicant / petitioner.

(KishorParab)

Sr. Inspector of Police,  
Add. Charge Asst. Commr. of Police (Admn.),  
For Jt. Commissioner of Police,  
Economic Offences Wing, Mumbai.

**Encl:** Complaint application mentioned ref. as above.

**Copy to:** -

Captain Ammeet K Agarwal, President & CEO, Supreme Transport Org Pvt. Ltd., Add- 5B 345 Mittal Ind. Estate, M V Road, Andheri (E), Mumbai – 4000 59.

You are requested to contact to office of the Dy. Commissioner of Police, Zone-X, Mumbai, O/at, MIDC Police Station Building, 2<sup>nd</sup> Floor, Central Main Road, MIDC, Andheri East), Mumbai - 400 069 in respect of this matter.

(KishorParab)

Sr. Inspector of Police,  
Add. Charge Asst. Commr. of Police (Admn.),  
For Jt. Commissioner of Police,  
Economic Offences Wing, Mumbai.

TR 109/14/22

प. नि. मा. नं.

पो. नि. / स. नि. / पो. उप. नि. / स. फौ.  
यांनी लोकांसाठी वरदान / योग्य प्रतिबंधक  
कारवाही करून घ्यावी असा आदेश दिवसात  
सादर करावा.

24/12  
व. नि. पो. नि. निरीक्षक,  
अंधेरी पो. ठाणे, मुंबई

F-586/DCP/14/22

वपोनि. . . अंधेरी	पोलीस ठाणे
यांनी लोकांसाठी वरदान / योग्य प्रतिबंधक	कारवाही करून घ्यावी असा आदेश दिवसात
कारवाही करून घ्यावी असा आदेश दिवसात	सादर करावा.
आ. क्र. . . 1554	व. नि. पो. नि. निरीक्षक, अंधेरी पो. ठाणे, मुंबई.
दि. 23/12/22	पो. नि. मा. नं. / पो. उप. नि. / स. फौ.



# SUPREME TRANSPORT ORG PVT LTD

12334  
09/12



5B 34 Mittal Ind Estate MV Road Andheri East Mumbai 400059 INDIA +91 9870811224  
8601 Park Lane #313 Dallas TEXAS USA +1 703 810 9054  
www.supremeaviation.com ammeet@supremeaviation.com www.stopl.in  
\*\*\*\*\*

December 6<sup>th</sup> 2022

To,

**Joint Commissioner of Police**  
Economic Offence Wing, Mumbai Police  
Mumbai Police HQ, Mumbai

आ.क्र./10060/जागुवि/2022  
10/12

Dep zone X  
Pawar  
पोलीस सह आयुक्त  
आर्थिक गुन्हे विभाग, मुंबई

**Re: Requesting inquiry, investigation followed by appropriate action as per law, in a matter of fraud of Rs. 23+ Crores by:**

- 1. MR. VIMAL AGRAWAL & NUPUR AGRAWAL** +91 93421 37351  
Resident of B306, Sai Krupa Elite, Doddenkundi, Fern City Rd, Marathahalli,  
Bengaluru 560037
- 2. MR. GIRISH AGRAWAL & SAMIXA AGRAWAL** +91 9311701121  
Resident of A40 Kewal Kunj Apt, Sector 13, Rohini, New Delhi 110085
- 3. Ms. PINKY AGRAWAL** +91 98230 84559  
Resident of BHAYANDER
- 4. MR. SWAPNIL CHAVAN & MS. SNEHA** +91 85910 77096  
Resident of Chavan Chawl, Marol Maroshi Road, Andheri East, Mumbai 59
- 5. MR. ATUL PANDEY & MS. RAJINI PANDEY** +91 98672 42345  
Resident of Yogendra Bhawan, JB Nagar, Andheri East, Mumbai 59
- 6. Mr. Kamlesh Bairwa Tatawat** +91 80786 55144  
**7. Mr. Mukesh Bairwa Tatawat** +91 96808 10176  
Resident of 89D, Narayan Vihar – 1<sup>st</sup>, Jagannathpura, Sanganer, Jaipur 302029
- 8. Mr. Ramesh Kakria** +91 98700 85405  
Resident of Gokuldharm, Goregaon East, Mumbai 400097

\*\*\*\*\*

Respected Sir,

We seek your indulgent consideration, on the subject afore mentioned, on behalf of M/S Supreme Transport Organisation Pvt Ltd:

- Please find attached ANNEX – 1, a letter from AUDITOR C.A. Girish Mundada, confirming fraud of more than Rs. 5 Crores conducted by accused number 1 to 3 afore mentioned.

\*\*\*\*\*

Continued..



*From Where.. Dreams take off...*

ISO 9001: 2008

N# U60230MH2008PTC216143 US Corp# 801109175 SUPREME TRANSPORT ORG PVT LTD enterprise



# SUPREME TRANSPORT.ORG PVT LTD



5B 34 Mittal Ind Estate MV Road Andheri East Mumbai 400059 INDIA  
8601 Park Lane #313 Dallas TEXAS  
www.supremeaviation.com ammeet@supremeaviation.com  
\*\*\*\*\*

+91 9870811224  
USA +1 703 810 9054  
www.stopl.in

Continued..

2. Please find attached ANNEX – 2, a letter copied to us as party 4, which was copied to your office as well, which clearly indicates fraud of more than Rs. 1.70 Crores conducted by accused 4 to 7 afore mentioned.
3. Please find attached ANNEX – 3, a letter dated 24<sup>th</sup> June 2022, which was copied to your office as well, which clearly talks about cash and fraud of more than Rs. 10 Crores.
4. Property documents worth more than Rs. 2.5 Crores have been taken in illegitimate possession of accused #1 afore mentioned (annexure – 4 copies of such documents)
5. Property documents worth more than Rs. 3 Crores have been taken in illegitimate possession of accused #2 afore mentioned (annexure – 5 copies of such documents)  
\*\*\*\*\*
6. I, Captain Ammeet K Agarwal, aged 34 years, resident of 901 Bikaner Bhawan, JB Nagar, Andheri East, Mumbai 400059, living with my father Shri Kamal Agarwal and mother Mrs. Sangita Agarwal since 2015; and in Mumbai since birth in 1988; I am President, Director and CEO of M/S Supreme Transport Org Pvt Ltd (STOPL) and M/S Sangeeta Aviation Services Pvt Ltd (SASPL), with head offices at 5B 34 and 5b 32, Akshay Mittal Industrial Estate, MV Road, Andheri East, Mumbai 400059 for more than 10 years; am a Commercial Pilot by qualification, holding licenses from USA.
7. In the month of September 2022, we came to know through Bank of India branch in Bengaluru, that from STOPL's account, accused #1 Mr. Vimal Agrawal had transferred funds to his personal account. (Copy attached as annex 6 for your reference).
8. We immediately informed our auditor to further conduct investigation on such transfers and submit detailed report. His report was recently received (copy attached as annex 7 for your reference). This report was shocking since Mr. Vimal Agrawal along with his wife Nupur Agrawal, his brother Girish Agrawal, his wife Samixa Agrawal and their sister Pinky Agrawal, in the last few months, have siphoned off more than Rs. 5 Crores from our company's accounts and funds.

Continued..



*From Where.. Dreams take off...*

ISO 9001: 2008



# SUPREME TRANSPORT ORG PVT LTD



5B 34 Mittal Ind Estate MV Road Andheri East Mumbai 400059 INDIA +91 9870811224  
8601 Park Lane #313 Dallas TEXAS USA +1 703 810 9054  
www.supremeaviation.com ammeet@supremeaviation.com www.stopl.in  
\*\*\*\*\*

Continued..

9. Our mediators tried to speak to them for amicable settlement of these funds. However, they simply replied to the mediators that these amounts are their salaries for last 4 years! How can Nupur, Samixa, Pinky – all 3 ladies draw salaries from the company?
10. Further, our mediators and auditor asked them, if they have any proof of authorization to draw salaries or pay themselves fraudulently in the name of salaries? **This is violation of the company's act.** To which obviously, they have no reply. Matter of fact, annexure 8 are prayers from accused #1 and #2's own petition filed before NCLT, where they have clearly prayed for Director's remuneration since April 2019. Hence they stating that they have drawn these funds as their remuneration or salaries, are contradictory to their own submissions in NCLT on oath.
11. Further, our mediators and auditors clearly asked if they have done any business or work, generated any sales or revenues for the company, at least in last 4 years? To which, it is obvious that they have not worked at all, hence fraud of more than Rs. 5 Crores is evident and clearly visible.
12. To avoid any further pressure from us, our mediators and others, both Vimal and Girish have filed a frivolous application/petition in NCLT on 11<sup>th</sup> November 2022. Such petition is now being used by them to blackmail us, to not inquire in their Rs. 5+ Crore fraud.
13. Further, Mr. Vimal tried to sell company's property/plot located at **Municipal New No.51/1, Situated at 9th A Main Road, Banaswadi, Bangalore**, for Rs. 2.50 Crores. His intention was to take the payment in the same Bank of India account of the company, which is in his control, and further siphon off Rs. 2.50 Crores of company's money to his personal account. He is still holding possession of original documents of company's property, which needs to be in company's headquarters, despite of our several instructions to him to deposit the company's property papers.

Continued..



SUPREME  
AIRLINES

*From Where.. Dreams take off...*

ISO 9001: 2008



# SUPREME TRANSPORT ORG PVT LTD



5B 34 Mittal Ind Estate MV Road Andheri East Mumbai 400059 INDIA +91 9870811224  
8601 Park Lane #313 Dallas TEXAS USA +1 703 810 9054  
www.supremeaviation.com ammeet@supremeaviation.com www.stopl.in  
\*\*\*\*\*

Continued..

14. Further, Mr. Girish tried to sell company's property/plot located at **D 338 Aara Machine Wali Gali, Man Pawana Road, Opp Shabad Dairy, Bharti Vihar, Bawana Road, Doulatpur, Delhi 110 042**, for Rs. 3 Crores. His intention was to take the payment in the same Bank of India account of the company, which is in his and his brother Vimal's control, and further siphon off Rs. 3 Crores of company's money to his personal account. He is still holding possession of original documents of company's property, which needs to be in company's headquarters, despite of our several instructions to him to deposit the company's property papers.

15. Further, Mr. Girish Agrawal has collected Rs. 1.20 Lakhs cash **EVERY MONTH of RENT from this property, from his local renter, illegitimately against company's interest. This has been happening for at least last 4+ years, which itself amounts to more than Rs. 60 Lakhs in rental fraud of company's property.**

16. We request your offices to please arrest the accused; recover original property papers from them; their residences should be attached so that the company can recover such Rs. 5+ crores siphoned off by them from the company's funds.

\*\*\*\*\*

17. Accused #4 and #5 - Swapnil Chavan and Atul Pandey are believed to own and operate a shell company – M/S Million Air Pvt Ltd. This company is a fraudulent company, since it is not in compliance with the Income Tax, G.S.T., Ministry of Corporate Affairs and R.O.C. requirements as visible on websites. (Annex 9 Attached)

18. Both Swapnil Chavan and Atul Pandey have made M/S Sangeeta Aviation Services Pvt Ltd (SASPL), transfer more than Rs. 1.70 Crores to their personal accounts, their mother's account viz Mrs. Sneha Chavan and Mrs. Rajini Pandey; also in an account in DUBAI owned by Mr. Swapnil Chavan. (Annex 10 Attached)



19. Such monies are purely transferred against extortion and blackmailing, for submitting fake bids in state government tenders by their company Million Air Pvt Ltd (Annex 11 attached)

Continued..



SUPREME  
AIRLINES

*From Where.. Dreams take off...*

ISO 9001: 2008



# SUPREME TRANSPORT ORG PVT LTD



5B 34 Mittal Ind Estate MV Road Andheri East Mumbai 400059 INDIA +91 9870811224  
8601 Park Lane #313 Dallas TEXAS USA +1 703 810 9054  
www.supremeaviation.com ammeet@supremeaviation.com www.stopl.in  
\*\*\*\*\*

Continued..

20. Mr. Swapnil Chavan was arrested by SAHAR Police on 22<sup>nd</sup> February 2022, for similar extortion and black mailing FIR registered by me. It is evident that both the accused have no jobs, no business, no source of income and hence since last few years, apart from black mailing and extortion, they cannot accept any other means of livelihood and survival. Your further investigation on them would reveal their background, income and source of livelihood.
21. On further investigating through reliable sources, it was found that this entire money of Rs. 1.70 Crores, transferred to aforementioned 4 account holders in Mumbai and 1 in Dubai, was **CASH WITHDRAWN COMPLETELY 100% by the accused.**
22. This further attracts the income tax, GST, PMLA and various government violations including HAWALA done from Dubai. They have set a precedent that anyone can operate a SHELL COMPANY, submit fake bids and BLACKMAIL genuine bidders to collect extortion monies of more than Rs. 1.70 Crores.
23. Swapnil Chavan has been sending WHATSAPP messages to more than 30 high networth individuals, politicians, Bollywood and close contacts of myself, in last 4 months, using this number **+44 7983 855 602** (Annex 12 attached).
24. These messages have 90% generic content consisting of 20-25 forwards including FIR, news articles and other defamatory material AGAINST myself.
25. The balance 10% content is specifically targeted to stir poison between the recipient and myself. People who can confirm receipt of such messages:

- |       |                         |  |                 |
|-------|-------------------------|--|-----------------|
| i.    | Mr. Nishant Pittie      | Owner of STOCK LISTED COMPANY          | +91 98110 49345 |
| ii.   | Mr. Sanjay Shah         | Close contact of BJP lobby             | +91 93249 68581 |
| iii.  | Mr. Dhruv Agrawal       | OSD to a cabinet minister              | +91 99603 83838 |
| iv.   | Mr. Sameer Upadhyay     | Political Advisor to Paresh Rawal      | +91 99100 72605 |
| v.    | Mr. Chandraprakash Todi | High Networth Businessman              | +91 97648 35813 |
| vi.   | Dr. Sudhir Desai        | Renowned Doctor in AMERICA             | +1 269 275 2792 |
| vii.  | Mr. Trivikram Joshi     | Ex-MLA BJP Karnataka                   | +91 94481 10099 |
| viii. | Mr. Neeraj Morarka      | High Networth Businessman              | +91 99201 33373 |
| ix.   | Capt Ajay Chauhan       | Dir of Civil Aviation, Govt of Gujarat | +91 99099 18888 |
| x.    | Mr. Dominic Savio       | Chhattisgarh Civil Aviation Dept       | +91 94255 20679 |



*From Where.. Dreams take off...*

ISO 9001: 2008



# SUPREME TRANSPORT ORG PVT LTD



5B 34 Mittal Ind Estate MV Road Andheri East Mumbai 400059 INDIA +91 9870811224  
8601 Park Lane #313 Dallas TEXAS USA +1 703 810 9054  
www.supremeaviation.com ammeet@supremeaviation.com www.stopl.in  
\*\*\*\*\*

- |       |                    |   |                  |
|-------|--------------------|---|------------------|
| xi.   | Mr. Ajay Sandey    | Chhattisgarh Civil Aviation Dept          | +91 881 7676 066 |
| xii.  | Shama Sikandar     | Bollywood Actress                         | +91 99303 06770  |
| xiii. | Bina Gaikwad       | Blackmailed by showing videos             | +91 99300 12399  |
| xiv.  | Shikha Agarwal     | <b>BLACKMAILED for 10 Lakhs by videos</b> | +91 84692 22333  |
| xv.   | Chandni Kanoria    | BLACKMAILED by showing VIDEOS             | +91 98203 43304  |
| xvi.  | Rinku Dudani       | BLACKMAILED by showing VIDEOS             | +91 98194 20890  |
| xvii. | Capt Akash Agarwal | Resident of AMERICA                       | +1 703 810 9054  |

26. Swapnil Chavan has been doing such nuisance, so that I don't take any further action against him, including exposing this scam of Rs. 1.70 Crores as afore mentioned.

27. Further, we have 2 video clips where Swapnil Chavan is clearly visible consuming drugs. It is strongly believed that all this money was used for illicit drug trading by him for his survival and income.

28. We request your office to conduct fair investigation followed by arrest of the accused at the earliest. Further, please help recover Rs. 1.70 Crores transferred to them for blackmailing and extortion.

\*\*\*\*\*

29. All the monies which were transferred to accused #4 and #5, were transferred by accused #6 and #7 – Kamlesh Bairwa and Mukesh Bairwa. Both the accused joined my office in November 2016 (Annex 13 attached). After handling complete accounting and operations of my companies for more than 6 years, they both disappeared in the last week of August 2022.

30. Mediators and auditors have spoken to both on several occasions, including asking them to return to office to continue the works. They both have refused, since they both fear exposure of the entire scam, after the complaint filed as per ANNEX -2.

31. Further, they both have all the usernames, passwords, access to all accounts, data and finances of our companies, EXCLUSIVELY. They both are believed to be hands in gloves with accused #1 to #5, since complete transactions are conducted by them or with their help.

\*\*\*\*\*

32. I was in USA from 16<sup>th</sup> May 2022 to 10<sup>th</sup> November 2022. I have lived in USA off and on from 2006. During my travel for 6 months, Mr. Varun Kakria, my executive secretary for last 8+ years, have disappeared from my office in August last week.



*From Where.. Dreams take off...*

ISO 9001: 2008



# SUPREME TRANSPORT ORG PVT LTD



5334 Mittal Ind Estate MV Road Andheri East Mumbai 400059 INDIA +91 9870811224  
8601 Park Lane #313 Dallas TEXAS USA +1 703 810 9054  
www.supremeaviation.com ammeet@supremeaviation.com www.stopl.in  
\*\*\*\*\*

33. All my business, my works, my lobbying, my legal matters and each and every activity of both the companies and my family, were looked by Mr. Varun Kakria exclusively.

34. He started in 2014 at Rs. 18,000 per month / Rs. 2 lakhs per year package. In last 2 years he was drawing more than Rs. 1.65 Lakhs per month / Rs. 20 Lakhs package per year.

35. I believe, that Mr. Varun Kakria was aware of afore mentioned funds transfers, scams, siphoning conducted by accused #1 to #7, hence to escape, he disappeared in last week of August 2022. Especially after the letter which was received in June marked as Anx-3, he realized that sooner or later the scam would be exposed.

36. Prima facia, funds of more than Rs. 5 Crores have been transferred from the bank accounts to accused to #1 to #3. Funds of more than Rs. 1.70 Crores have been transferred to accused #4 and #5. All funds transfers have exclusively been done by accused #6 and #7. Considerable cash withdrawals in excess of Rs. 10 Crores are visible as well, and hence letter annexure 3 becomes sensible. Company's original property documents of Rs. 2.50 Crores are in illegitimate possession of Mr. Vimal Agrawal; Company's original property documents of Rs. 3 Crores are in illegitimate possession of Mr. Girish Agrawal. Hence crime and fraud has already been conducted by all the accused, with evidence, hereby submitted for your perusal.

37. We request your office to fairly investigate this fraud and take appropriate actions as per law including immediate arrest of all the accused.

38. I shall be available for statements and all further queries the department may have in this case. Thank you. Sincerely,

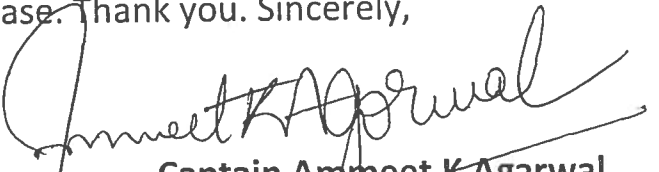
  
Captain Ammeet K Agarwal  
President & CEO

\*\*\*\*\*



*From Where.. Dreams take off...*

ISO 9001: 2008

CIN# U60230MH2008PTC216143 US Corp# 801109175 SUPREME TRANSPORT ORG PVT LTD enterprise



# LOYA & MUNDADA

## Chartered Accountants

21/11/2022

To,

Captain Ammeet K Agarwal  
President & CEO, Director  
M/S Supreme Transport Organisation Pvt Ltd  
5B 32 Akshay Mittal Industrial Estate, MV Road,  
Andheri East, Mumbai 400059

**RE: Auditing fraud conducted by Vimal Agrawal and others**

Dear Sir,

Reference is made to your letter received on 6<sup>th</sup> September 2022, our initial reply on 7<sup>th</sup> September 2022.

On conducting thorough audit of the financials, bank statements, accounts and all other data available, we shockingly share with you, Chairman and the board that:

A total amount in excess of Rs. 5 CRORES has been siphoned off in similar fashion, by Mr. Vimal Agrawal, Mrs. Nupur Vimal Agrawal, Mr. Girish Agrawal, Mrs. Samixa Girish Agrawal and Ms. Pinky Agrawal to their accounts, from the accounts of the company.

The board may proceed with appropriate action, as required by the law, since this violates company's act as well, along with theft, siphoning off monies and other crimes.

Thanking you.

FOR LOYA AND MUNDADA  
Chartered Accountants  
Firm Registration Number 132811W

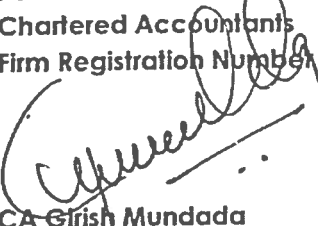
  
CA Girish Mundada  
Partner  
Membership Number 141172



**AURANGABAD OFFICE :** 315, 3rd Floor, Sai Trade Center, Near Railway Station, RTO Road, Aurangabad- 431001  
**Contact :** +91-9422925422 | **Email :** mundadagirish@gmail.com

**PUNE OFFICE :** Flat No 12, 4th Floor, Butte Patil Tower, Ganjve Chowk, LBS Road, Sadashiv Peth, Pune- 411030  
**Contact :** +91-9422201966 | **Email :** lokeshgodha.1@gmail.com



# LOYA & MUNDADA

Chartered Accountants

07/09/2022

To,

Captain Ammeet K Agarwal  
President & CEO, Director  
M/S Supreme Transport Organisation Pvt Ltd  
5B 32 Akshay Mittal Industrial Estate, MV Road,  
Andheri East, Mumbai 400059

**RE: Auditing fraud conducted by Vimal Agrawal and others**

Dear Sir,

Reference is made to your letter received yesterday. Due to deadline of all audited financials being 30<sup>th</sup> September 2022, our firm is heavily occupied with other committed works.

However, we are shocked to learn the recent fraud conducted by Vimal Agrawal. Trust us, we shall independently and fairly investigate all the accounts, conduct thorough audit and share with you and the board, the results of the same at the earliest.

Thanking you.

For Loya & Mundada  
Chartered Accountants  
Firm Registration No. 1228117

CA Ghanshi G. Mundada  
Partner  
Membership No. 141172

AURANGABAD OFFICE : 315, 3rd Floor, Sai Trade Center, Near Railway Station, RTO Road, Aurangabad - 431001  
Contact : +91-9422925422 | Email : mundadagirish@gmail.com

PUNE OFFICE : Flat No 12, 4th Floor, Butte Patil Tower, Ganjve Chowk, LBS Road, Sadashiv Peth, Pune - 411030  
Contact : +91-9422201966 | Email : lokeshgodha.1@gmail.com



# SUPREME TRANSPORT ORGANISATION PVT LTD

AN ISO 9001: 2008 COMPANY CIN NO U60230MH2008PTC216143 MSME REGD NO 27222200461

Regd Off 5 B 34 Akshay Mittal Industrial Estate M V Road Andheri East Mumbai 400 059  
Tel +91 22 4238 3904 05 06 07 Fax +91 22 42383945  
Email mumbai@stoptl.in Website www.stoptl.in

September 6<sup>th</sup> 2022

To,

Mr. Girish Mundada, C.A.  
Loya & Mundada Chartered Accountants  
315, 3<sup>rd</sup> Floor, Sai Trade Center,  
Near Railway Station, RTO Road  
Aurangabad 431001

**RE: Auditing fraud conducted by Vimal Agrawal and others**

Dear Girish Ji,

We seek your indulgent consideration, on the subject  
afore mentioned, on behalf of M/S Supreme Transport Organisation Pvt Ltd:

1. Please find attached email received from Bank of India dated 5<sup>th</sup> September 2022 for your perusal.
2. We request you to please conduct a thorough audit and investigate what amounts have been siphoned off, in similar way, by Mr. Vimal Agrawal.
3. Please keep the Chairman and the Board apprised about your audit outcome, so we can proceed with appropriate legal action. Thank you.

Sincerely,

Captain Ammeet K Agarwal  
President & CEO  
Director



To,

Time: ~~17/10/2022~~ Date: 16.13.22  
Dispatch Writer,  
Economic Offences Wing,  
Shri Satyabrata Kumar I.P.Sing,  
Mumbai  
Joint Director - Enforcement Directorate  
4th Floor, Kaiser-I-Hind Building,  
Currimbhoy Road, Ballard Estate, Mumbai 400001

October 14<sup>th</sup> 2022  
प्रवर्तन निदेशिका  
आंचलिक कार्यालय, मुंबई  
दिनांक: 17 OCT. 2022  
प्राप्त

Shri Pravinkumar Padwal I.P.S.

Joint C.P. – Economic Offences Wing, Mumbai Police  
3rd Floor, 25, Lokmanya Tilak Marg, Police Colony,  
Dhobi Talao, Lohar Chawl, Kalbadevi, Mumbai 400002

Shri Datta Nalawade I.P.S.

DCP – Anti Narcotics, Mumbai Police  
3<sup>rd</sup> Floor Narcotics Control Bureau, Exchange Bld, Sprott Road  
Ballard Estate, Mumbai 400001

Received  
H  
17/10/2022  
Anti Narcotics Cell,  
C.B., C.I.O., Mumbai.

CC: Captain Ammeet K Agarwal  
President & CEO - Supreme Transport Organisation Pvt Ltd  
5B 34 Akshay Mittal Industrial Estate, MV Road,  
Andheri East, Mumbai 400059

Re: Whistle blowing for PMLA Act 2002 and other IPC, for money laundering, extortion, fake bidding, Narcotics by MR. SWAPNIL CHAVAN & MR. ATUL PANDEY through fake firm M/S Million Air Pvt Ltd in govt tenders, involving DUBAI, UAE transactions; CRORES of Rs. of CASH withdrawal through personal accounts  
USE OF CASH of RS. 1.40 CRORES for DRUGS TRADING

Respected Sirs',

1. Annexure 1 is a copy of license to do business in UAE of a fake company, which existed and is no more in existence, owned by Mr. Swapnil Chavan, resident of Marol Maroshi Road, Andheri East, Mumbai - +91.8591077096
2. Annexure 2 is a copy of bank statement from Noor Bank in UAE, involving money laundering transactions conducted by Mr. Swapnil Chavan.
3. Annexure 3 is his onetime Visa/permit to enter Dubai, UAE.
4. Annexure 4 is a screenshot from GST of Union of India portal, where his company M/S Million Air Pvt Ltd's non-compliance is clearly visible.
5. Annexure 5 is a summary of transactions and bank accounts, belonging to Mr. Swapnil Chavan and his mother Ms. Sneha Chavan of almost Rs. 1 Crore. Please note - the entire amount has been WITHDRAWN CASH.

Continued..

Continued..

6. Annexure 6 is a complete set of BIDDING DOCUMENTS submitted to State Govt of Chhattisgarh, with fake certificates, shell company with no transactions and 0 income, with failure to comply with ROC, MCA, GST, IT and other departments of Union of India, as of today, visible on all portals.
7. Annexure 7 is a complete set of BIDDING DOCUMENTS submitted to State Govt of Gujarat, with fake certificates and same as annexure 6.
8. Annexure 8 is a complete set of BIDDING DOCUMENTS submitted to State Govt of Rajasthan, with fake certificates and same as annexure 6 and 7.
9. I am an EX-EMPLOYEE of M/S Sangeeta Aviation Services Pvt Ltd, which secured L1 and winning bidder, in all 3 afore mentioned tenders. Same can be verified easily.
10. Mr. Swapnil Chavan and Mr. Atul Pandey (+91 9867242345) had submitted FAKE BIDS in all these tenders through their ONE FAKE COMPANY M/S Million Air Pvt Ltd, to support M/S Sangeeta Aviation Services Pvt Ltd. Same can be verified easily.
11. In exchange of such fake bids, both Mr. Swapnil Chavan and Mr. Atul Pandey, demanded/extorted a total amount of Rs. 1.23 Crores plus Rs. 47 lakhs respectively, = Rs. 1.70 Crores, transferred to both their personal accounts and in Dubai, through M/S Sangeeta Aviation Services Pvt Ltd. Same can be verified easily.
12. Annexure 9 are bank statements from ICICI of Mr. Swapnil Chavan showing certain transactions. Other bank statements can be easily obtained verifying transactions.
13. Since M/S Sangeeta Aviation Services Pvt Ltd became insolvent through NCLT on 10<sup>th</sup> August 2021, there was no inquiry made on this company by any department.
14. The reason I am exposing this scam now, is because I was beaten up badly few days ago, on instruction of Swapnil Chavan and Atul Pandey. I worked for Rs. 11,000 and come from a very poor family. I don't have means to register FIR against Swapnil and Atul for beating me up and breaking my bones.
15. After beating me up badly, the other 3 employees eloped to their villages as well, because they think they will be beaten up too. All this scam took place in front of our eyes and we are witness to the entire scam.
16. The entire amount of Rs. 1.40 Crores was CASH WITHDRAWN by both ATUL PANDEY and SWAPNIL CHAVAN; Rs. 30 Lakhs HAWALA in Dubai; and entire amount was used to TRADE DRUGS by both of them. Same can be verified easily.

Continued..

Continued..

17. Mr. Manish Jain (+91 9022938833) was the drug supplier who ensured supply EVERY NIGHT after 11 PM to both Swapnil and Atul Pandey. Same can be verified easily.
18. I have copied M/S Supreme Transport Organisation Pvt Ltd on purpose, for many reasons. One of the reason is that their bids were always disqualified, though they were the most eligible company and experienced for these works.
19. It is because of this scam arrangement between M/S Sangeeta Aviation Services Pvt Ltd and M/S Million Air Pvt Ltd, qualified bidder like Supreme Transport had to suffer.
20. Further, Annexure 10 is a copy of the FIR against Mr. Swapnil Chavan, in another blackmailing and extortion case, reported by person copied from Supreme Transport. As you may understand, these criminals have a history of blackmailing, extortion and other crimes.
21. These documents are not being submitted to set my scores even with Swapnil Chavan and Atul Pandey for beating me up and breaking my bones, but to bring to your knowledge, that open CRIME has been committed, in broad day light in Mumbai City, right in front of your police stations including Sahar Police.
22. If you don't arrest and put both Swapnil Chavan and Atul Pandey, upto certain extend Manish Jain behind bars, it would encourage and you would set precedent:
  - Register fake companies with ROC, MCA, IT, GST
  - Submit fake bids in multiple central govt and state govt tenders
  - Extort monies for submitting fake bids through successful bidders
  - Cash Withdrawal in excess of Rs. 1.40 Crores from these monies
  - HAWALA of Rs. 30 Lakhs through Dubai in another FAKE COMPANY & Account
  - Daily trading of Drugs to make more money through this extortion money
  - Failure to comply with ROC, MCA, IT, GST because company was fake anyway
  
  - Quid pro quo to make Crores, do hawala, consume and encourage drugs, money laundering, etc.
  
  - Beat up and break bones of poor staff who was witness to entire crime

Looking forward to arrest of the accused by your offices. Copy marked to Supreme Transport so that they can file appropriate petitions in courts if action is not taken by departments. In courts, do involve ROC, MCA, GST and I.T. as well because the fraud is clear and real.

-X- End -X-



Date: 24.06.2022.

The Joint Director,  
EOB - II,  
Central Bureau of Investigation,  
13<sup>th</sup> Floor, C.B.I. Building,  
Plot No.C-35A, G Block,  
Bandra Kurla Complex, Bandra E,  
Mumbai-400 051.

Respected Sir,

Subject: Complaint against Mr. Ammeet Agarwal, Mr. Kamal Agarwal, Mr. Varun Kakaria and Mr. Ramesh Kakaria.

Mr. Ammeet Agarwal (A.K.A. Amit Agarwal) and Mr. Kamal Agarwal are the promoters of Supreme Transport Organisations Pvt. Ltd and Sangeeta Aviation Services Pvt. Ltd.

Both the companies are not having any genuine business and into fraudulent activities since 2017 such as Fake billing and turnover, collection of GST from Parties and Non payment to Government, Collection of Advances for tenders of Airport Development and non completion of work instead diversion of funds for leisure and filing cases against governments, undue harassment to Government agencies.

Mr. Ammeet Agarwal has raped many girls and has also been arrested in one of the Rape Case. He was recently arrested in April also as he was using diplomat tag since 2017 even when his membership was terminated. He has too many criminal and civil cases against him for monetary fraud, half murder, cheque bounces, bank frauds, GST, Income Tax. Etc

He has also submitted bogus property papers to Axis Bank for obtaining a loan of Rs.12.00 Crs for which the Bank is going to lodge a complaint at CBI soon once court order is received.

Mr. Ammeet has more than Rs. 10 Crores in Cash and Bank Balances which he has stashed secretly with his father Mr. Kamal Agarwal, Mr. Varun Kakaria (His Employee) and Mr. Ramesh Kakaria (Mr. Varun's Father). All these 3 people have been helping Ammeet to evade government authorities and holding his money which are collected fraudulently.

We request you to attach the properties, bank accounts, movable and immovable assets of Mr. Ammeet Agarwal, Mr. Kamal Agarwal, Mr. Varun Kakaria and Mr. Ramesh Kakaria as there are lot of insolvency cases files and coming up against Mr. Ammeet which will require more than Rs.100.00 Crs to be paid to Secured Creditors.

Mr. Varun Kakaria and Mr. Ramesh Kakaria to be charged with Criminal cases to help a fraud man to fool, the government and poor people. These guys have found ways to support Ammeet in forging signatures, providing fake and false information to government to get payment released. They also helped Ammeet to create a fake company Sangeeta Aviation Service Pvt. Ltd. just to deposit payment of Sangeeta Aviation Services Pvt. Ltd. which went into bankruptcy.

We will provide you more documentary evidence against all 4 of the above by 30.07.2022. We have deployed an agency to find all their cash/bank and property details and money trails for evidence.

Your urgent co-operation on the above is highly appreciated.

CC:

- 1) Jt. CP (EOW), Mumbai Police.
- 2) Commissioner of G.S.T., Mumbai.
- 3) Principal Commissioner of Income Tax-11, Mumbai.

## Index Entry

ಕ್ರಮಾಂಕ	(ಎ) ಅಭಿಯ ವಿವರ	ನಿರ್ವಹಣಾ ಇದಿಯ ದಿನಾಂಕ	(ಬಿ) ದಾಖಲೆ ಮಾಡಿದ ಮತ್ತೆ ಮೌಲ್ಯ (in Rs.)	ಕೆಳಗಾದರೆ ಹೆಸರು ಬರೆದು ಕೊಟ್ಟವರು	ಸಂಪುಟ ಸಿ. ಡಿ. ಸಂಖ್ಯೆ	ಪುಟ	ದಾಖಲೆ ಮಾಡಿದ ಉಲ್ಲೇಖ
(1)	(2)	(3)	(4)	(5)	(7)	(8)	(9)
1	<p>Banaswadi Banaswadi Property Schedule Description: (LAND MARK) Property bearing Municipal New No.15/1, situated at 9th A Main Road, Banaswadi, Bengaluru, Ward No.88, having PID No.88-245-15/1, Bengaluru, Previously known as Property being Western Portion of BMP Khatha Property No.New 15 at 9th Main Road, Banaswadi, Bengaluru, Ward No.88 (Old as H L No. 1085/1, Dadda Banaswadi Village, K R Puram Hobli, Bengaluru South Taluk, Bengaluru). Measuring on the Eastern Side 49 ft, on the Western Side 40 ft, on the Northern Side 40 ft., on the Southern Side 40 ft. 1st (EAST) Portion of Property belonging to R.Chandra Reddy (WEST) Road (SOUTH) Private Property (NORTH) Road&gt;Note: (Schedule A: ) Property bearing Municipal New No.15/1, situated at 9th A Main Road, Banaswadi, Bengaluru, Ward No.88, having PID No.88-245-15/1, Bengaluru, Previously known as Property being Western Portion of BMP Khatha Property No.New 15 at 9th Main Road, Banaswadi, Bengaluru, Ward No.88 (Old as H L No.1085/1, Dadda Banaswadi Village, K R Puram Hobli, Bengaluru South Taluk, Bengaluru). Measuring on the Eastern Side 49 ft, on the Western Side 40 ft, on the Northern Side 40 ft., on the Southern Side 40 ft, totally measuring 1780 Sqft, consists of 4 Sais of AC Sheet roofed shed.</p> <p>Liability Details:</p>	24/09/2015	<p>Article Name:Sale Market Value: 4530975 Consideration Amount: 7200000</p>	<p>Anand Bansal S/o Late Gangaram . . . Anil Gupta S/o Indersain Gupta . . . Ritu Gang W/o Anil Gupta . . . Usha Bansal W/o Anand Bansal . . . Agrawal . . .</p>	BNSD388	11	BNS-1-09218-2015-16

ONLY FOR INFO

## Index Entry

ಕ್ರಮಾಂಕ	(ಎ) ಆಸ್ತಿಯ ವಿವರ	ನಿರ್ವಹಣಾ ಇತಿಹಾಸ ದಿನಾಂಕ	(ಬಿ) ದಾಖಲಾವೆಚ್ಚಿನ ಸ್ವರೂಪ ಮತ್ತು ಮೌಲ್ಯ (In Rs.)	ಚಟುವಟಿಕೆಗಳು	ಚಟುವಟಿಕೆಗಳ ವಿವರ	ಸಂಖ್ಯೆ	ಪುಟ	ದಾಖಲಾವೆಚ್ಚಿನ ಉಲ್ಲೇಖ
(1)	(2)	(3)	(4)	(5)	(6)	(7)	(8)	(9)
1	<p><b>Banaswadi Banaswadi</b>                      Property Schedule Description: (LAND MARK) Property bearing Municipal New No.15/1, situated at 9th A Main Road, Banaswadi, Bengaluru, Ward No.88, having PID No.88-245-15/1, Bengaluru. Previously known as Property being Western Portion of BMP Khatha Property No.New 15 at 9th Main Road, Banaswadi, Bengaluru, Ward No.88 (Old as H L No. 1085/1, Dodda Banaswadi Village, K R Puram Hobli, Bengaluru South Taluk, Bengaluru). Measuring on the Eastern Side 49 ft., on the Western Side 40 ft., on the Northern Side 40 ft., on the Southern Side 40 ft., tot (EAST) Portion of Property belonging to R.Chandra Reddy (WEST) Road (SOUTH) Private Property (NORTH) Road/Note: (Schedule A.) Property bearing Municipal New No.15/1, situated at 9th A Main Road, Banaswadi, Bengaluru, Ward No.88, having PID No.88-245-15/1, Bengaluru, Previously known as Property being Western Portion of BMP Khatha Property No.New 15 at 9th Main Road, Banaswadi, Bengaluru, Ward No.88 (Old as H L No. 1085/1, Dodda Banaswadi Village, K R Puram Hobli, Bengaluru South Taluk, Bengaluru). Measuring on the Eastern Side 49 ft., on the Western Side 40 ft., on the Northern Side 40 ft., on the Southern Side 40 ft., totally measuring 1780 Sqft. consists of 4 Sqs of AC Sheet roofed shed.</p>	24/09/2015	Article Name: Sale Market Value: 4530975 Consideration Amount: 7200000	Anand Bansal S/o Late Gangaram Anil Gupta S/o Indersain Gupta Ritu Garg W/o Anil Gupta W/o Anand Bansal	M/s. Supreme Transport Organisation Pvt. Ltd Rep by Its Joint Managing Director, Mr. Vimal Kumar Agrawal . . .	BNSD388	11	BNS-1-09218-2015-16

ONLY FOR INFO

ಈ ದಸ್ತಾವೇಜು.....(.....ಪುಟಗಳನ್ನು ಹೊಂದಿದೆ.....)  
ಒಂದನೇ ಪುಟದ ದಸ್ತಾವೇಜು ನಂಟು.....9.218.....  
2015-2016

1

**ABSOLUTE SALE DEED**

**THIS DEED OF ABSOLUTE SALE** is made and executed on this **24<sup>th</sup> Day of September, Two Thousand Fifteen (24-09-2015)** at Bangalore **BY and BETWEEN:**

**1.Sri. ANAND BANSAL**, Aged about 49 years,  
S/o Late.Gangaram,  
PAN ; ADEPB4510D.

**2.Smt. USHA BANSAL**, Aged about 45 years,  
W/o. Sri. Anand Bansal,  
PAN; ADGPB3565N.

**3. Sri.ANILGUPTA**, Aged about 44 years,  
S/o Sri.Indersain Gupta,  
PAN; ABLPG5295P.

**4. Smt. RITU GARG**, Aged about 41 years,  
W/o Sri. Anil Gupta,  
PAN; AELPG4246F.

All are residing at : No.25, 9<sup>th</sup> B main, 80 Feet Road,  
Chairman Layout, HRBR Layout, Banaswadi, Bangalore – 560 043.

Hereinafter referred to as the **VENDORS** (which term shall be deemed to mean and include their heirs, executors, legal representatives, successors, administrators and assigns etc.) of the **ONE PART ;AND IN FAVOUR OF :**

**M/s- SupremeTransport Organisation Pvt. Ltd**(PANNo;AAMCS0611A) having registered office at 5/B-34 Akshya Mittal Industrial Estate, M V Road, Andheri (E)-Mumbai -400059 (MH) Represented by Its Joint Managing Director **Mr. VIMAL KUMAR AGRAWAL**.

Hereinafter referred to as the **PURCHASER/COMPANY** (which term shall be deemed to mean and include its executors, legal representatives, administrators and assigns etc.) of the **OTHER PART**.

**WHEREAS** the VENDORS herein are the absolute owners of the immovable property bearing Municipal New No.15/1, Situated at 9<sup>th</sup> A Main Road, Banaswadi, Bangalore, Ward No.88, PID No.88-245-15/1, Bangalore, previously known as Property being Western Portion of BMP Khatha Property No. New.15, at 9<sup>th</sup> Main Road, Banaswadi, Bangalore, Ward No.88, (Old as H.L.No.1085/1, Dodda Banaswadi Village, K.R.Puram Hobli, Bangalore South Taluk, Bangalore, which is morefully described in the Schedule hereunder and hereinafter referred to as the **"SCHEDULE PROPERTY"**, is owned & possessed by the Vendors.

Anand Bansal

For **SUPREME TRANSPORT ORGANISATION PVT. LTD.**

Ush Bansal

Vimal Agrawal

Director

Ush Bansal Ritu Garg

ನೀವು ಪುಟದ ದಸ್ತಾವೇಜು ಸಂಖ್ಯೆ 9218  
2015-2016



ಕರ್ನಾಟಕ ಸರ್ಕಾರ  
ನೋಂದಣಿ ಹಾಗೂ ಮುದ್ರಾಂಕ ಇಲಾಖೆ  
Department of Stamps and Registration

ಪ್ರಮಾಣ ಪತ್ರ

1957 ರ ಕರ್ನಾಟಕ ಮುದ್ರಾಂಕ ಕಾಯ್ದೆಯ ಕಲಂ 10 ಎ ಅಡಿಯಲ್ಲಿಯ ಪ್ರಮಾಣ ಪತ್ರ

ಶ್ರೀ M/s. Supreme Transport Organisation Pvt. Ltd Rep by its Joint Managing Director. Mr. Vimal Kumar Agrawal , ಇವರು 403200.00 ರೂಪಾಯಿಗಳನ್ನು ನಿಗದಿತ ಮುದ್ರಾಂಕ ಶುಲ್ಕವಾಗಿ ಪಾವತಿಸಿರುವುದನ್ನು ದೃಢೀಕರಿಸಲಾಗಿದೆ

ಪ್ರಕಾರ	ಮೊತ್ತ (ರೂ.)	ಹಣದ ಪಾವತಿಯ ವಿವರ
ಇತರೆ ಬ್ಯಾಂಕ್ ಡಿ.ಡಿ.	403200.00	DD No.010613, Dt.23/09/2015, HDFC Bank, Bengaluru
ಒಟ್ಟು :	403200.00	

ಸ್ಥಳ : ಬಾಣಸವಾಡಿ

ದಿನಾಂಕ : 24/09/2015

ಉಪ-ನೋಂದಣಿ ಮತ್ತು ಯುಕ್ತ ಅಧಿಕಾರಿ  
ಉಪ ನೋಂದಣಿ ಅಧಿಕಾರಿ  
ಶಿವಾಜಿನಗರ (ಬಾಣಸವಾಡಿ)  
ಬೆಂಗಳೂರು - 560 043

Designed and Developed by C- DAC ,ACTS Pune.

THE SEAL OF THE SUPREME TRANSPORT ORGANISATION PVT. LTD.

ನೀ ಪುಟದ ದಸ್ತಾವೇಜು ಸಂಖ್ಯೆ 9818  
2013-2016

2

Whereas Sri.R.Chandra Reddy S/o Late. Ramaswamy, have acquired the rights and titles over the schedule property by way of Family Partition Deed dated 25.11.1999 bearing document No.6388/1999-2000 of Book No. I registered on 24.01.2000 in the office of the Sub Register, Krishnarajapura, Bangalore.

And whereas further Sri.R.Chandra Reddy along with his family members sold the schedule property to the vendors herein and have registered the same through Deed of Absolute Sale bearing document No.KRI-1-31788-2006-07, of Book No. I, Stored In CD No.KRID282, dated 24-01-2007, in the office of the Sub Register, K.R.Puram, Bangalore.

**AND WHEREAS**, the Vendors herein having acquired the schedule property in the manner referred to above have been in Un-interrupted peaceful possession and enjoyment of the same as its absolute owners thereof by paying necessary cesses and taxes to the concerned authority without any let or hindrance from any person or persons.

**AND WHEREAS**, the vendors for their legal and family necessity, have negotiated, agreed and decided to sell the Schedule Property, to the PURCHASER/COMPANY by making the representation that;

- That the VENDORS are the absolute owners of the schedule property and their title thereto is good, marketable and subsisting and that no one else has any right, title, interest or share in the schedule property.
- That the schedule property is not subject to any other encumbrances, liability, attachments, minor claims, court order or charges of any kind.
- That the schedule property is not a property in respect of which there is a prohibition against sale and that there is no bar or prohibition for the VENDORS to hold, acquire or sell the schedule property to the PURCHASER/COMPANY.
- That all original records pertaining to the Schedule Property stands in the name of the VENDORS.

**AND WHEREAS**, pursuant to successful negotiation with the PURCHASER/COMPANY herein the VENDORS have agreed to sell the Schedule Property, free from all encumbrances, charges, liens, court attachments, maintenance, claims, demands, etc., for a total sale consideration of **Rs.72,00,000/- (Rupees Seventy Two Lakh Only)**.

**AND WHEREAS**, on faith and assurances of the VENDORS that the Schedule Property is free from all kinds of charges, court attachments, liens, etc., the PURCHASER/COMPANY has agreed to purchase the Schedule Property for a total sale consideration of **Rs.72,00,000/- (Rupees Seventy Two Lakh Only)**.

Amanat Bansal  
Ushu Bansal for the Govt

For SUPREME TRANSPORT ORGANISATION P.O. LTD.

Jinal Agrawal  
Director

...ನೇ ಪುಟದ ದಸ್ತಾವೇಜು ಸಂಖ್ಯೆ 2015-2016

2015-2016



Print Date & Time : 24-09-2015 03:06:30 PM

ದಸ್ತಾವೇಜು ಸಂಖ್ಯೆ : 9218

ಬಾಣಸವಾಡಿ ದಲ್ಲಿರುವ ಉಪನೋಂದಣಾಧಿಕಾರಿ ಶಿವಾಜಿನಗರ ರವರ ಕಚೇರಿಯಲ್ಲಿ ದಿನಾಂಕ 24-09-2015 ರಂದು 01:58:08 PM ಗಂಟೆಗೆ ಈ ಕೆಳಗೆ ವಿವರಿಸಿದ ಶುಲ್ಕದೊಂದಿಗೆ

ಕ್ರಮ ಸಂಖ್ಯೆ	ವಿವರ	ರೂ. ವೆ
1	ನೋಂದಣಿ ಶುಲ್ಕ	72000.00
2	ಸೇವಾ ಶುಲ್ಕ	390.00
	ಒಟ್ಟು :	72390.00

ಶ್ರೀ M/s. Supreme Transport Organisation Pvt. Ltd Rep by its Joint Managing Director. Mr. Vimal Kumar Agrawal ಇವರಿಂದ ಹಾಜರ ಮಾಡಲ್ಪಟ್ಟಿದೆ

ಹೆಸರು	ಫೋಟೊ	ಹೆಚ್ಚಿಟ್ಟನ ಗುರುತು	ಸಹಿ
ಶ್ರೀ M/s. Supreme Transport Organisation Pvt. Ltd Rep by Its Joint Managing Director. Mr. Vimal Kumar Agrawal			Vimal Agrawal

ಶಬ್ದ ರಚನಾಧಿಕಾರಿ  
ಉಪ ನೋಂದಣಾಧಿಕಾರಿ  
ಶಿವಾಜಿನಗರ (ಬಾಣಸವಾಡಿ)  
ಬೆಂಗಳೂರು - 560 043

ಬರೆದುಕೊಟ್ಟಿದ್ದಾಗಿ ಒಪ್ಪುರುತ್ತಾರೆ

ಕ್ರಮ ಸಂಖ್ಯೆ	ಹೆಸರು	ಫೋಟೊ	ಹೆಚ್ಚಿಟ್ಟನ ಗುರುತು	ಸಹಿ
1	M/s. Supreme Transport Organisation Pvt. Ltd Rep by Its Joint Managing Director. Mr. Vimal Kumar Agrawal . (ಬರೆಸಿಕೊಂಡವರು)			Vimal Agrawal
2	Anand Bansal S/o Late Gangaram . (ಬರೆದುಕೊಡುವವರು)			Anand Bansal

ಶಬ್ದ ರಚನಾಧಿಕಾರಿ  
ಉಪ ನೋಂದಣಾಧಿಕಾರಿ  
ಶಿವಾಜಿನಗರ (ಬಾಣಸವಾಡಿ)  
ಬೆಂಗಳೂರು - 560 043

.....ನೇ ಪ್ರತಿಷ್ಠಿತ ದಸ್ತಾವೇಜು ಸಂಖ್ಯೆ.....೨೨೧೬.....  
2013-2016

3

**NOW THIS SALE DEED WITNESSETH AS FOLLOWS:-**

**WHEREAS**, the VENDORS shall sell unto the PURCHASER/COMPANY, all that piece and parcel of the Schedule Property in its entirety together with easements, hereditaments, rights and things and items which are permanently fastened and attached to the schedule land and all other attributes and valuables situated in the schedule property in favour of the PURCHASER/COMPANY, along with all the aforementioned attributes. The VENDORS have agreed to sell the schedule property to the PURCHASER/COMPANY for a sale consideration of **Rs.72,00,000/- (Rupees Seventy Two Lakh Only)** and the PURCHASER/COMPANY has paid the entire sale consideration to the VENDORS in the following manner :



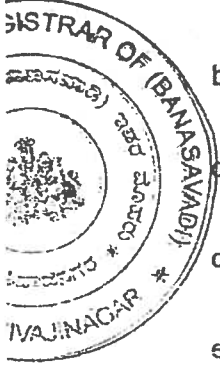

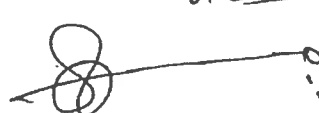

- a) **Rs.10,00,000/- (Rupees Ten Lakh Only)** by way of Cheque bearing No.001693, dated 11-08-2015, drawn on Kotak Mahindra Bank Ltd., Bangalore, issued in favour of Mr. Anand Bansal.
- b) **Rs.10,00,000/- (Rupees Ten Lakh Only)** by way of Cheque bearing No.001694, dated 11-08-2015, drawn on Kotak Mahindra Bank Ltd., Bangalore, issued in favour of Mrs. Usha Bansal.
- c) **Rs.10,00,000/- (Rupees Ten Lakh Only)** by way of Cheque bearing No.001695, dated 11-08-2015, drawn on Kotak Mahindra Bank Ltd., Bangalore, issued in favour of Mr. Anil Gupta.
- d) **Rs.10,00,000/- (Rupees Ten Lakh Only)** by way of Cheque bearing No.001696, dated 11-08-2015, drawn on Kotak Mahindra Bank Ltd., Bangalore, issued in favour of Mr. Ritu Gupta.
- e) **Rs.5,00,000/- (Rupees Five Lakh Only)** by way of Cheque bearing No.001721, dated 25-08-2015, drawn on Kotak Mahindra Bank Ltd., Bangalore, issued in favour of Mr. Anand Bansal.
- f) **Rs.5,00,000/- (Rupees Five Lakh Only)** by way of Cheque bearing No.001722, dated 25-08-2015, drawn on Kotak Mahindra Bank Ltd., Bangalore, issued in favour of Mrs. Usha Bansal.
- g) **Rs.5,00,000/- (Rupees Five Lakh Only)** by way of Cheque bearing No.001723, dated 25-08-2015, drawn on Kotak Mahindra Bank Ltd., Bangalore, issued in favour of Mr. Anil Gupta.
- h) **Rs.5,00,000/- (Rupees Five Lakh Only)** by way of Cheque bearing No.001724, dated 11-08-2015, drawn on Kotak Mahindra Bank Ltd., Bangalore, issued in favour of Mrs. Ritu Gupta.
- i) **Rs.2,82,000/- (Rupees Two Lakh Eighty Two Thousand Only)** by way of Cheque bearing No.001744, dated 15-09-2015, drawn on Kotak Mahindra Bank Ltd., Bangalore, issued in favour of Mr. Anand Bansal.
- j) **Rs.2,82,000/- (Rupees Two Lakh Eighty Two Thousand Only)** by way of Cheque bearing No.001745, dated 15-09-2015, drawn on Kotak Mahindra Bank Ltd., Bangalore, issued in favour of Mrs. Usha Bansal.
- k) **Rs.2,82,000/- (Rupees Two Lakh Eighty Two Thousand Only)** by way of Cheque bearing No.001746, dated 15-09-2015, drawn on Kotak Mahindra Bank Ltd., Bangalore, issued in favour of Mr. Anil Gupta.

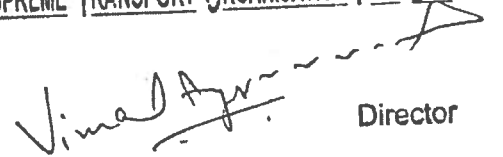

Anand Bansal  
  
Ush Bansal  
Anil Gary

For **SUPREME TRANSPORT ORGANISATION PVT. LTD.**

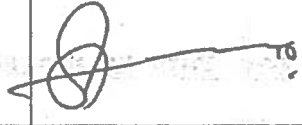
Vimal Agrawal  
  
Director

ಕ್ರಮ ಸಂಖ್ಯೆ	ಹೆಸರು	ಫೋಟೊ	ಹೆಚ್ಚಿನ ಗುರುತು	ಸಹಿ
3	Usha Bansal W/o Anand Bansal . (ಬರೆದುಕೊಡುವವರು)			Usha Bansal
4	Anil Gupta S/o Indersaln Gupta . (ಬರೆದುಕೊಡುವವರು)			
5	Ritu Garg W/o Anil Gupta . (ಬರೆದುಕೊಡುವವರು)			Ritu Garg

...ನೇ ಪುಟದ ದಸ್ತಾವೇಜು ಸಂಖ್ಯೆ... 9248...  
2015-2016

  
ಸಬ್ ರಜಿಸ್ಟ್ರಾರ್  
ಉಪ ನೋಂದಣಾಧಿಕಾರಿ  
ವಿವಾಹನಗರ (ಬಾಣಸಹಾಡಿ)  
ಬೆಂಗಳೂರು - 560 043  
THE SEAL OF THE SUB-R  
\* ಸಬ್ ನೋಂದಣಾಧಿಕಾರಿ \*  
\* S.R. \*

.....ನೀ ಪ್ರತಿ ದಸ್ತಾವೇಜು ಸಂಖ್ಯೆ ೨೨೧೮  
2013-2016

4

- l) **Rs.2,82,000/- (Rupees Two Lakh Eighty Two Thousand Only)** by way of Cheque bearing No.001747, dated 15-09-2015, drawn on Kotak Mahindra Bank Ltd., Bangalore, issued in favour of Mrs. Ritu Gupta.
- m) **Rs.72,000/- (Rupees Seventy Two Thousand Only)** has been Paid towards TDS in the form of (18,000 X 4 = 72,000), through acknowledgment Nos.AC3667484, AC3667403, AC3667521, AC3667602, dated 24-09-2015.

The above said amounts has been Paid before the following witnesses. The receipt of the said sale consideration amount is hereby unequivocally acknowledged by the VENDORS herein.

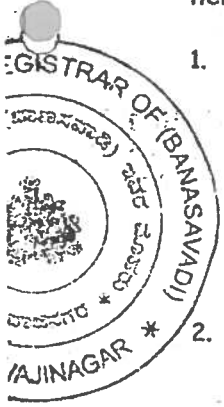

1. In pursuance of this indenture and In consideration of the sale consideration referred to ante, the VENDORS does hereby grant, convey, transfer, handover physical possession, assign, alienate and makeover the schedule Property in its entirety by way of absolute sale all the estate, right, title and interest, claims and equities whatsoever the VENDORS hitherto had and enjoyed in, to upon or in respect of the Schedule Property and all and singular benefits hereinbefore expressed which is hereunder sold and conveyed to the PURCHASER/COMPANY absolutely and forever free from all encumbrances.
2. The VENDORS does hereby unequivocally acquits them self of all rights, title and interest whether individual, or joint, singular or gregarious hitherto enjoyed by them and absolutely transfer and make over all such rights, titles and interest they have enjoyed in respect of the schedule property in favour of the PURCHASER/COMPANY.
3. The VENDORS further covenants with the PURCHASER/COMPANY that the Schedule Property sold to the PURCHASER/COMPANY under this Deed is the absolute Property of the VENDORS and none others have any manner of right, title and interest over the same to sell, grant, assign, transfer to the PURCHASER/COMPANY to **HAVE** and to **HOLD** the same absolutely, peacefully forever with all easements, privileges, hedges, appurtenant, things which are fixed therein and subservient thereto, etc.
4. As has been acknowledged by the VENDORS in anterior portion, the sale consideration is confirmed at **Rs.72,00,000/- (Rupees Seventy Two Lakh Only)** and the VENDORS does hereby unequivocally acquits the PURCHASER/COMPANY from making any further payment towards the sale consideration or towards any other expenses, arrears of taxes, cesses in relation to any other.

For SUPREME TRANSPORT ORGANISATION PVT. LTD.

Anand Bansal

Ushu Bansal

Ritu Gupta

Director

ಗುರುತಿಸುವವರು

1 ನೇ ಪುಸ್ತಕದ ದಸ್ತಾವೇಜು ಸಂಖ್ಯೆ 10218  
2015-2016

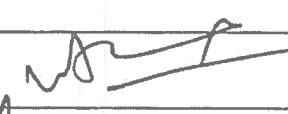
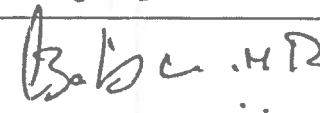
ಕ್ರಮ ಸಂಖ್ಯೆ	ಹೆಸರು ಮತ್ತು ವಿಳಾಸ	ಸಹಿ
1	Kamal Agarwal No.5, 1st Cross, Opp SBI Bank, Horamavu Main Road, Bengaluru-43	
2	Babu M.R No.31/A, 9th B Main, 1st Block, HRBR layout, Kalyan Nagar, Bengaluru-43	

ಸಬ್ ರಜಿಸ್ಟ್ರಾರ್  
ಉಪ ನೋಂದಣಾಧಿಕಾರಿ  
ಶಿವಾಜಿನಗರ (ಬಾಣಸವಾಡಿ)  
ಬೆಂಗಳೂರು - 560 043

  
1 ನೇ ಪುಸ್ತಕದ ದಸ್ತಾವೇಜು  
ನಂಬರ BNS-1-09218-2015-16 ಆಗಿ  
ಸಿ.ಡಿ. ನಂಬರ BNSD388 ನೇ ಧರಲ್ಲಿ  
ದಿನಾಂಕ 24-09-2015 ರಂದು ನೋಂದಾಯಿಸಲಾಗಿದೆ

ಉಪನೋಂದಣಾಧಿಕಾರಿ ಶಿವಾಜಿನಗರ (ಬಾಣಸವಾಡಿ)  
**ಕೆ.ವಿ.ರವಿಕುಮಾರ್**  
ಉಪ ನೋಂದಣಾಧಿಕಾರಿ  
ಶಿವಾಜಿನಗರ (ಬಾಣಸವಾಡಿ), ಬೆಂಗಳೂರು - 43.



Designed and Developed by C-DAC, ACTS, Pune

.....ನೀ ಪುಟದ ದಸ್ತಾವೇಜು ಸಂಖ್ಯೆ..... 9218  
2015-2016

5

5. The VENDORS does hereby assures the PURCHASER/COMPANY that the Schedule Property or any portion thereof is not subject to any dispute in any court of law nor the schedule property or any portion thereof is subjected to any attachment of any court or by operation of any law and or by agreement inter-vivos and every portion of the same enjoys absolute alienable disposition.

6. The VENDORS acknowledges and admits that they have put the PURCHASER/COMPANY in **ABSOLUTE POSSESSION** of the entire schedule property and acquits themselves of possession and further assures that, the PURCHASER/COMPANY shall hold and enjoy the schedule property forever free from any let, hindrance, interruption or disturbance by the VENDORS or any person claiming through or under him.

The Vendors hereby covenants and agree, with the Purchasers to save harmless and indemnify the Purchasers against all losses or damages which they might sustain or incur in respect of any encumbrances made by the Vendors or any of their predecessors in title or in respect of any other claims that may be put forward to the schedule property or in respect of any arrears of corporation taxes, rates, cess, assessments or any other charges or lien or any attachments made by any Court of law or on account of any defect of title (latent or patent) of the Vendors to the Schedule Property.

8. Further the VENDORS assures that the taxes, cesses, charges levies and such revenue outgoings charges, or chargeable levied or leviable by the Government, State or Central and / or other autonomous body or bodies competent to levy has been paid.

9. The VENDORS further assures the PURCHASER/COMPANY that the Schedule property has not been subjected to any earlier contract of sale or lease or mortgage and the schedule property does not suffer from any liability of pre-emption and the VENDORS have not been a party to any contract whereby that, they have been prevented from conveying the schedule property to the PURCHASER/COMPANY nor the schedule property or any portion thereof is servient to any dominant servitude or easement.

10. The VENDORS have this indenture conveyed unto the PURCHASER/COMPANY the entire schedule property and hereby recognizes, admit and declare that the PURCHASER/COMPANY has obtained all the required title.

11. The VENDORS undertakes to execute all the necessary forms, applications or deeds, from time to time, which are required to perfect the title granted under this Indenture or for any other lawful purpose.

For SUPREME TRANSPORT ORGANISATION PVT. LTD.

Anand Bansal

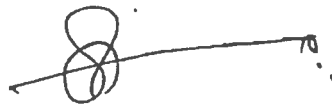

Ushu Bansal

Jyoti Garg



Director



...ದಿನೇ ಪುಟದ ದಸ್ತಾವೇಜು ಸಂಖ್ಯೆ... 9218

2015-2016

6

12. The VENDORS have handed over to the PURCHASER/COMPANY all the copies of relevant documents pertaining to the title deeds of the Schedule Property.
13. The entire expenses of stamp duty, registering, documentation and other incidental expenses are borne by the PURCHASER/COMPANY.
14. The Vendors herein have no objection for the PURCHASER/COMPANY to get the Katha of Schedule property transferred into PURCHASER/COMPANY name. Further, the PURCHASER/COMPANY are hereby authorized to get transferred to PURCHASER/COMPANY name all relevant licenses, documents and other necessary permissions which are now standing in the name of the Vendors at the respective Statutory Authorities along with the Deposits.

**SCHEDULE PROPERTY**

All that piece and parcel of the residential house property bearing Municipal New No.15/1, Situated at 9<sup>th</sup> A Main Road, Banaswadi, Bangalore, Ward No.88, having PID No.88-245-15/1, Bangalore, previously known as Property being Western Portion of BMP Katha Property No. New.15, at 9<sup>th</sup> Main Road, Banaswadi, Bangalore, Ward No.88, (Old as H.L.No.1085/1, Dodda Banaswadi Village, K.R.Puram Hobli, Bangalore South Taluk, Bangalore),

**Measuring as follows;**

On the Eastern Side : 49 Feet,

On the Western Side : 40 Feet,

On the Northern Side : 40 Feet,

On the Southern Side : 40 Feet.

In all total measuring 1780 Sq Ft.,

For SUPREME TRANSPORT ORGANISATION PVT. LTD.

Anand Bansal  

Ushu Bansal  
Jitu Garg

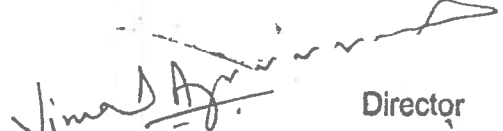
  
Director

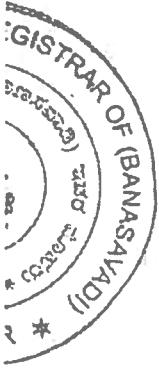

ನೋ ಪುಟದ ದಸ್ತಾವೇಜು ಸಂಖ್ಯೆ ೧೨೧೮

2015-2016

7

**And presently bounded on the :**



- East by : Portion of Property belonging to Sri.R. Chandra Reddy,  
West by : Road,  
North by : Road,  
South by : Private Property.

The schedule property consists of 4 squares of A.C Sheet roofed Shed, constructed with mud walls, mud flooring, jungle wood, without any other civic amenities. The market value of the Schedule Property is **Rs.72,00,000/- (Rupees Seventy Two Lakh Only)**.

**IN WITNESS WHEREOF**, the parties to this deed have affixed their respective signatures, on the date, month and year first above mentioned, in the presence of the following witnesses.

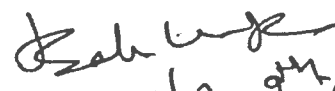
**WITNESSES:**

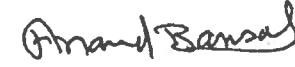
-   
Kamal Agarwal  
5 1st cross opp  
Sri Banic  
Haramma main  
Bangalore-43
-   
No 31/A, 9th B main  
1st block,  
HRBR layout,  
Kalyan Nagar  
Bangalore-43.

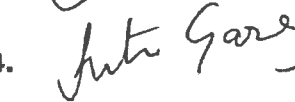
-   
Anand Bansal
-   
Ushe Bansal
-   
Jitu Garg
-   
Jitu Garg

**VENDORS**

For **SUPREME TRANSPORT ORGANISATION PVT. LTD.**

**PURCHASER/COMPANY**

Director

Rep by its Joint Managing Director

**Drafted By Me**



**G. KRISHNA REDDY, B.A., LLB.**  
**ADVOCATE**

Roll No. 676/84

No. 244, 7th 'B' Main, HRBR 1st Block,  
Kalyan Nagar, Bangalore - 560 043

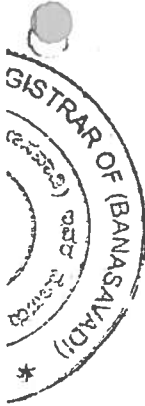



ಕರ್ನಾಟಕ ಸರ್ಕಾರ

ನೋಂದಣಿ ಹಾಗೂ ಮುದ್ರಾಂಶ ಇಲಾಖೆ

ಪ್ರವೃತ್ತಿ 15

(78 ನೇ ಪ್ರಕರಣ ಹಾಗೂ 110ನೇ ನಿಯಮವನ್ನು ನೋಡಿ)

Receipt No : 7489

ಕಛೇರಿ : ಬಾಣಸವಾಡಿ

Original

ದಿನಾಂಕ : 24/09/2015

ಶ್ರೀ M/s. Supreme Transport Organisation Pvt. Ltd Rep by Its Joint Managing Director. Mr. Vimal Kumar Agrawal - ಇವರಿಂದ ಸ್ವೀಕರಿಸಲಾಗಿದೆ  
2015 - 16 ವರ್ಷದ '9218 ಸಂಖ್ಯೆಯ ಆಜ್ಞೆಗಾಗಿ

ರೂ. ಪೈ.

ಮುದ್ರಾಂಶ ಶುಲ್ಕ

40.00

ಒಟ್ಟು :

40.00

Rs. 40.00 ನಗದಾಗಿ Paid by Cash

ನಗದಾಗಿ ಸ್ವೀಕರಿಸಿದ ಮುದ್ರಾಂಶ ಶುಲ್ಕ :

+

0

ಒಟ್ಟು :

40.00

( ಅಕ್ಷರದಲ್ಲಿ ) ( ರೂ. ಸಲವತ್ತು )

ಸಬ್ ರೆಜಿಸ್ಟ್ರಾರ್ ಬಾಣಸವಾಡಿ

Designed and Developed by C- DAC ,ACTS Pune.

ಉಪ ನೋಂದಣಾಧಿಕಾರಿ  
ಶಿವಾಜಿನಗರ (ಬಾಣಸವಾಡಿ)  
ಬೆಂಗಳೂರು - 5610 043



ಕರ್ನಾಟಕ ಸರ್ಕಾರ

ನೋಂದಣಿ ಹಾಗೂ ಮುದ್ರಾಂಶ ಇಲಾಖೆ

ಪ್ರವೃತ್ತಿ 15

(78 ನೇ ಪ್ರಕರಣ ಹಾಗೂ 110ನೇ ನಿಯಮವನ್ನು ನೋಡಿ)

Receipt No : 10087

ಕಛೇರಿ : ಬಾಣಸವಾಡಿ

Original

ದಿನಾಂಕ : 24/09/2015

ಶ್ರೀ M/s. Supreme Transport Organisation Pvt. Ltd Rep by Its Joint Managing Director. Mr. Vimal Kumar Agrawal - ಇವರಿಂದ ಸ್ವೀಕರಿಸಲಾಗಿದೆ  
2015 - 16 ವರ್ಷದ ಪ್ರವೃತ್ತಿ - 1 ಪ್ರವೃತ್ತಿ 9218 ಸಂಖ್ಯೆಯ ಪತ್ರದ ನೋಂದಾವಣೆಗಾಗಿ

ರೂ. ಪೈ.

ನೋಂದಣಿ ಶುಲ್ಕ

72000.00

ಸೇವಾ ಶುಲ್ಕ

390.00

ಒಟ್ಟು :

72390.00

Rs. 390.00 ನಗದಾಗಿ Paid In Cash 72000.00 ಡಿ.ಡಿ.ಮೂಲಕ DD No.010612.

Dt.23/09/2015, HDFC Bank, Bengaluru

ನಗದಾಗಿ ಸ್ವೀಕರಿಸಿದ ಮುದ್ರಾಂಶ ಶುಲ್ಕ :

+

0

ಒಟ್ಟು :

72390.00

( ಅಕ್ಷರದಲ್ಲಿ ) ( ರೂ. ಎಪ್ಪತ್ತೈದು ಸಾವಿರದ ಮೂರು ನೂರು ತೊಂಬತ್ತು )

ಮೇಲಿನ ದಾಖಲೆಯನ್ನು 24/09/2015 ದಿನದಂದು ಓದಿಸಲಾಗುವುದು

ಸಬ್ ರೆಜಿಸ್ಟ್ರಾರ್ ಬಾಣಸವಾಡಿ

Designed and Developed by C- DAC ,ACTS Pune.

ಉಪ ನೋಂದಣಾಧಿಕಾರಿ  
ಶಿವಾಜಿನಗರ (ಬಾಣಸವಾಡಿ)  
ಬೆಂಗಳೂರು - 560 043



Stamp duty Rs. 2910/-

Stamp duty Rs. 2910/-

Corp. tax Rs. 4850/-

-----  
Total Rs. 7760/-  
-----

Witness

This deed is executed at Delhi on 19/4/93  
by sh. sathir singh s/o sh. chhatar singh, vpo: s. Bad paulapur, Distt  
Delhi, General Attorney of sh. ~~XXXXXXXXXXXX~~ Daya and

Shri Rajendra Sharma s/o Mr. P. K. Sharma, Posta Khurd,  
Delhi, vide GPA dt. 13.4.1993 attested by notary public,

contd..2..

*Sathir Singh*

*Sathir Singh*

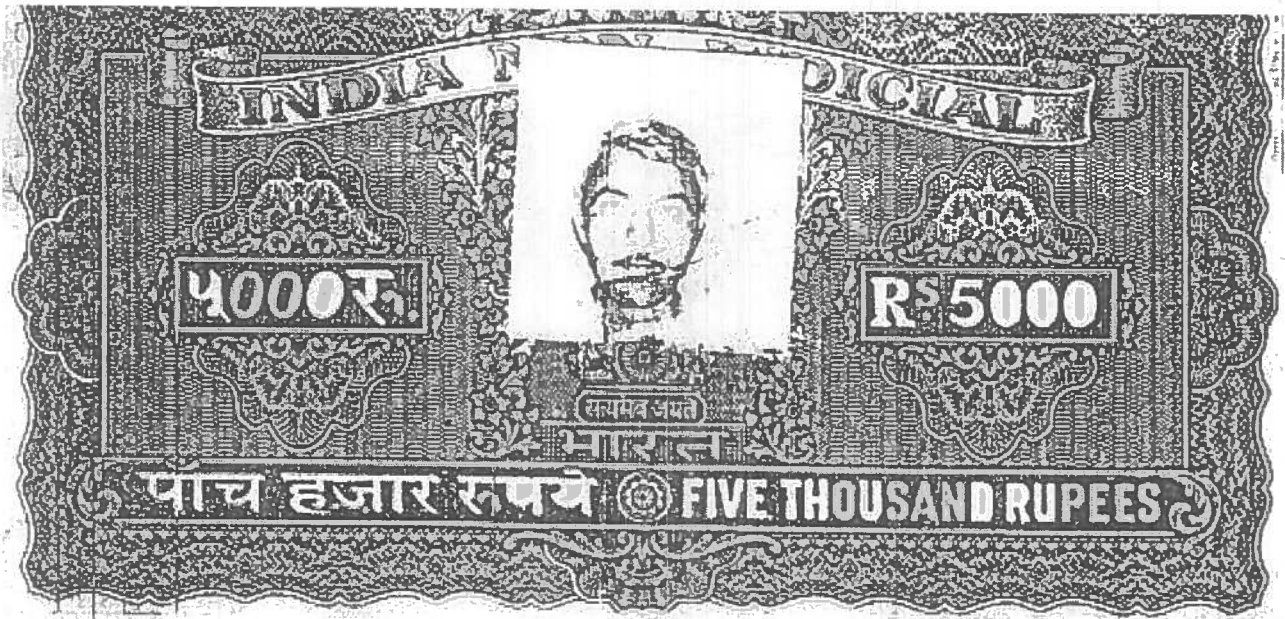

SALE DEED

For a sum of Rs.1,02,000/-

Stamp Duty..Rs.3060/-

Corpn. Tax..Rs.5100/-

Total...Rs.8160/-

THIS DEED OF SALE is made at Delhi on this 19th day  
of April, 1993, by Shri Mohinder Kumar Jain son of Shri Tara  
Chand resident of N-24, C.C.Colony, Delhi hereinafter called  
the 'VENDOR'.....Citizen of India.

*Satyajit*

P/2

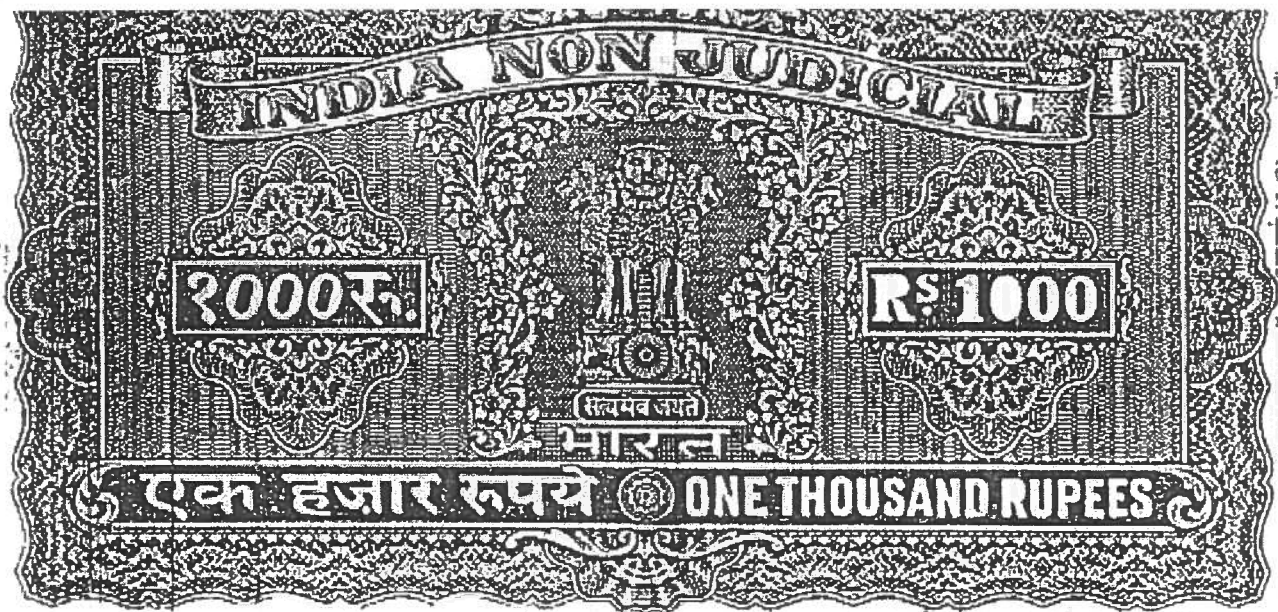

..3..

The expressions of the vendor and the  
vendee both shall mean and include their heirs,  
successors, executors and assigns.

Whereas the vendor is owner, occupiers,  
landlords and in absolute possession of land  
measuring 1 bigha out of khara no. 3/3,  
situated in the area of village Sahibabad Maulat  
pur, Delhi, as per revenue records, in the name of Shri  
Daya <sup>N</sup> and Sharma, who is still alive and he has not  
cancelled his General Power Of Attorney, till date.

..4..

*Satyam*

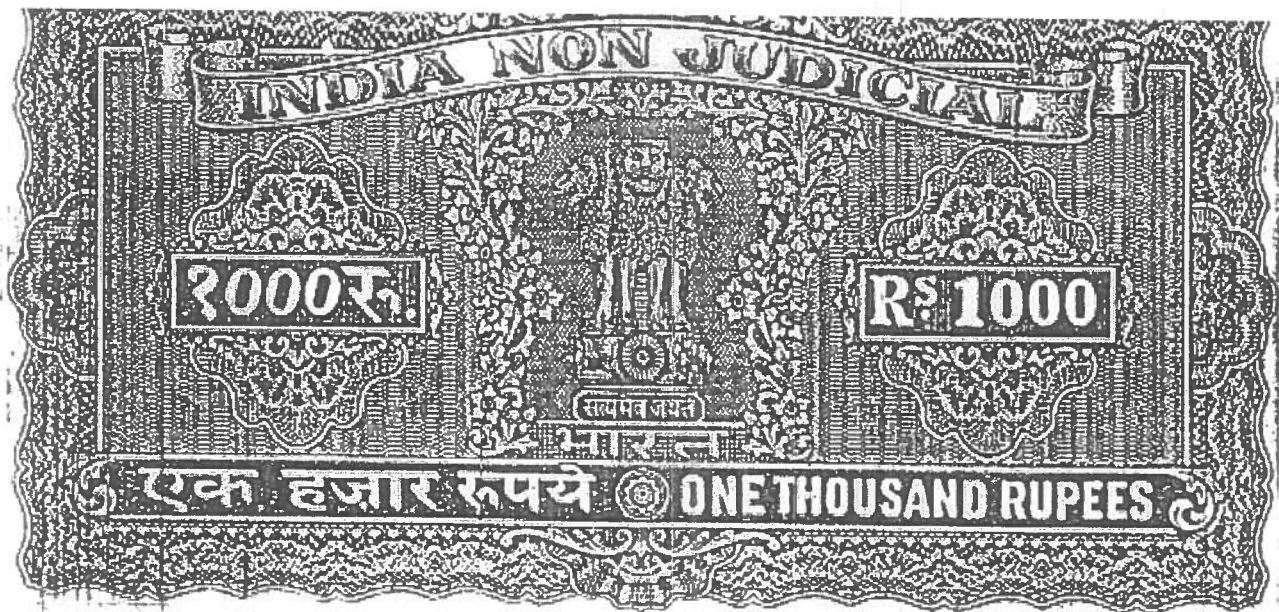

-3-

WHEREAS the vendor is the exclusive owner, Bhumidar and in absolute possession of piece of land measuring 1 Bigha 1 Biswas out of Khasra No. 22/23 (0-12), and 39/3 (0-9), situated in the area of village Shahibabad Daultpur, Delhi-42, as per revenue records.

AND WHEREAS the vendor for his bonafide needs and legal requirements has agreed to sell the above mentioned land unto the vendee, who has also agreed to purchase the same for a total consideration amount of Rs. 1,02,000/- (Rs. one lac two thousand only). The entire consideration amount has been received by the vendor from the vendee in cash in advance, which the vendor hereby again admit and acknowledges before the Sub-Registrar, Delhi.

*Satyajit*

...p/4....

40  
#  
Annexure 23

EXP. OR RS. 97,000/-

(Copy)

Stamp Duty Rs. 2,910/-

Corpn. Tax Rs. 4,850/-

Total Rs. 7,760/-

SALE DEED

This Sale Deed is executed at Delhi on 19/4/93 by SH. Satbir Singh S/o Sh. Chhattar Singh, VPO: S. Bad Daulatpur, Delhi, General Attorney of Shri Daya Chand.

Sharma son of Shri Mai Chand Sharma, R/o VPO: Pooth Khurd, Delhi vide GPA dt. 13.4.1993 attested by notary public, Delhi, hereinafter called the Vendor (citizen of India), in favour of favour of M/s Supreme Transport Organisation at 32, Khanqa Market, Tis Hazari, Delhi, through its Partner Shri Jagdish Chander son of Shri Ramji Lal R/o 47-A, Block A D, Pitam Pura, Delhi, hereinafter called the Vendee (citizen of India)

The expressions of the Vendor and the Vendee both shall mean and include their heirs, successors, executors and assigns.

Whereas the Vendor is owner, occupiers, bhumi-dar and in absolute possession of Land measuring 1 bigha out of Khaska No. 39/3, situated in the area of village Shahbad Daulatpur, Delhi, as per revenue records, in the name of Shri Dayanand

44  
85

SALE DEED FOR A SUM OF RS. 1,00,000/-

Stamp Duty Rs. 3,000/-

Corpn. Tax Rs. 5,000/-  
Total Rs. 8,000/-

SALE DEED

This Sale Deed is executed at Delhi on 11<sup>th</sup> day of September 1996 By Smt. Meenu Rijwani wife of Shri Rakesh Rijwani resident of G-27, C.C. Colony, Delhi, hereinafter called the Vendor, in favour of M/s Supreme Transport Organisation at 32, Khanna Market, Tis Hazari, Delhi, through its Partner Shri Jagdish Chander son of Shri Ramji Lal resident of A-47, Block-AD, Pitam Pura, Delhi-34, hereinafter called the Vendee.

The expressions of the Vendor and the Vendee both shall mean and include their heirs, successors, executors and assigns etc.

Whereas the Vendor is owner, occupier and in absolute possession of Land measuring 1 bigha out of Khastri No. 22/23min, situated in revenue estate of village Shabbat Daulatpur, Delhi, as per revenue records.

And whereas the Vendor in his complete needs and legal

signature has agreed to sell the said land to the Vendee and the

118 98

SALE DEED FOR A SUM OF RS. 1,00,000/-

Stamp Duty Rs. 3,000/-

Corpn. Tax Rs. 5,000/-  
Total Rs. 8,000/-

SALE DEED

This Sale Deed is executed at Delhi on 01<sup>st</sup> day of November 1996 By Shri. Mangal Sein Jain son of Shri Gopal Jain resident of 292, Mukharji Nagar, Ganga Nagar, Rajasthan, hereinafter called the Vendor, in favour of M/s Supreme Transport Organisation at 32, Khanna Market, Tis. Hazari, Delhi, through its karta Shri Jagdish Chander Singh son of Shri Ramji Lal resident of A-47, Block-AD, Pitam Pura, Delhi-34, hereinafter called the Vendee.

The expressions of the Vendor and the Vendee both shall mean and include their heirs, successors, executors and assigns etc.

Whereas the Vendor is owner, occupiers and in absolute possession of Land measuring 1 bigha out of Khasra No. 22/23, situated in revenue estate of village Shahbad Daulatpur, Delhi, as per revenue records.

122 52

**SALE DEED**

For a sum of Rs. 1,02,000/-

Stamp Duty Rs. 3,060/-

Corpn. Tax Rs. 5,100/-

Total Rs. 8,160/-

**SALE DEED**

THIS DEED OF SALE is made at Delhi on this 19<sup>th</sup> day of April, 1993 by Shri S.S. Rana S/o Sh. C.S. Rana, VPO-S. Bad Dautapur, Delhi, GPA of Shri Mohinder Kumar Jain son of Shri Tara Chand resident of N-24, C.C. Colony, Delhi vide GPA dated 16-4-1993 attested by notary public Delhi, hereinafter called the 'VENDOR'..... Citizen of India.

**IN FAVOUR OF:**

M/s Supreme Transport Organisation at 32, Khanna Market, Tis Hazari, Delhi, through its Partner Shri Mahesh Chander son of Shri Ramji Lal resident of 47-A, BIKAD, Pitampura, Delhi, hereinafter called the 'VENDEE'..... Citizen of India.

The expressions of the Vendor and the Vendee shall mean and include their heirs, successors, executors and assigns of the respective parties.

TRUE COPY

126.58

SALE DEED

For a sum of Rs. 1,00,000/-

Stamp Duty Rs. 3,000/-

Corpn. Tax Rs. 5,000/-

Total Rs. 8,000/-

SALE DEED

THIS DEED OF SALE is made at Delhi on this 15<sup>th</sup> day of November, 1996 by Shri Smt. Kanchan Van Thakkar wife of Shri VV Thakkar resident of 107, Gujrat Vihar, Preet Vihar, Delhi, hereinafter called the Vendor, IN FAVOUR OF M/s Supreme Transport Organisation at 32, Kharina Market, Tis Hazari, Delhi, through its karta Shri Jagdish Chander Sihag son of Shri Ramji Lal resident of A/47, AD-Block, Pitampura, Delhi, hereinafter called the Vendee.

The expressions of the Vendor and Vendee both shall mean and include their heirs, successors, executors and assigns, etc.

Whereas the Vendor is the owner, occupier and in absolute possession of agriculture land measuring 1/8<sup>th</sup> bearing Khasra No. 22/23 min situated in revenue estate of village Shahbad Daulatpur, Delhi, as per revenue records.

1/8 COPY

17-03-2022	BI211958	SUPREME TRANSPORT	46,87,900.00	8,564.68CR
30-03-2022	S83245260	NEFT/RBI0902284602406/Gul	26,09,097.00	26,17,661.68CR
04-04-2022	BI699586	SUPREME TRANSPORT	26,09,097.00	8,564.68CR
25-05-2022	S68824201	99999X ACCOUNT MAINTENANCE CHARG	162.26	8,402.42CR
26-07-2022	S75607535	0001045847 NEFT/N207222051636983/NIP	24.00	3,31,018.42CR
27-07-2022	S86382179	0001049613 Charges: NEFT/BKIDN2220896	3,23,278.00	3,30,994.42CR
27-07-2022	S86382179	0001049613 NEFT/BKIDN22208969219/ ID	162.26	7,716.42CR
23-08-2022	S87190658	99999X ACCOUNT MAINTENANCE CHARG		7,554.16CR
TOTAL (Curr. INR) ?			4,72,87,094.34	7,554.16CR

Manager/Chief Manager

Date : 30-08-2022

Signature

\*\*\* 3 pages printed. End of report \*\*\*

48. Pending the hearing and final disposal of this Application, the Applicants pray that this Hon'ble Tribunal be graciously pleased to grant following **Interim Reliefs**:

- a. to restrain the Respondent No 2, 5 & 6 from selling, disposing of, negotiating, alienating, transferring, assigning, encumbering the properties and Assets of the Respondent No. 1 Company or creating any third party right, title or interest in respect of or parting with the possession of the properties and Assets in any manner whatsoever;
- b. to pass an order seizing all the bank accounts of the Company and make a new escrow account for all the transactions to be operated jointly by the Petitioner and Respondent sides representatives restraining the Respondent Nos. 2, 5 and 6 from unilaterally operating any Bank account of Respondent No. 1 Company;
- c. to pass an Order for payment of the directors' remuneration to the Applicants from 01.04.2019 onward.
- d. to pass an Order for forensic audit of the Accounts of the Respondent No. 1 Company on such terms as this Hon'ble Tribunal deem fit and proper and submit the Report to this Hon'ble Tribunal within a period fixed by this Hon'ble Tribunal;
- e. to pass an Order directing Respondent Company, Statutory Auditors, their servants and agents for providing to the Applicants full, free and complete inspection and to furnish copies of all required documents, accounts, records, books, papers and vouchers of the Company with regard to the affairs of the Company and/or the loans and advances accepted/given by the Company from;
- f. to pass an Order restraining from interfering or disturbing the shareholding of the all the Petitioners and Applicants in the

Vinod Ag. ~ ~ ~

For Vinod Ag. ~ ~ ~  
Vinod Ag. ~ ~ ~

- (e) To direct holding of Board meetings and General meeting to approve accounts for last pending years.
- (f) to direct the Respondent No. 2, 5 & 6 and their respective servants, agents and assigns to make a full, free and complete disclosure of all Records and Documents of the Company with regards to the affairs of the Company;
- (g) to pass a perpetual Order of Injunction restraining Respondents No. 2, 5 & 6 from in any manner dealing with, depositing of, negotiating, alienating, transferring, assigning of encumbering the properties and the Assets of the Respondent No. 1 Company or creating any third party right, title or interest in respect of parting with the possession of the said properties in any manner whatsoever;
- (h) to restrain the Respondents, Creating any liability in the Respondent No. 1 Company, giving loans from the funds of the Respondent No. 1 Company and/or accepting any loan on behalf of the Respondent No. 1 Company;
- (i) to restrain the Respondents, Utilizing the funds of the Respondent No. 1 Company for the purpose of the instant litigation in any manner whatsoever;
- (j) to Pass an Order not to hold liable the Applicants for any illegal and fraud done by the Respondents No. 2, 5 & 6;
- (k) In alternative, that this Hon'ble Tribunal be pleased to pass an Order for winding up of the Company;
- (l) Pass such other and/or further order(s) as this Hon'ble Tribunal may deem fit and proper in the facts and circumstances of the present case.

*Nimish Aggarwal*      *For Urish Aggarwal*  
*Nimish Aggarwal*



Certificate of Formation  
Government of Ras Al Khaimah

شهادة تأسيس  
حكومة رأس الخيمة

Registration No. RAKFTZA-FZE- 4019338 رقم التسجيل:  
Registration Date: 05 March 2017 تاريخ التسجيل:

The Ras Al Khaimah Free Trade Zone Authority hereby certifies that implementing regulations regarding the formation of a Free Zone Establishment and all legal requirements concerning the incorporation have been satisfied and:

تشهد هيئة المنطقة الحرة برأس الخيمة بأن كافة الإجراءات و متطلبات قانون تأسيس مؤسسة منطقة حرة قد إستوفيت وعليه فإن:

## POTOMAC AVIATION TECHNOLOGY FZE

## بوتوماك أفياشين تكنولوجي ح م م

Is incorporated in the Ras Al Khaimah Free Trade Zone as a Free Zone Establishment with limited liability

قد تأسست في المنطقة الحرة برأس الخيمة كمؤسسة منطقة حرة ذات مسؤولية محدودة

The said Establishment is incorporated under our seal, at Ras Al Khaimah Free Trade Zone, Ras Al Khaimah, United Arab Emirates

المؤسسة المذكورة تأسست بمعرفتنا وتحت ختمنا بالمنطقة الحرة برأس الخيمة، رأس الخيمة، الإمارات العربية المتحدة

Licensing Department  
Ras Al Khaimah Free Trade Zone Authority



قسم التراخيص  
هيئة المنطقة الحرة برأس الخيمة



Commercial Licence  
Government of Ras Al Khaimah

رخصة تجارية  
حكومة رأس الخيمة

LICENSE NO	5014109	5014109	رقم الرخصة
LICENSEE	Swapnil Baban Chavan	سوابنيل بابان تشافان	صاحب الرخصة
OPERATING NAME	POTOMAC AVIATION TECHNOLOGY FZE	بوتوماك أفياشين تكنولوجي م م ح	الإسم التجاري
ADDRESS	P.O.Box 39959 Ras Al Khaimah United Arab Emirates	ص ب 39959 رأس الخيمة الإمارات العربية المتحدة	العنوان
ACTIVITY	Trading in Aircraft Spare Parts, Components, Airport Equipment, Handling, Loading & Lifting Equipment	التجارة بقطع غيار الطائرات ومكوناتها، ومعدات المطارات، ومعدات وآلات التحميل والرفع	النشاط
MANAGER	Swapnil Baban Chavan	سوابنيل بابان تشافان	المدير
ISSUE DATE	05 March 2017	٠٥ مارس ٢٠١٧	تاريخ الاصدار
VALID DATE	04 March 2018	٠٤ مارس ٢٠١٨	تاريخ الانتهاء
REMARKS			ملاحظات





# MEMORANDUM OF ASSOCIATION OF A SINGLE SHAREHOLDER FREE ZONE LIMITED LIABILITY ESTABLISHMENT

This Memorandum of Association ("MOA") is entered on 27/02/2017

by and between:

Swapnil Baban Chavan

Nationality: Indian

Holder of Passport No.: N9983955

issued in Mumbai

on 02/06/2016

Address: 8601 Park Lane Laneshaw #313, Dallas TX 75231, USA

Hereinafter referred to as "Owner".

Whereas the Owner, enjoying full legal capacity, and duly delegated and empowered by proper corporate documentation to contract, have agreed hereto to form and register a Free Zone Single Shareholder Limited Liability Establishment (the "Company") with Ras Al Khaimah Free Trade Zone Authority ("RAK FTZ") - compliant with RAK FTZ Rules and Regulations and other governing documents, as may be from time to time amended, and other applicable federal laws in the UAE and local laws in Ras Al Khaimah, upon the terms and subject to the conditions of this MOA:

## Article (1): Recitals

The above recitals shall constitute an integral part of this MOA.

## Article (2): Name of the Company

The name of the Company shall be: POTOMAC AVIATION TECHNOLOGY (hereafter referred to as "the Company").

Free Zone Establishment

## Article (3): Head Office

The Head Office of the Company shall be located in one of the RAK FTZ Parks.

## Article (4): Objects of the Company

To carry on all such business as RAK FTZ may permit under the terms of the licence to be issued to it by RAK FTZ and any other business necessary to the objects of the Company, in accordance with applicable laws and regulations in the UAE and RAK FTZ (the "Licence"). For the purpose of this Clause, the Licence shall be an integral part of the MOA.

The Company shall not carry on the business of insurance, banking or investment of funds.

## Article (5): Duration of the Company

The duration of the Company shall be for an unlimited period, starting from the date of registration. Such duration may be shortened by an Owner's Declaration.

## Article (6): Capital of the Company

The capital of the Company shall be AED 1000 ( One Thousand dirhams only) divided into 01 shares of the value of AED one thousand each (the "Share"), contributed in cash and owned in full by the Owner.

The Owner declares having deposited the cash shares nominal value at the Company's bank account.

## Article (7): Liability of the Owner

- A. The liability of the Owner shall be limited to his Shares in the capital of the Company.
- B. The Company shall state the term "Free Zone Company" in all its deeds, announcements, publications, papers, accounts and letterheads, and other issued documents.

*Swapnil Chavan*



**Article (8): Management of the Company**

The Owner agreed to appoint Swapnil Baban Chavan Indian national as a General Manager (the "GM") and delegates the GM with the daily operations of the Company, its representation and signing on its behalf before RAK FTZ. The GM will be responsible in renewing the Company's licence, signing the lease agreement and its amendments, appointing and dismissing employees, and representing the Company before all other third parties within such standard powers of a GM.

The Owner may grant additional powers to the GM through a separate power of attorney.

The GM may be dismissed, and its powers may be amended any time by the Owner.

The GM shall prepare the annual balance sheet, the statements of profits and losses, and the annual report on the activities of the Company and its financial status, and his proposals for distribution of the dividends and losses. The GM shall submit these reports within three months from the end of the fiscal year. The balance sheet and its enclosures shall be submitted to the Owner for approval and thereafter file the same with RAK FTZ in accordance with the applicable rules and regulations.

**Article (9): Financial Year**

The financial year of the Company shall commence from 1 January and end 31 December of each year excluding the first fiscal year, which shall commence on the date of the registration of the Company with RAK FTZ and may extend for more than 12 months but no more than 18 and no less than six months.

**Article (10): Auditors**

The Owner shall appoint qualified accountants who are licenced to practice in the UAE or RAK FTZ as auditors. The Auditors shall comply with the applicable rules and regulations.

**Article (11): Amendments**

This MOA shall not be amended except with the consent of the Owner.

**Article (12): Dissolution of the Company**

The Company shall be dissolved upon any of the following events:

1. Expiry of the duration of the Company
2. Owner agreeing to dissolve the Company
3. Upon a court decision to dissolve the Company

**Article (13): Liquidation of the Company**

The Owner shall appoint one or more liquidators who shall adhere to the provisions set out in the UAE Federal Commercial Companies Law as amended unless the Owner agrees otherwise at the time of dissolving the company.

If the liquidation of the Company is pursuant to a judgment passed by the court, then the court shall specify the manner of liquidation and shall appoint the liquidator. The powers of the GM shall cease upon appointment of a liquidator.

**Article (14): Applicable Law**

Matters, which are not provided for herein, shall be subject to the provisions of the rules and regulations in force in RAK FTZ.

**Article (15): Copies of this MOA**

This MOA has been produced with two original copies. The Company shall hold one original and the other original shall be kept with RAK FTZ.

**Article (16): Miscellaneous**

The Company is not allowed to perform its business until it is registered with and licenced by RAK FTZ. Individuals shall be jointly liable for all acts or transactions performed on behalf of the Company by them prior to its registration.

In witness whereof the Owner hereto executed this memorandum on the day and year first hereinabove written.

Signed by: Name: Swapnil Baban Chavan

Capacity: Owner

Signature:

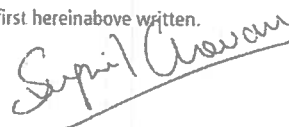

(For official use only) Record No.: NMOA/17/545

Registration Date: 05/03/2017



Tuesday, March 07, 2017

## شهادة لمن يهمله الأمر

تشهد مجموعة بريد الإمارات في مكتب بريد المنطقة الحرة - رأس الخيمة أن :

صندوق البريد رقم: 39959

مؤجر لدينا : POTOMAC AVIATION TECHNOLOGY FZE

اعتباراً من 2017/03/07 وينتهي بتاريخ 31/12/2017

وهذه شهادة منا بذلك دون تحمل المؤسسة ادنى مسؤولية فيما يتعلق بحقوق الغير .

وتقبلوا منا فائق الاحترام والتقدير..

اعتماد

الاسم : محمد الخراز

التوقيع :-

مجموعة بريد الإمارات  
EMIRATES POST

07 MAR 2017

مكتب بريد المنطقة الحرة - رأس الخيمة  
FREE ZONE RAK-Post Office  
S.NO. - 1

هاتف: 072280411

فاكس: 072280477

بريد إلكتروني: rak.freezone@emiratespost.ae

United Arab Emirates  
MINISTRY OF INTERIOR

General Directorate of Residency & Foreigners Affairs



دولة الإمارات العربية المتحدة  
وزارة الداخلية

الإدارة العامة للإقامة وخوون الأجانب

eVisa - إن دخول الكتروني



14101325/26



0702018717686629

سياحية/سفرة قصيرة  
Tourist/Single-Short

ENTRY PERMIT NO : 87686629 / 2017 / 201 : إن دخول رقم  
Date & Place Of Issue : 12-FEB-2017 DUBAI : تاريخ ومحل الاصدار : دبي 2017/02/12  
Valid Until : 12-APR-2017 : تاريخ صلاحية الدخول : 2017/04/12  
U.I.D. No : 184260705 : الرقم الموحد  
Allowed to Enter U.A.E to : : اجيز بدخول دولة الامارات العربية المتحدة الى :  
Full Name : Mr.SWAPNIL BABAN CHAVAN BARAN : الاسم الكامل : Mr.SWAPNIL BABAN CHAVAN  
EKNATH CHAVAN S/O BABAN EKNATH : BABAN EKNATH CHAVAN S/O  
CHAVAN : BABAN EKNATH CHAVAN  
Nationality : INDIAN : الجنسية : الهند  
Place of Birth : MUMBAI MAHARASHTRA : محل الميلاد :  
Date of Birth : 14-NOV-1988 : تاريخ الميلاد : 1988 / 11 / 14  
Passport No : NORMAL / N9983955 : رقم الجواز : عادي / N9983955  
Profession : SALES OFFICER : المهنة : ضابط مبيعات  
Accompanied by : المرافقون :  
Wife : None : الزوجة :  
Children : None : الأبناء :

Sponsor الكفيل  
Name : DNATA - MARHABA SERVICES : الاسم :  
Address : TEL:042186418, P.O BOX :522, 2/2/73245 : العنوان :

Note : ENJOY YOUR VISIT & LEAVE BEFORE YOUR VISA  
EXPIRES SO WE CAN WELCOME YOU AGAIN.

تتنبه : نتمنى بوقت نك والفرح قبل انتهاء ايتم الترحيب بك مرة أخرى



Director of Residency & Foreigners Affairs

استوفيت الرسوم

مدير الإدارة العامة للإقامة وشؤون الاجانب

لتواصل مع الأمانة يرجى الاتصال برقم  
8005111 / 04-3139999  
For any inquiry please call AMER SERVICE  
tel : 04-3139999 / 8005111



في أمان قريبتك هو أمان جوارك  
A safer neighbourhood is a safer home.  
Toll free 8004288 www.ameen.ae



Name - **Swapnil Baban Chavan**  
 DOB - 14-11-1988  
 PAN - AJDPC8248C  
 Address - Chavan House, Marol Maroshi Road, Opp-ICICI Bank,  
 Marol Mumbai, Mumbai Suburban, Maharashtra – 400059  
 Contact Number - +91 8591077096  
 Bank Account details - A/c No. – 104401531869  
 IFSC - ICIC0001044  
 Bank – ICICI Bank, Marol Branch, Mumbai

Bank Account details - A/c No. – 921010008877100  
 IFSC - UTIB0000328  
 Bank – Axis Bank, Andheri Kurla Road, Andheri (East)

Name - **Sneha Baban Chavan**  
 DOB - 06-01-1970  
 PAN - AJCPC3117B  
 Address - Chavan House, Marol Maroshi Road, Opp-ICICI Bank,  
 Marol Mumbai, Mumbai Suburban, Maharashtra – 400059  
 Contact Number - +91 8591077096  
 Bank Account details - A/c No. – 013200128873557  
 IFSC - SRCB0000013  
 Bank – Saraswat Bank, Marol Branch, Mumbai

**Mr Swapnil Baban Chavan**

Date	Particulars	Amount Paid
15-11-2019	EFT TO UTR#CITIN19062861722-SWAPNIL BABAN CHAVAN -OT - XXXXXXXXX1869 -ICICI BANK LIMITED -MUMBAI -MUMBAI - MAROL -REF NO#090011829920107	2,00,000
18-03-2021	RTGS/DCBL202103185000003025/UTIB/Swapnil Baban C	5,00,000
18-03-2021	RTGS/DCBL202103185000009585/UTIB/SWAPNIL BABAN C	10,00,000
18-03-2021	NEFT/000001077014/UTIB/Swapnil Baban C	18,64,000
07-09-2021	MC ISSUED - ANDHERI MUMB - 008612164607 - - SWAPNIL BABAN CHAVAN	8,91,000
24-12-2021	IMPS:PAY:135817529323/104401531869/ICICI BANK	50,000.00
25-12-2021	NEFT/000006063130/ICIC/Swapnil Baban C	47,400.00
<b>TOTAL</b>		<b>45,52,400</b>

**Mrs Sneha Baban Chavan**

Date	Particulars	Amount Paid
04-07-2019	RTGS/DCBL201907045000004221/SRCB/CHAVAN SNEHA BA	3,00,000.00
31-08-2019	CMS:NEFT:SNEHA BABAN CHAVAN:013200128873557	2,00,000.00
15-11-2019	RTGS/DCBL201911155000001910/SRCB/SNEHA BABAN CHA	2,50,000.00
12-03-2021	NEFT/000000949766/SRCB/SNEHA BABAN CHA	5,00,000.00
13-03-2021	NEFT/000000976435/SRCB/SNEHA BABAN CHA	8,32,000.00
16-03-2021	RTGS/DCBL202103165000002156/SRCB/SNEHA BABAN CHA	17,82,000.00
07-09-2021	RTGS DR-SRCB0000013-SNEHA BABAN CHAVAN-ANDHERI MUMB- HDFCR52021090763499932	8,91,000
<b>TOTAL</b>		<b>47,55,000</b>

**93,07,400**



Rinku Dudani  
typing...



After this 11:39 AM

➔ Forwarded

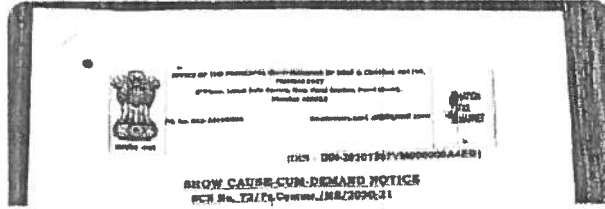

PDF Supreme Transport GST No...

4 pages • 1.1 MB • PDF 11:39 AM

➔ Forwarded



PDF Central Exise Claim.pdf

7 pages • 453 kB • PDF 11:39 AM

And this is not it 11:40 AM

From random numbers 11:40 AM

I have recieved shit 11:40 AM

And it must have gone to all ur contacts 11:40 AM

Too 11:40 AM

So ppl know 11:40 AM

What shit is happening 11:40 AM



5:09



< 359



S Chavan

last seen today at 4:27 AM



I still stick to my word

8:02 PM ✓✓

U betrayed me twice in the past

8:02 PM

Twice ?

8:02 PM ✓✓

U gave statement against me

8:02 PM

Yes

8:02 PM

I told u I wil take it back !

8:02 PM ✓✓

I never did

8:02 PM ✓✓

Damage is done rinku

8:02 PM

I m telling u again and again

8:02 PM ✓✓

Am not even angry at u

8:03 PM

Cause it was a lie

8:03 PM

And it doesn't matter anymore

8:03 PM

M not angry at anyone either m just not wanting to see him in this



This message was deleted

3:36 AM

Bolna bro 9:51 AM ✓✓

Met swapnil yesterday... He was talking about some meeting with Deputy commissioner Income tax dept ... He did not give me more details... He just said ki lagne waali hai aur types... He also told me that in his FIR you had given my name also ... Requesting you again not to involve my name in all of this... Have asked him to do the same... Thanks 🙏

10:22 AM

Atul Pandey

Met swapnil yesterday... He was talking about some meeting with Deputy commissioner Income tax d...

Bro

Show me your name bro

10:23 AM ✓✓

Usne mujhe nahi bheja hai FIR

10:23 AM

I don't know what is truth or not... I am just telling you what he told me

10:24 AM

# ← FIRE HAWK



HOME

VIDEOS

PLAYLISTS

CHANNELS

ABOUT



## FIRE HAWK

SUBSCRIBE

No subscribers • No videos

More about this channel >

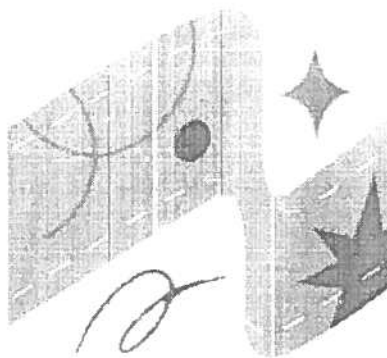

This channel doesn't have any content



Home



Shorts



Subscriptions



Library



### More info

 [http://www.youtube.com/channel/UC5n\\_-Ur5rRtOWiKqIVIJUwQ](http://www.youtube.com/channel/UC5n_-Ur5rRtOWiKqIVIJUwQ)

 Joined Jun 27, 2022



Home



Shorts



Subscriptions



Library





# ← Notifications



All

Mentions

## Important

- 
 FIRE HAWK commented: "Mr Ammeet Agarwal of Supreme Aviation Inc is running a scam by promising students for flight training as pilots and collecting hefty fees from the...  
6 hours ago
- 
 FIRE HAWK commented: "Mr Ammeet Agarwal of Supreme Aviation Inc is running a scam by promising students for flight training as pilots and collecting hefty fees from the...  
6 hours ago



Home



Shorts



Subscriptions



Library



# ← Comments



Comments on "Ammeet K Agarwal on 'FDI in INDIA' at 8th INDO-US SUMMIT 2012"



Remember to keep comments respectful and to follow our Community Guidelines

### Highlighted comment



FIRE HAWK · 6 hours ago

Mr Ammeet Agarwal of Supreme Aviation Inc is running a scam by promising students for flight training as pilots and collecting hefty fees from them in advance and absconding. This company is already FAA de-certified in USA during year 2017 and still claims to be certified under FAA. It has no flights or offices in Texas USA and is operating this scam from Mumbai City in India. The promoter Ammeet Agarwal is declared insolvent (for his Company Sangeeta Aviation Services in India and has more than 65 cases of cheating and forgery against him in courts in India. He is also an accused in a rape case in India of which trial is pending in a court in Mumbai, India. He was behind the bars for cheating Ministry of External Affairs and DR Congo Government.





H.E. Capt Ammeet Agar...

Active now



Can you transfer now

Don't worry I will return in the morning

Tell me



What happen

Give me your number

You replied

Don't worry I will return in the morning

Not a problem

9178162321 phone pay Google pay



Amount send kar kar screenshot dal

This is your number?

Should I gpay you?



Message...



9:01



H.E. Capt Ammeet Agar...

Active now



supremeairline\_ · Instagram

2 followers · 1 post

You follow each other on Instagram

New Instagram account

View Profile

Today 9:00 pm



Hello

Hey



Give me one help

Yup tell me



Do you have phone pay Google pay

Ya



Actually my account limit complete its so urgent 10000



Message...





H.E. Capt Ammeet Agar...

Active now



What happen

Tell me

What happen

Tell me



Please send amount

I was thinking Mumbai ke police mai complaint karu ya Orissa ke

Do you even know Ammeet hai kaun?

Don't mess with his name

He has my number if she needs anything he will call me

Seen just now

You better delete this account right away

And thoda hardwork kar and paise kama



Message...





Sakshee Gu...

12:02

name and asking for money. Warn your friends please

10:34

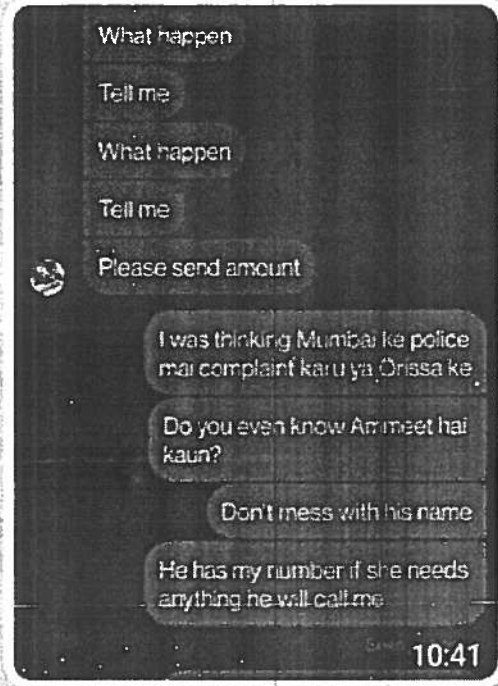

Wow 11:50 ✓✓

Omg 11:50 ✓✓

Shit 11:50 ✓✓

Did you report the account?

11:51 ✓✓

He blocked me 🤔

11:59

Username?

12:01 ✓✓

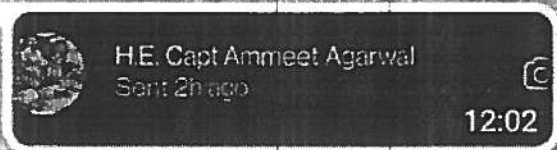



H.E. Capt Ammeet...

Active now



9178162321 phone pay

Google pay



You have much available balance



Tell me

its zero

5000

Sent me

Please send me

9178162321 phone pay  
Google pay

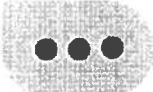

Message...





H.E. Capt Ammeet...

Active now



Actually my account limit complete its so urgent 20000

Can you transfer now

Don't worry I will return in the morning



Tell me

sorry sir right now i dnt have... its month ending thats why...



9178162321 phone pay  
Google pay



You have much available balance



Your available balance how much



Message...





H.E. Capt Ammeet...  
Active now



Today 20:51



Hello

hiii sir...how are you...??

Fine



Give me one help

yes sir...



Do you have phone pay  
Google pay

yes sir

Actually my account limit  
complete its so urgent  
20000

Can you transfer now

Don't worry I will return in



Message...



← supremeairline\_ 🔔 ⋮



1 Posts   2 Followers   39 Following

H.E. Capt Ammeet Agarwal  
Pilot n da Prince  
Pilot  
Aviator  
Businessman ... more

Following ▾

Message





bring\_it\_onmore\_



0  
Posts

0  
Followers

1  
Following

Donthurtheonewho

Follow



This Account is Private

Follow this account to see their photos and videos.

Suggested for you

See all



eversmith\_furnit...  
EVERSMITH

Follow



coco\_shihtzubaby  
CoCo

Follow



---

**From:** Supreme Aviation Inc ^ Ammeet K Agarwal <ammeet@supremeaviation.com>  
**Sent:** Tuesday, December 06, 2022 2:34 PM  
**To:** varun@supremeaviation.com  
**Subject:** FW: Resume  
**Attachments:** mukesh Resume.docx

**Importance:** High

**From:** kamlesh bairwa [mailto:kamikumar082@gmail.com]  
**Sent:** 09 December 2016 10:57  
**To:** akkash@supremeaviation.com  
**Subject:** Resume

Dear sir, It's a humble request to appoint my cousin younger brother if any vacancy in our company. I am feeling very alone here. I am sure he will give his best here. Thank you

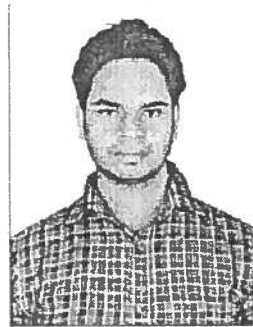

## Resume

**Mukesh Bairwa**

93 D, Narayan vihar 1<sup>st</sup>  
jagannathpura sanganer  
Distt. Jaipur  
Raj. 302029

Email: mukeshbairwa448@gmail.com  
Mobile: 91-9680810176, 8432041877

<b>CAREER OBJECTIVE</b>	To work for an organization which provides me the opportunity to improve my skills and knowledge to grow along with the organization objective?
<b>EDUCATIONAL QUALIFICATION</b>	Class X in 2009 from Rajasthan Board, Ajmer Class XII in 2011 from Rajasthan Board, Ajmer B.com in 2016 from Rajasthan university commerce collage
<b>WORK EXPERIENCE</b>	<ol style="list-style-type: none"><li>1. 18 month in <b>Census Office</b>, Jhalana, Jaipur as a Data Entry Operator</li><li>2. One year in New bit , jaipur as a <b>Aadhar technician</b> .</li><li>3. One year in bikaji , jaipur airport as a cashier .</li><li>4. Working at the Phed office , jaipur since feb. 2016 as a billing operator.</li></ol>

<b>COMPUTER PROFICIENCY</b>	Working knowledge regarding application package MS Office, Internet etc. Operating System Window XP, Windows - Vista TALLY Accounting work
<b>PERSONALS DETAILS</b>	<ul style="list-style-type: none"> <li>• Date of Birth: 20<sup>th</sup> Aug, 1991</li> <li>• Father's name: Shri satya Narayan bairwa</li> <li>• Father's Occupation: Farmer</li> <li>• Sex : Male</li> <li>• Marital Status : Unmarried</li> <li>• Nationality : Indian</li> <li>Reference Address: 93 D Narayan vihar jagannathpura Sanganer Distt. Jaipur  Raj. 302029</li> </ul>
<b>Language Knowledge</b>  <b>Hobby</b>	<ul style="list-style-type: none"> <li>• Hindi</li> <li>• English</li>   <li>• Reading</li> <li>• Listen Song</li> <li>• Travelling</li> <li>• Cricket</li> </ul>

Date:

Place:

(Mukesh bairwa)



## DETAILED STATEMENT

Search

Account Number 104401531869(INR) - SWAPNIL B CHAVAN  
Transaction Date from 01/04/2019 to 31/03/2020  
Transaction Period Today

Advanced Search

Amount from NA to NA  
Cheque number from NA to NA  
Transaction remarks NA  
Transaction type All

Transactions List - SWAPNIL B CHAVAN - 104401531869

S No.	Value Date	Transaction Date	Cheque Number	Transaction Remarks	Withdrawal Amount (INR)	Deposit Amount (INR)	Balance (INR)
1	15/04/2019	15/04/2019	-	MABchgs-Mar19+GST	2.98	0.0	0.02
2	10/05/2019	10/05/2019	-	MABchgs-Apr19+GST	0.02	0.0	0.0
3	27/09/2019	27/09/2019	-	ACH/AJDPC8248C-AY2019-20/CE19103629129	0.0	9270.0	9270.0
4	29/09/2019	30/09/2019	-	104401531869:Int.Pd:29-06-2019 to 29-09-2019	0.0	3.0	9273.0
5	30/09/2019	30/09/2019	-	Rubyx Drcard JoinFee+GST	1178.82	0.0	8094.18
6	06/10/2019	07/10/2019	-	JIN/Debit/Amazon /201910062057/927901009854/	458.0	0.0	7636.18
7	06/10/2019	07/10/2019	-	JIN/Amazon /201910062112/100615114943/	298.0	0.0	7338.18
8	07/10/2019	07/10/2019	-	ATM/S1CPN412/CASH WDL/07-10-19	1000.0	0.0	6338.18
9	07/10/2019	07/10/2019	-	MPS/BAJRANG AUT/201910070148/304105/MUMBAI	500.0	0.0	5838.18
10	09/10/2019	09/10/2019	-	MIN/SWIGGY /201910090207/182079/	255.0	0.0	5583.18
11	11/10/2019	11/10/2019	-	MCD REF BAJRANG AUTO MA DT /191007	0.0	3.75	5586.93
12	11/10/2019	11/10/2019	-	ATM/S1CNR795/CASH WDL/11-10-19	500.0	0.0	5086.93
13	13/10/2019	14/10/2019	-	MPS/NITYA WINE /201910132209/000000003615/MUMBAI	545.0	0.0	4541.93
14	14/10/2019	14/10/2019	-	NFS/S1ACM24/CASH WDL/14-10-19	500.0	0.0	4041.93
15	15/10/2019	15/10/2019	-	ATM/S1CNR795/CASH WDL/15-10-19	500.0	0.0	3541.93
16	16/10/2019	16/10/2019	-	MIN/PTM PAYTM /201910160425/329877/	208.0	0.0	3333.93
17	18/10/2019	18/10/2019	-	MABchgs-Sep19+GST	637.37	0.0	2696.56
18	19/10/2019	19/10/2019	-	NFS/DPRH4013/CASH WDL/19-10-19	500.0	0.0	2196.56
19	19/10/2019	19/10/2019	-	JIN/PAYTM /201910190224/101820283985/	202.0	0.0	1994.56
20	22/10/2019	22/10/2019	-	NFS/SB001301/CASH WDL/22-10-19	500.0	0.0	1494.56
21	24/10/2019	24/10/2019	-	MPS/TANVI MOBIL/201910242310/233932/MUMBAI	100.0	0.0	1394.56
22	27/10/2019	28/10/2019	-	MPS/VISHAL WINE/201910272205/525972/MUMBAI	350.0	0.0	1044.56
23	01/11/2019	01/11/2019	-	NFS/SB001301/CASH WDL/01-11-19	500.0	0.0	544.56
24	12/11/2019	12/11/2019	-	MPS/BAJRANG AUT/201911121847/990377/MUMBAI	500.0	0.0	44.56
25	14/11/2019	14/11/2019	-	MABchgs-Oct19+GST	44.54	0.0	0.02

26	15/11/2019	15/11/2019	NEFT-CITIN19062861722-SANGEETA AVIATION SERVICES PVT LTD- ICIC0001041-0060246114	0.0	200000.0	200000.02
27	15/11/2019	15/11/2019	CAM/10441HRY/CASH WDL/15-11-19	80000.0	0.0	120000.02
28	15/11/2019	15/11/2019	CAM/10441HRY/CASH WDL/15-11-19	70000.0	0.0	50000.02
29	16/11/2019	16/11/2019	MCD REF BAJRANG AUTO MA DT 191112	0.0	3.75	50003.77
30	21/11/2019	21/11/2019	CAM/10861HRY/CASH WDL/21-11-19	50000.0	0.0	3.77
31	21/11/2019	21/11/2019	CAM/10861HRY/CASH WDL RVSL/21-11-19	0.0	50000.0	50003.77
32	21/11/2019	21/11/2019	ATM/S1CPN412/CASH WDL/21-11-19	20000.0	0.0	30003.77
33	21/11/2019	21/11/2019	ATM/S1CPN412/CASH WDL/21-11-19	20000.0	0.0	10003.77
34	21/11/2019	21/11/2019	ATM/S1CWK286/CASH WDL/21-11-19/Fee Rs20.00 GST Rs3	8023.6	0.0	1980.17
35	21/11/2019	21/11/2019	ATM/S1CWK286/CASH WDL/21-11-19/Fee Rs20.00 GST Rs3	1823.6	0.0	156.57
36	20/12/2019	20/12/2019	SMSChgsOct19-Dec19+GST	17.7	0.0	138.87
37	30/12/2019	31/12/2019	104401531869:Int.Pd:30-09-2019 to 30-12-2019	0.0	42.0	180.87
38	24/02/2020	24/02/2020	MABchgs-Dec19+GST	180.86	0.0	0.01
39	24/02/2020	24/02/2020	MABchgs-Jan20+GST	0.01	0.0	0.0
40	29/03/2020	30/03/2020	104401531869:Int.Pd:31-12-2019 to 29-03-2020	0.0	1.0	1.0

Legends Used in Account Statement

1. INFT - Internal Fund Transfer (Within ICICI Bank)
2. BPAY - Bill payment
3. BBPS - Bharat Bill Payment Service
4. NEFT - National Electronics Funds Transfer System (Other Bank Fund transfer)
5. RCHG - Recharge
6. ONL - Online Shopping transaction (Payment done on third party website)
7. SMO - Smart Money order
8. DTAX - Direct Tax
9. IDTX - Indirect Tax
10. PAVC - Pay any Visa credit card
11. PAC - Personal Accident cover
12. LNPY - Linked loan payment
13. CCWD - Cardless Cash Withdrawal
14. PAYC - Pay to Contact
15. IMPS - Immediate Payment Service
16. VAT / MAT / NFS - Cash withdrawal at other bank ATM
17. INF - Internet fund transfer in linked accounts
18. EBA - Transaction on ICICI Direct
19. BIL - Internet Bill payment or funds transfer to Third party
20. VPS / IPS - Debit card transaction
21. TOP - Mobile recharge
22. BCTT - Banking Cash Transaction Tax
23. UCCBRN CMS - Upcountry cheque collection
24. LCCBRN CMS - Local cheque collection
25. N chg - NEFT Charges
26. MMT - Mobile Money Transfer (Insta FT - IMPS)
27. T Chg - Travel Charges



## DETAILED STATEMENT

### Search

Account Number 104401531869(INR) - SWAPNIL B CHAVAN  
Transaction Date from 01/04/2021 to 22/01/2022  
Transaction Period Today  
Advanced Search  
Amount from NA to NA  
Cheque number from NA to NA  
Transaction remarks NA  
Transaction type All  
Transactions List - SWAPNIL B CHAVAN - 104401531869

S No.	Value Date	Transaction Date	Cheque Number	Transaction Remarks	Withdrawal Amount (INR)	Deposit Amount (INR)	Balance (INR)
1	03/04/2021	03/04/2021	-	ATM/S1CNR795/CASH WDL/03-04-21	8500.0	0.0	161.18
2	20/05/2021	20/05/2021	-	MABchgs-Mar21+GST	161.17	0.0	0.01
3	21/05/2021	21/05/2021	-	MABchgs-Apr21+GST	0.01	0.0	0.0
4	29/06/2021	30/06/2021	-	104401531869: Int.Pd:30-03-2021 to 29-06-2021	0.0	3.0	3.0
5	09/07/2021	09/07/2021	-	MABchgs-Jun21+GST	2.98	0.0	0.02
6	09/08/2021	09/08/2021	-	SMSChgsJul21-Sep21+GST	0.02	0.0	0.0
7	23/09/2021	22/09/2021	-	MMT/IMPS/126518935231/SUPREME/Punjab National	0.0	100.0	100.0
8	22/09/2021	22/09/2021	-	MMT/IMPS/126519392052/Ammeet Sir/AMMEET KAM/DCBL00	55.9	0.0	44.1
9	24/09/2021	24/09/2021	-	CLG/PO/154474/HDF/07.09.2021	0.0	891000.0	891044.1
10	24/09/2021	24/09/2021	-	BIL/NEFT/000214921491/AMMEET SIR/AMMEET KAM/DCBL00	891000.0	0.0	44.1
11	12/10/2021	12/10/2021	-	MABchgs-Sep21+GST	44.09	0.0	0.01
12	28/10/2021	28/10/2021	-	DCardfee0528SEP21-AUG22+GST	0.01	0.0	0.0
13	24/12/2021	24/12/2021	-	MMT/IMPS/135817529323/Swapnil Sir/AMMEET KAM/DCB B	0.0	50000.0	50000.0
14	25/12/2021	27/12/2021	-	NEFT-000006063130-AMMEET KAMAL AGARWAL-JURGENT/00	0.0	47400.0	97400.0
15	26/12/2021	27/12/2021	-	DCardfee0528SEP21-AUG22+GST	883.81	0.0	96516.19
16	28/12/2021	28/12/2021	-	MMT/IMPS/136220894304/MILLION AIR/MILLION AI/UBINO	96505.9	0.0	10.29
17	30/12/2021	31/12/2021	-	104401531869: Int.Pd:30-09-2021 to 30-12-2021	0.0	28.0	38.29
18	19/01/2022	19/01/2022	-	INF/INFT/026063433431/PREPROD/INSTANTPAY INDI	0.0	100.0	138.29

Legends Used in Account Statement

1. INFT - Internal Fund Transfer (Within ICICI Bank)
2. BPAY - Bill payment
3. BBPS - Bharat Bill Payment Service
4. NEFT - National Electronics Funds Transfer System (Other Bank Fund transfer)
5. RCHG - Recharge
6. ONL - Online Shopping transaction (Payment done on third party website)
7. SMO - Smart Money order
8. DTAX - Direct Tax
9. IDTX - Indirect Tax
10. PAVC - Pay any Visa credit card
11. PAC - Personal Accident cover
12. LNPY - Linked loan payment
13. CCWD - Cardless Cash Withdrawal
14. PAYC - Pay to Contact
15. IMPS - Immediate Payment Service
16. VAT / MAT / NFS - Cash withdrawal at other bank ATM
17. INF - Internet fund transfer in linked accounts
18. EBA - Transaction on ICICI Direct
19. BIL - Internet Bill payment or funds transfer to Third party
20. VPS / IPS - Debit card transaction
21. TOP - Mobile recharge
22. BCTT - Banking Cash Transaction Tax
23. UCCBRN CMS - Upcountry cheque collection
24. LCCBRN CMS - Local cheque collection
25. N chg - NEFT Charges
26. MMT - Mobile Money Transfer (Insta FT - IMPS)
27. T Chg - Travel Charges



## DETAILED STATEMENT

### Search

Account Number 104401531869(INR) - SWAPNIL B CHAVAN  
Transaction Date from 01/04/2020 to 31/03/2021  
Transaction Period Today  
Advanced Search  
Amount from NA to NA  
Cheque number from NA to NA  
Transaction remarks NA  
Transaction type All  
Transactions List - SWAPNIL B CHAVAN - 104401531869

S No.	Value Date	Transaction Date	Cheque Number	Transaction Remarks	Withdrawal Amount (INR)	Deposit Amount (INR)	Balance (INR)
1	08/06/2020	08/06/2020	-	SMSChgsApr20-Jun20+GST	0.99	0.0	0.01
2	14/08/2020	14/08/2020	-	MABchgs-Jul20+GST	0.01	0.0	0.0
3	23/03/2021	23/03/2021	-	ACH/AJDPC8248C-AY2020-21/CE21145308655	0.0	9540.0	9540.0
4	23/03/2021	23/03/2021	-	DCardfee0528SEP20-AUG21+GST	883.82	0.0	8656.18
5	29/03/2021	30/03/2021	-	104401531869:Int.Pd:30-12-2020 to 29-03-2021	0.0	5.0	8661.18

### Legends Used in Account Statement

1. INFT - Internal Fund Transfer (Within ICICI Bank)
2. BPAY - Bill payment
3. BBPS - Bharat Bill Payment Service
4. NEFT - National Electronics Funds Transfer System (Other Bank Fund transfer)
5. RCHG - Recharge
6. ONL - Online Shopping transaction (Payment done on third party website)
7. SMO - Smart Money order
8. DTAX - Direct Tax
9. IDTX - Indirect Tax
10. PAVC - Pay any Visa credit card
11. PAC - Personal Accident cover
12. LNPY - Linked loan payment
13. CCWD - Cardless Cash Withdrawal
14. PAYC - Pay to Contact
15. IMPS - Immediate Payment Service
16. VAT / MAT / NFS - Cash withdrawal at other bank ATM
17. INF - Internet fund transfer in linked accounts
18. EBA - Transaction on ICICI Direct
19. BIL - Internet Bill payment or funds transfer to Third party
20. VPS / IPS - Debit card transaction
21. TOP - Mobile recharge
22. BCTT - Banking Cash Transaction Tax
23. UCCBRN CMS - Upcountry cheque collection
24. LCCBRN CMS - Local cheque collection
25. N chg - NEFT Charges
26. MMT - Mobile Money Transfer (Insta FT - IMPS)
27. T Chg - Travel Charges

NOOR  
TRADEنور  
التجارة

POTOMAC AVIATION TECHNOLOGY FZE  
IND  
400059  
AREA ANDHERI EAST CITY MUMBAI  
BLDG CHAVAN HOUSE ST MAROL MAROSHI ROAD

Customer Number	1095199	رقم العميل
Account Number	02410951990018	رقم الحساب
IBAN	AE950520002410951990018	IBAN
Account Type	CURRENT ACCOUNT	نوع الحساب
Currency	UAE DIRHAM	العملة
Branch Name	NOOR TRADE BRANCH - DMCC	اسم الفرع
Statement Period	05-APR-2017 - 30-APR-2017	تاريخ الكشف
Statement Date	01-MAY-2017	مدة الكشف

Page No.: 1 of 2

**NOW IS GOOD. NOOR GETS IT DONE.**

التاريخ Date	التفاصيل Transaction Details	مدين Debit	دائن Credit	الرصيد Balance
19-APR-2017	Opening Balance			0.00
19-APR-2017	INWARD UAEFTS REMITTANCE REFERENCE 000INCB171090666/000INCB171090666, 72932.15, 72932.15, AED, @1 B/O /917020029284510 SUPREME TRANSPORT ORGANISATION PVT 5/B-34- AKSHAY MITTAL INDUSTRIAL E S TATE M.V. ROAD ANDHERI (EAST MUM TELEGRAPHIC TRANSFER FEE	10.00	72,932.15	72,932.15
19-APR-2017	000INCU171090178/000INCU171090178, 72983.04, 72983.04, AED, @3.655 B/O /10451131002901 SUPREME TRANSPORT ORGANISATION PVT LTD 5B 34 MITTAL INDUSTRIAL ESTATE M V ROAD ANDHERI EAST MUMBAI 400 059		72,983.04	145,905.19
19-APR-2017	INWARD SWIFT REMITTANCE REFERENCE 000INCU171090178/000INCU171090178, 72983.04, 72983.04, AED, @3.655 B/O /10451131002901 SUPREME TRANSPORT ORGANISATION PVT LTD 5B 34 MITTAL INDUSTRIAL ESTATE M V ROAD ANDHERI EAST MUMBAI 400 059			144,905.19
19-APR-2017	CORP ONLINE BANKING REG CHARGES	1,000.00		144,730.19
19-APR-2017	CORP ONLINE BANKING REG CHARGES	175.00		144,555.19
20-APR-2017	MAILING/COURIER & MISCELLANEOUS FEE	175.00		

\* This statement requires no authorised signatures from the bank.  
You must advise us of any discrepancies in this statement within  
15 days from the date of this statement, otherwise it will be  
deemed to be correct and accepted by you.

\* يتطلب هذا البيان أي التوقيعات المعتمدة من البنك. يجب عليك إعلنا  
من أي اختلافات في هذا البيان في غضون 15 يوما من تاريخ هذا البيان خلاف  
ذلك سيعتبر ان تكون صحيحة ومقبولة من قبلك.

Noor Trade is a division of Noor Bank. Noor Bank PJSC is a company  
existing under the laws of the UAE and its successors or assigns.  
The Bank means Noor Bank.

\* نور للتجارة شركة تابعة لنور بنك. نور بنك (ش.م.ع) هو شركة قائمة و تزاو  
عملها وفقاً للقوانين دولة الإمارات العربية المتحدة و خلفاتها و امتيازات لهم.  
و يقصد بالبنك نور بنك

Please visit <http://download.noortrade.com/> to view  
the latest Noor Trade price guide

Noor Bank  
P.O. Box 8822, Dubai, United Arab Emirates T: +971 4 4268888

8006667  
noortrade.com

## Statement of Account

كشف الحساب

NCOR  
TRADEنور  
التجارة

Customer Number	1095199	رقم العميل
Account Number	02410951990018	رقم الحساب

Page No.: 2 of 2

التاريخ Date	التفاصيل Transaction Details	مدين Debit	دائن Credit	الرصيد Balance
23-APR-2017	CHARGES FOR INTERNATIONAL COURIER TELEGRAPHIC TRANSFER 000OGCU171130093/000OGCU171130093, 73820, AED, @3.691 /2754174361 SUPREME AVIATION INC	73,820.00		70,735.19
23-APR-2017	TELEGRAPHIC TRANSFER FEE 000OGCU171130093/000OGCU171130093, 73820, AED, @3.691 /2754174361 SUPREME AVIATION INC	75.00		70,660.19
23-APR-2017	CORRESPONDENT BANK CHARGES 000OGCU171130093/000OGCU171130093, 73820, AED, @3.691 /2754174361 SUPREME AVIATION INC	125.00		70,535.19
25-APR-2017	TELEGRAPHIC TRANSFER 000OGCC171150180/000OGCC171150180, 70000, AED, @1 /AE320400000252088415001 MANYA JEWELLERY LLC	70,000.00		535.19
	<b>Total</b>	<b>145,380.00</b>	<b>145,915.19</b>	

\* This statement requires no authorised signatures from the bank. You must advise us of any discrepancies in this statement within 15 days from the date of this statement, otherwise it will be deemed to be correct and accepted by you.

\* يتطلب هذا البيان أي التوقيعات المعتمدة من البنك، يجب عليك إعلمنا من أي اختلافات في هذا البيان في غضون 15 يوماً من تاريخ هذا البيان، خلاف ذلك سيمتدرك أن تكون صحيحة ومقبولة من قبلنا.

IN THE COURT OF METROPOLITAN MAGISTRATE  
63<sup>rd</sup> COURT, ANDHERI, MUMBAI

CR. No.55/2022  
Sahar Police Station  
U/s.380, 384, 292, 506 of IPC &  
Section-66 of Information Technology Act  
BA No.551/BA/2022

BAIL ORDER

This is an application filed by accused for bail.

2. Perused application, say filed by I.O. and ld. APP
3. I have heard both the sides at length.
4. Ld. Advocate for accused vehemently argued that, he is local and permanent resident of Marol, Andheri, Mumbai. Informant and accused are acquainted with each other. Relevant recovery is already made. Accused will remain present whenever required. He is ready and willing to abide by all terms and conditions of this Court. He will cooperate the police machinery. He will not jump over the bail conditions. Hence, application be allowed.
5. Preliminary investigation is completed. There are no chances of absconding. All offences are triable by this Court. Trial will take its own time. No purpose will be served by further extending the custody of accused. Considering the background of the matter, conditional bail order at this stage would serve the ends of justice. With this, I pass the following order in the interest of justice:

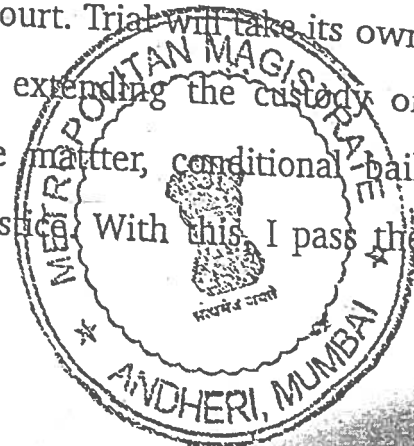

ORDER

1. Application is allowed.
2. Accused is released on S.B. and P.B. of Rs.20,000/- or on cash of like amount provisionally.
3. Accused shall not commit similar or any other offence.
4. Accused to file his ID / permanent residential proofs.
5. Accused shall not make any kind of communication with informant and other prosecution witnesses.
6. Accused to attend the concern police station on every Friday at 11.00 a.m. till 01/04/2022.

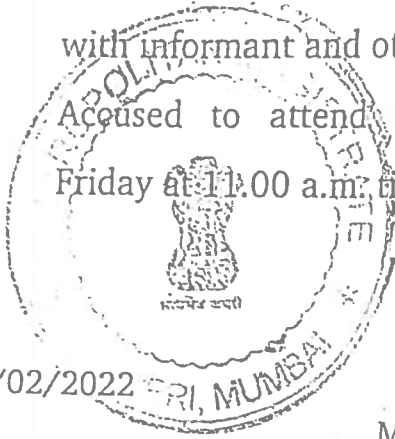

Date : 28/02/2022

(S.A.R. Sayed)

Metropolitan Magistrate,  
63<sup>rd</sup> Court, Andheri, Mumbai.

*SAR* 28/02/22

Paid in A/c-III / Rs. 20000/-

Vide R. No. 146574

Dt 28/02/22

*[Signature]*  
Cashier

Andheri Centre of Court  
Mumbai

Il. The Copy :

*[Signature]*  
Judicial Clerk

Metropolitan Magistrate's  
63<sup>rd</sup> Court Andheri Mumbai



जावक क्रमांक 1230 / 2022  
वरिष्ठ पोलीस निरीक्षक  
सहार पोलीस ठाणे, मुंबई  
दिनांक :- ३८/०२/२०२२

प्रति,

मा. न्यायदंडाधिकारी,  
६३ वे न्यायालय, अंधेरी-पुर्व, मुंबई

विषय :- सहार पोलीस ठाणे, गु.र.क्र ५५/२०२२ कलम ३८०, ३८४,  
२९२, ५०६ (२) भादविसं. सह कलम ६६ (बी) माहिती तंत्रज्ञान  
अधि. मधिल अटक आरोपी यांचा जामीन अर्ज

संदर्भ :- जामीन अर्ज क्रमांक /२०२२

महोदय,

सहार पोलीस ठाणे, मुंबई येथे गु.र.क्र ५५/२०२२ कलम ३८०, ३८४, २९२,  
५०६ (२) भादविसं. सह कलम ६६ (बी) माहिती तंत्रज्ञान अधि. अन्वये गुन्हा  
नोंदविण्यात आला असून सदर गुन्ह्यामध्ये खालील आरोपीतास अटक करण्यात  
आलेले आहे.

अटक आरोपीतांचे नाव/पत्ते :-

स्वप्नील बबन चव्हाण वय ३३ वर्षे रा.ठी. चव्हाण हाउस, मरोळ मरोशी रोड, अंधेरी  
पुर्व, मुंबई

सदर गुन्ह्यातील अटक आरोपीच्या जामीन अर्जास अनुसरून सहार पोलीस  
ठाणेकडून खालील प्रमाणे अहवाल सादर करण्यात येत आहे.

गुन्ह्याची थोडक्यात हकीगत:- नमुद गुन्ह्याचे फिर्यादी श्री. अमीत कमल  
अगरवाल, वय ३३ वर्षे हे व्यवसायीक पायलट असून हवाई क्षेत्रातकाम करणाऱ्या  
वेगवेगळ्या कंपन्यांशी संबंधीत काम करतो. त्यांचे कार्यालय ५ बी, ३२ आणि ३४,  
अक्षय मित्तल इंडस्ट्रीयल इस्टेट, एम व्ही रोड, अंधेरी पुर्व, मुंबई. ५९ या ठिकाणी  
गेल्या १० वर्षांपासून स्वतःच्या मालकीचे आहे.

फिर्यादींची मुख्य कंपनी मे. सुप्रीम ट्रान्सपोर्ट ऑर्गनायझेशन प्रा.ली. आणि मे.  
संगीता एव्हीएशन सर्व्हिस प्रा. ली. या एअरपोर्ट विकासासाठी सरकारी निवीदा व  
कॉन्ट्रॅक्ट घेतात. सदर कंपन्यांतर्फे एअरपोर्ट रनवे लाईट, एअर ट्राफीक अॅडवायसरी  
सिस्टीम, इन्स्ट्रुमेंट लॅन्डिंग सिस्टीम इत्यादी कामे करून दिली जातात.

फिर्यादींचे कंपनीने मागील १० वर्षांमध्ये भारत, थायलंड, यु.ए.ई., यु.एस.ए या  
देशांमध्ये मध्ये हवाई क्षेत्राशी संबंधीत विविध कामे केलेली आहेत. त्या कामांच्या  
अनुषंगाने भारतातील व भारताबाहेरील विमानतळांशी संबंधीत गोपनीय माहिती आम्ही  
गोळा करून ठेवलेली आहे. सदरची माहिती गोपनीय असल्याने तसेच सुरक्षासंबंधीच्या  
दृष्टीकोणातून फिर्यादींचे शिवाय त्यांच्या कंपनीतील इतर कोणीही माहिती देऊ शकत नाही.  
सदर गोपनीय माहिती चोरी होऊ नये म्हणून तसेच कोणत्याही सायबर हल्ल्यामुळे  
त्यास नुकसान पोहचू नये म्हणून सदरची माहिती ०३ हार्ड डिस्क मध्ये जमा करून  
ठेवली आहे. सदरचे तिनही हार्ड डिस्क उपरोक्त नमुद कार्यालयातील फिर्यादींचे  
व्यक्तीगत वापरात असलेल्या केबीन मध्ये सुरक्षीत ठेवलेल्या असतात.



4

दि. २५/१२/२०२१ रोजी नाताळ निमीत्त फियार्दीचे घरामध्ये सामाईक तसेच फियार्दी यांचा मित्र स्वप्नील चव्हाण हे पार्टी करीता आलेले होते. त्या सामाईक मित्रांनी स्वप्नील यास डेटा एन्ट्री सेंटर का बंद झाले या बाबत विचार केली. त्यावेळी झालेल्या चर्चेत स्वप्नील चव्हाण यास राग आला आणि त्याने एन्ट्री सेंटर बंद होण्यामागे फियार्दी जबाबदार असल्याचे सांगून सर्वासमोर त्या व्यक्तीगत तसेच व्यवसायीक क्षेत्रात इजा पोहचवण्याची धमकी दिली. त्यानंतर ३१/१२/२०२१ रोजी नवीन वर्षानिमीत्त आयोजित केलेल्या पार्टीतही स्वप्नील चव्हाण यास सामाईक मैत्रीनीपैकी काहींनी डेटा एन्ट्री सेंटर बंद झाल्यामुळे विचारणा केल्याने तसेच नशा करण्याच्या सवईकडे ही त्याचे लक्ष वेधण्याचा प्रयत्न केला. स्वप्नील या त्याचा भयंकर राग आला आणि त्याने सर्वांशी भांडन केले. त्या भांडनातही त्या फियार्दींना तुझ्याकडे बघुन घेईन व तुला बर्बाद करेन अशी धमकी देवुन निघुन गेला.

दि. ०५/०१/२०२२ रोजी फियार्दीचे घरी काही मित्र मैत्रीनी जमलेले असताना स्वप्नील चव्हाण तेथे आला त्यावेळेस तो अमली पदार्थाच्या नशेत असलेले लक्षात आल्याने त्यांनी त्यास तेथुन निघुन जाण्यास सांगितले. त्यावेळेस त्याने फियार्दींना "तुझी सगळी माहिती माझेकडे आहे आता मी तुझे कसे नुकसान करतो ते तु बघच" असे हिंदी इंग्रजी मिश्र भाषेत सांगितले आणि तो तेथुन निघुन गेला. त्यावेळी रिंकु दुधानी ही मैत्रीण उपस्थित होती.

दि. ०६/०१/२०२२ रोजी फियार्दी त्यांचे ऑफीस मध्ये गेलो असता ऑफीसमध्ये त्यांचे ०३ हार्ड डिस्क पैकी ०१ हार्ड डिस्क मिळुन आली नाही. फियार्दीनी त्यांचे ऑफीस स्टाफ ला ऑफीस मध्ये हार्ड डिस्क शोधण्यास सांगितले. त्या गायब झालेल्या हार्ड डिस्क मध्ये भारतीय हवाई क्षेत्राशी संबंधीत महत्वाची माहिती, फोटो तसेच त्यांचे व त्यांच्या मैत्रीनिशी संबंधीत अतीशय व्यक्तीगत स्वरूपाचे फोटो तसेच व्हिडीओज आहेत.

दि. १६/०१/२०२२ रोजी फियार्दीची जवळची मैत्रीण रिंकु दुधानी रा.ठी. चेंबुर, मुंबई हिने त्यांना संपर्क करून स्वप्नील चव्हाण याने त्याचा मो. क्रमांक ८५९१०७७०९६ वरून तीचे मो. क्रमांक ९८१९४२०८९० वर केलेले संभाषनाची ध्वणीमुद्रीत प्रत तसेच झालेले चॅट पाठवले. त्यामध्ये स्वप्नील चव्हाण याने फियार्दींची जवळची मैत्रीण रिंकु दुधानी हिचे समावेत त्यांचे व तिचे एकत्र असलेले व्हिडीओग्राफ तो सोशल मिडीयावर प्रसारीत करणार आहे तसेच इतर सामाईक मित्र मैत्रीनींना दाखवुन त्यांची बदनामी करणार आहे अशी धमकी देत असल्याचे स्पष्ट समजुन येते. तेव्हा फियार्दींनी ताबडतोब त्यांचे ऑफीस मधील सीसीटीव्ही फुटेज तपासले असता त्यामध्ये दि. ०५/०१/२०२२ रोजी १७:१४ वा.चे पासुन १८.२२ वा. पर्यंत स्वप्नील चव्हाण हा त्यांचे केबिन मध्ये त्यांचे अनुपस्थितीत आला होता. याचा अर्थ तो १ तास ८ मिनीटे या वेळेत त्यांच्या अनुपस्थितीत ऑफीसमधील एक हार्ड डिस्क चोरी केल्याचे त्यांना दिसुन आले.

दि. १९/०१/२०२२ रोजी फियार्दीची मैत्रीण रानो दुबे हिचे मो. क्रमांक ७३०४८२०९४ वरून स्वप्नील चव्हाण याने त्यांचे मो. क्रमांक ८५९१०७७०९६ वरून तिला कॉल करुन ऑफीस मध्ये तिला आणुन तिचे मो. क्रमांक ८५९१०७७०९६ वरून असलेले अत्यंत वैयक्तिक व खाजगी फोटो दाखवले असे रानो दुबे हिने त्यांना सांगितले. त्यानंतर स्वप्नील चव्हाण याने रिंकु दुधाने व रानो दुबे यांना फियार्दींचे समावेत असलेले अत्यंत व्यक्तीगत व खाजगी व्हिडीओ तसेच फोटो प्रसारीत करुन त्यांच्या खाजगी आयुष्यात बाधा पोहचवण्याची धमकी दिलेली आहे.



मगील १० दिवसापासुन स्वप्नील चव्हाण हा वेगवेगळ्या लोकांमार्फत संदेश पाठवुन फिर्यादीचेकडे ५० लाखाची मागणी करत आहे. अन्यथा हार्ड डिस्क मधील गोपनीय माहिती तसेच त्यांचे व्यक्तीगत आयुष्याशी संबंधीत अत्यंत खासगी स्वरूपाचे फोटो व व्हिडीओ सर्वत्र प्रसारीत करण्याची धमकी देत आहे.

तरी स्वप्नील चव्हाण याने मैत्रीच्या विश्वासापोटी फिर्यादींनी त्यास वेळोवेळी त्यांचे व्यवसायीक तसेच व्यक्तीगत आयुष्याबाबत दिलेल्या माहितीचा दुरुपयोग केला, व त्यांचे ५ बी, ३२ आणि ३४, अक्षय मित्तल इंडस्ट्रीयल इस्टेट, एम व्ही रोड, अंधेरी पूर्व, मुंबई ५९ येथील कार्यालयात दि. ०५/०१/२०२२ रोजी त्यांचे अनुपस्थितीत त्यांचे केबीन मध्ये ठेवलेल्या हार्ड डिस्क ची चोरी करून त्यामध्ये असलेली गोपनीय व्यवसायीक माहिती तसेच व्यक्तीगत खासगी स्वरूपाचे फोटो व व्हिडीओ अनाधीकृत रित्या मिळवलेले आहेत. फिर्यादींचेबद्दल त्याचे मनात असलेल्या आसुया व द्वेषा पोटी तसेच त्याच्या व्यावसायीक अपयशात ते जबाबदार असल्याचा पुर्वग्रह बाळगुन त्यांचेवर सुड उगवण्याच्या उद्देशाने तसेच त्यांचेकडुन ५० लाख रूपयांची खंडणी उकळण्याचा हेतुने फिर्यादींना तसेच त्यांची मैत्रीन रानो दुबे आणि रिकु दुधानी यांना वारंवार धमक्या दिल्या म्हणुन फिर्यादी यांनी समक्ष पोलीस ठाणेस येवून दिलेल्या तक्रारीवरून त्यांचा सविस्तर जबाब नोंद करून वर गुर.क्र. ५५/२२ कलम ३८०, ३८४, २९२, ५०६(२) भादविसं. सहकलम ६६(बी) माहिती तंत्रज्ञान अधि अन्वये नोंद करण्यात आला. आरोपांतांस दि. २२/०२/२०२२ रोजी अटक करण्यात आली असुन आरोपी सध्या न्यायालयीन कोठडीमध्ये आहे.

तरी खालील कारणामुळे अटक आरोपीस जामीन मंजुर होण्यास पोलीसांची सक्त हरकत आहे.

१. नमुद गुन्ह्यात चोरीस गेलेली हार्ड डिस्क हस्तगत करणे बाकी आहे. सदर हार्ड डिस्क मध्ये महिलांचे खासगी व संवेदनशील फोटो आहेत.
२. आरोपीने फिर्यादीचे हार्ड डिस्क मधील माहितीचा दुरुपयोग केला आहे का? या बाबत तपास करित आहोत.
३. आरोपीचा आनखी कोणी साथीदार आहे का? आरोपीने सदरचे कृत्य कोणत्या कारणास्तव अथवा कोणाच सांगण्यावरून केले आहे का? तपास सुरू आहे.
४. आरोपीतास जामीन मंजुर झाल्यास तो फिर्यादी व साथीदार यांना धमकीवजाची दाट शक्यत आहे.

तरी उपरोक्त कारणामुळे अटक आरोपी स्वप्नील चव्हाण यास जामीन मंजुर होण्यास पोलीसांची सक्त हरकत आहे.

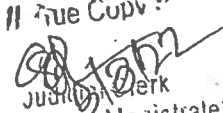
// True Copy :-  
  
 Metropolitan Magistrate's  
 33rd Court Andheri Mumbai

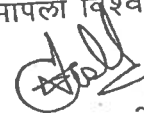

आपला विश्वासु,

  
 (विशाल पाटील)

पोलीस निरीक्षक  
 सहार पोलीस ठाणे, मुंबई.

seen

mml

28/02/22

IN THE COURT OF M.M. COURT 63<sup>rd</sup> COURT<sup>6</sup>

551/BA/2022

At. ANDHERT, MUMBAI

2.10.2022

25/02/2022 C.R. NO. 55/2022

Sahar Airport Police Stn. complainant  
v/s  
Swapnil Baban Chavan. Accused

Application for bail

u/s - 380/384/292/506(II) I.P.C 66(B) I.T. Act  
(arrested on - 23/2/2022) by Sahar P. Stn.  
MOST Respectfully submitted as under:-

① that the present FIR has been registered on false and bogus facts. The facts stated in the FIR are fabricated, concocted and without any basis.

② that the police has falsely implicated the applicant and arrested him in the present case, the applicant is a respectable citizen of the society and not involved any criminal case.

③ that the brief of fact is the complainant is a professional pilot who works for various aviation companies. He has owned office at Andheri the complainant company has been operating many country since the last 10 years. In connection with that works we have collected confidential information.

App. by I.O.  
to file. Day

25/2/22

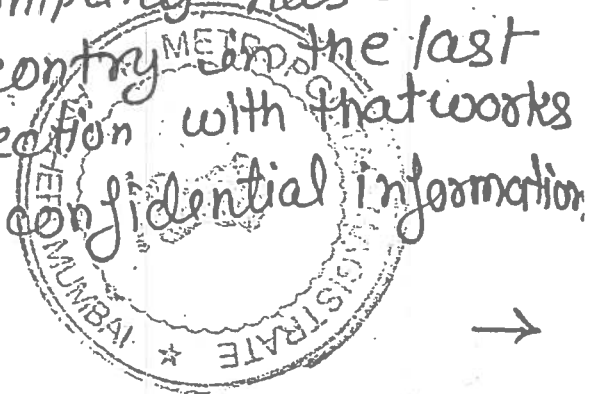
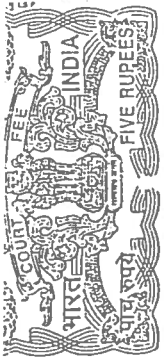

relating to airports in outside India, no one else in the company can see except the complainant. This confidential information is stored on 3 hard disks so that it is not stolen and it is not damaged by any cyber attack.

④ That complainant said the Accused a friend of the complainant, who is a complainant going for pilot training that accused also came for pilot training. That Accused became addicted to drugs due to bad company and as a result he could not complete the pilot training. Complainant said the Accused had developed jealousy and hatred for him. Complainant came to India in 2010. Complainant met the Accused many times on different occasions and discussed with Accused about many important issues related to his personal and business life.

⑤ That complainant started business with Accused (call center) and the Accused did not pay attention to the business so that call center business went bankrupt and had to close down. Complainant again started business with the Accused that the business is also close down.



(3)

⑥ On the occasion of Christmas, the complainant common friend and Accused had come to the house for a party. At the time common friends asked Accused why the data would be close during the discussion. Accused got angry and threatened to harm him in public as well as in the business sector. On 6/1/22 of his 3 hard disk did not come in the office. Complainant asked office staff to search the important information related to Indian airspace as well as very personal photos and videos related to her and her friend. That the Accused along with his close friend, is threatening to defame him by showing a video-graph of him and one of his friends as well as other common friends. The complainant immediately checked the CCTV footage in his office and the accused was in his cabin absence. This means that he was 1 hour and 8 minutes in complainant absence in the office on 19/11/2022, it was discovered that he had stolen the disc. That the accused showed Rani Chabey a very private photo together.



9

(7) complainant said For the last 10 days that the accused has been demanding Rs. 50 Lakhs from the comp. by sending message through different people. otherwise, it is threatening to spread confidential information on hard disk as well as highly private photos and videos related to their personal lives. Prayer →

(8) that the Accused is not required in any kind of investigation nor any kind of custodial interrogation is required nor any recovery is to be made at the instance of the Accused.

(9) that the Accused is a permanent resident and there are no chance of his absconding from the course of justice.

(10) that the applicant/accused undertake to present himself before the police/court as and when directed.

(11) that the accused further undertake not to tamper with the evidence or the witness in any manner.

(12) that the accused is ready and willing to accept any other conditions may be imposed by the court or

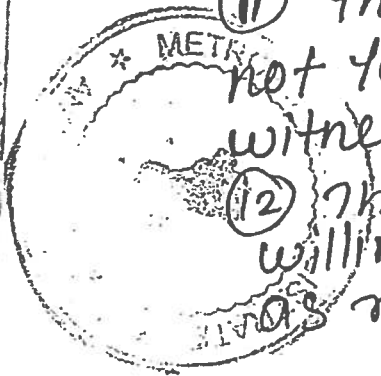

The police in connection with the case.

It is therefore prayed that the court may order for the release of the accused on bail in the interest of justice.

Any other order which the court may deem fit and proper in the facts and circumstances of the case may be also passed in favour of the accused applicants.

And for this Act of kindness accused's duty bound shall ever pray.

Mumbai

Date - 25/2/22

*[Signature]*

Adv. for Applicants/  
Accused  
FOR: Adv. S. S. GHANDHI

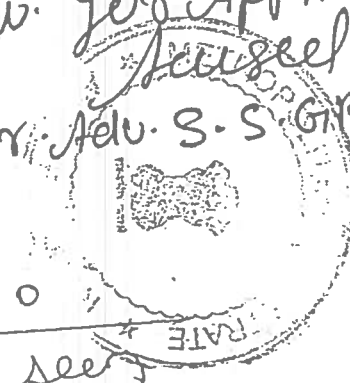

Amel

28/02/22

Say of APP  
As matters  
the alleged offence is non-bailable  
and serious in nature. There is  
possibility of tampering with the  
evidence and flow away from  
justice. Investigation is at initial  
stage. The hard copy is not recovered  
yet. Hence application is opposed  
and objected *[Signature]*  
28/02/22  
APP

"True Copy"

*[Signature]*  
JUDGE

Metropolitan Magistrate's  
33rd Court Andhera Mumbai

11:02



< 34



+44 7983 855602



Today

🔒 Messages and calls are end-to-end encrypted. No one outside of this chat, not even WhatsApp, can read or listen to them. Tap to learn more.

🕒 You use a default timer for disappearing messages in new chats. All new messages will disappear from this chat 7 days after they're sent. Tap to update your own default timer.

Hello, this message is to give you heads up about this fraud and criminal man

10:28 PM

Mr Amit Agarwal.. he is involved in many criminal activities.. he was also arrested in the month of April first r falsely representing himself as consulate

10:29 PM

We don't know amit amagrwal

10:30 PM ✓✓

I guess u sending wrong number

10:30 PM ✓✓

Nishant pitti .. ease my trip ?

10:30 PM

Yes 10:30 PM ✓✓

Oh k this guy was bragging in some party that you are his best friend

10:30 PM

Sorry to bother you may be he was lying

10:31 PM





Oh k this guy was bragging in some party  
that you are his best friend

10:30 PM

Sorry to bother you may be he was lying

10:31 PM

Forwarded

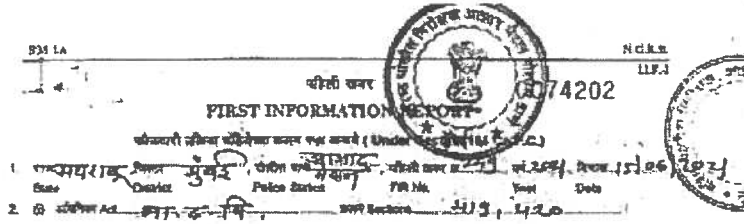

pdf Consulate FIR Copy.pdf

5 pages • 2.7 MB • pdf

10:34 PM

Forwarded

### Andheri bizman held for falsely representing the govt of Congo

Andheri businessman held for falsely representing the govt of Congo

pdf TOI Mumbai 09.04.2022.pdf

1 page • 763 KB • pdf

10:34 PM



7:51

4G



+44 7983 855602



3:46 PM

He has been spreading this news to everyone that Samir Bhai took 20 lakhs from him and he didn't do any work which he asked u to do

3:47 PM

I don't mean to offend you but he mentioned that you also asked him to book tickets for Budapest and he said " ye chutiye ki kanni kaatni padegi " .. my intention is just to give you heads-up about this man who is spreading negative news about you in the market 🙏

7:46 PM



3:54

4G



+44 7983 855602

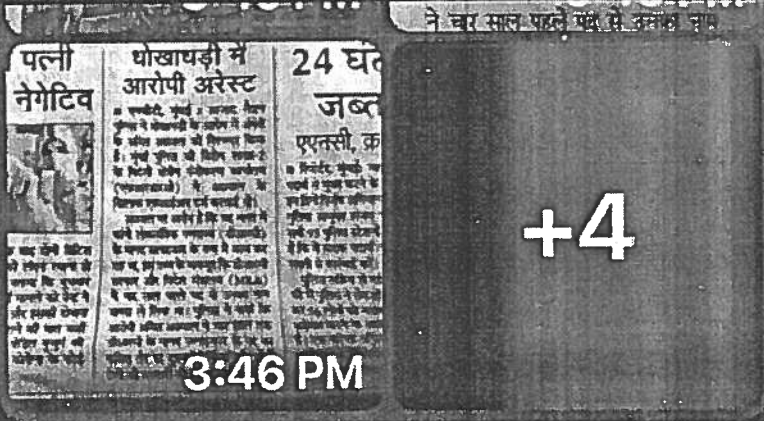

3:46 PM

Did you take any money from this criminal?

3:46 PM

He has been spreading this news to everyone that Samir Bhai took 20 lakhs from him and he didn't do any work which he asked u to do

3:47 PM

This sender is not in your contacts.

Block

Report

Add to Contacts



13:45

VoLTE LTE1 VoLTE LTE2 78%



Sameer Upadhyay...



but he mentioned that you also asked him to book tickets for Budapest and he said " ye chutiye ki kanni kaatni padegi " .. my intention is just to give you heads-up about this man who is spreading negative

11:17 ✓✓

See I am mature enough and I don't stand this type of dirty tricks by anyone.

I had send Dhruv because he can be in loop to know rest such type of people I don't take them seriously.

But this you have to introspect how can your people can make a nuisance for you. I don't need any clarification as I know that this can be done to harm our relationship.

12:18

Sameer Upadhyay Dhruv Agrawal  
See I am mature enough and I don't stand this type of dirty tricks by anyone....

Thanks

Yes this piece of shit has so far targeted 30 people

Like yourselves

With pure intention to spoil relationships and harm me

12:27 ✓✓



Message



← Dhruv Bhai



09:03

Forwarded

Someone from UK send me this message 09:03

Forwarded

For Amit Agrawal 09:03

No 09:03

Some fake guy I think 09:03



Forwarded

But he had send so many things 09:03

Forwarded many times

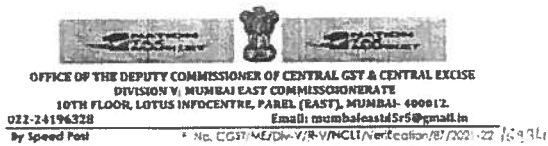

PDF Central Exise Claim.pdf

7 pages • 453 kB • PDF 09:03

Message



8:43

Voice LTE 4G+ 15%

← +44 7983 855602



Dnt u think to ask 10 lakh frm a house wife is fair enough

12:45 pm ✓✓

Don't u think fucking around after marriage and kids is fair?

12:46 pm

Let your community watch your video

12:47 pm

Fuck your money

12:47 pm

I knw dat...bt y u wana gt dis thing done wit me..

12:47 pm ✓✓

Plz u need to believe me..

12:47 pm ✓✓

I don't trust you now

12:47 pm

Deal was simple

12:47 pm

I'm gonna fuck your image now

12:47 pm

C if u cleae things simply wit me...i ll clear it in a nice way

12:48 pm ✓✓

Your kids will hate you all your life

12:48 pm

Let your husband kick your ass

😊 Message



8:43

Ver 4G+ 15%

←  +44 7983 855602



Now let your husband your  
children watch your drama 12:41 pm

Tl me 1 thing u r in london rite  
12:42 pm ✓✓

Hw ll i even pay u.. 12:42 pm ✓✓

I know all the ways 12:42 pm

And now I don't want money from  
you 12:42 pm

I'll claim from your husband  
12:42 pm

Listen dude... 12:42 pm ✓✓

Fuck yourself 12:42 pm

I didn't wanted to do this 12:42 pm

Hw does it matter if he knws  
12:43 pm ✓✓

U didnt tl mw nt to tl him 12:43 pm ✓✓

But your wrong actions will haunt  
you fornyour life 12:43 pm

He needs to pay for his mistakes  
12:43 pm ✓✓

 Message



8:43

VoLTE 4G+ 15%



+44 7983 855602



Yeah 12:43 pm

U tl mw hw to gt out of all dis...

12:43 pm ✓✓

I dnt want b involved into all dis..

12:43 pm ✓✓

+44 7983 855602

If you disclose this with anyone

12:43 pm

U meant by policw rite 12:44 pm ✓✓

No 12:44 pm

I meant anyone 12:44 pm

It doesn't matter even if u disclose it

12:44 pm

But you broke the rules 12:44 pm

And i don't think you are capable to pay

12:45 pm

I'll give the same deal to your husband

12:45 pm

Let see if he is interested to save your character

12:45 pm

Dnt u think to ask 10 lakh frm a



Message



8:44

VoLTE 4G+ 15%

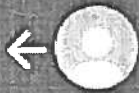

+44 7983 855602



Den y me...i dnt even knw u...

12:51 pm ✓✓

Am just doing my job 12:51 pm

I don't know you either 12:51 pm

I was doing my job 12:51 pm

You should have obeyed 12:51 pm

U shld hav being cleard na...

12:52 pm ✓✓

I just tld him...dnt msg  
me ever...bcoz of u...m in  
trouble...dats all

12:52 pm ✓✓

He shld realise his mistake as well

12:52 pm ✓✓

You told him about the videos you  
Fucking bitch

12:56 pm

No...i didnt 12:57 pm ✓✓

You did 12:58 pm

I don't think you care about your  
character

12:58 pm

I think you are okay with people  
watching your video

12:59 pm

😊 Message



7:40

Vodafone 4G+ LTE 7%

←  +44 7983 855602



Sorry in advance 7:23 pm

But I have to publish those videos  
7:23 pm

They have given me certain data  
which includes few relatives from  
your husband side and your kids  
school staff  
7:24 pm

You blocked this contact. Tap to unblock.

You unblocked this contact.

2 Unread Messages

Today

Shikha you don't want to respond?  
7:21 pm

Should I just proceed 7:21 pm

The sender is not in your contact list

 REPORT

 BLOCK

 ADD TO CONTACTS

 Message



8:43

VoLTE 4G+ 15%



+44 7983 855602



BLOCK

ADD

Today

🔒 Messages and calls are end-to-end encrypted. No one outside of this chat, not even WhatsApp, can read or listen to them. Tap to learn more.

You think you are smart 12:35 pm

Wat hav i done... 12:38 pm ✓✓

You told everything to mr agarwal  
12:38 pm

You think your WhatsApp is not getting recorded  
12:40 pm

He shld knw his mistake as well...  
12:41 pm ✓✓

You bitch 12:41 pm

Y m i suffeeing bcoz of his rivalry wit ne1  
12:41 pm ✓✓

Omg...ur language 12:41 pm ✓✓

Yes 12:41 pm

Now let your husband your children watch your drama  
12:41 pm

😊 Message





Shikha Agar...

Active now



I hav seen it personally

Wats wrong wit u damn

Listen i hav to msg him today again



What's there in the video

Drawing room sofa kissing n all

My oxygen is still nt stable witout cylinder



N i dnt knw wat to do...

Just relax

He ll sen dat video to my husband

He said he ll viral it



He askd me nt to tl ne1

Don't get into that nonsense

That's all bullshit

Seen just now



Message...





Shikha Agar...  
Active now



Now what

Sum1 frm london has my video

N is aksing 10 lakh rupees

Wat else u want

Msgd on watsapp frm +44

I dnt knw hw many girla r gonna die...

I dnt knw wat m i gonna do



M hospitalised

Ask for the video my love



Couldnt breathe properly

And send me those chats

He called me video call n shwd me...

I hav seen it personally

Wats wrong wit u damn



Listen I hav to msg him today again

What's there in the video



Drawing room sofa kissing n all



Message...



10:23

VoLTE 4G LTE 41%



Swapnil Chauhan  
online



I guess v had a chat before a mnth  
almost

10:20 pm ✓✓

Okk 10:20 pm

My sis in law was here for a  
mnth ...i was too occupied ..

10:20 pm ✓✓

Just may mnth...crazy guesting....

10:21 pm ✓✓

U met him a day before he left for  
states

10:21 pm

U were in mumbai for some  
function

10:21 pm

Just for your sake am telling u this

10:22 pm

He is on radar 10:22 pm

All his movements are watched by  
his enemy

10:22 pm

Stay away from him u are married  
with kids

10:22 pm

Staying in touch with him can get u  
in some trouble

10:22 pm

Serious trouble 10:22 pm

Message





# SUPREME TRANSPORT ORGANISATION PVT LTD



5B 34 Mittal Ind Estate MV Road Andheri East Mumbai 400059 INDIA +91 9870811224

8601 Park Lane #313

Dallas TEXAS

USA +1 703 810 9054

www.supremeaviation.com

ammeet@supremeaviation.com

www.stopl.in

kamal@stopl.in

\*\*\*\*\*

January 7<sup>th</sup> 2022

AB1 Shinde  
R2 +1/A

To,

**Shri Sanjay Ji Govilkar**

Senior Police Inspector, Sahar Police Station

Andheri East, Mumbai 400059

वरिष्ठ पोलीस निरीक्षक,  
सहार पोलीस ठाणे, मुंबई  
दिनांक 10/01/2022  
TR/3/10/23

**Re: To register FIR, requesting inquiry, investigation followed by appropriate action as per law, in a matter of fraud of Rs. 7+ Crores by:**

1. **MR. VIMAL AGRAWAL & NUPUR AGRAWAL** +91 93421 37351

Resident of B306, Sai Krupa Elite, Doddenkundi,  
Fern City Rd, Marathahalli, Bengaluru 560037

2. **MR. GIRISH AGRAWAL & SAMIXA AGRAWAL** +91 9311701121

Resident of A40 Kewal Kunj Apt, Sector 13, Rohini, New Delhi 110085

3. **Ms. PINKY AGRAWAL**

+91 98230 84559

Resident of BHAYANDER

4. **MR. SWAPNIL CHAVAN & MS. SNEHA**

+91 85910 77096

Resident of Chavan Chawl, Marol Maroshi Road, Andheri East, Mumbai 59

5. **MR. ATUL PANDEY & MS. RAJINI PANDEY**

+91 98672 42345

Resident of Yogendra Bhawan, JB Nagar, Andheri East, Mumbai 59

6. **Mr. Kamlesh Bairwa Tatawat**

+91 80786 55144

Resident of 89D, Narayan Vihar – 1<sup>st</sup>, Jagannathpura, Sanganer, Jaipur 302029

7. **Mr. Ramesh Kakria**

+91 98700 85405

Resident of Gokuldharm, Goregaon East, Mumbai 400097

\*\*\*\*\*

Respected Sir,

We seek your indulgent consideration, on the subject afore mentioned, on behalf of M/S Supreme Transport Organisation Pvt Ltd:

1. Please find attached ANNEX – 1, a letter from AUDITOR C.A. Girish Mundada, confirming fraud of more than Rs. 5 Crores conducted by accused number 1 to 3 afore mentioned.

2. Please find attached ANNEX – 2, a letter copied to us as party 4, which clearly indicates fraud of more than Rs. 1.70 Crores conducted by accused 4 to 6 afore mentioned.

\*\*\*\*\*



Continued..



SUPREME  
AIRLINES

*From Where.. Dreams take off...*

ISO 9001: 2008

CIN# U60230MH2008PTC216143

PAN# AAMCS0611A GST# AAMCS0611A2ZU

MSME #27222200461



# SUPREME TRANSPORT ORGANISATION PVT LTD



5B 34 Mittal Ind Estate MV Road Andheri East Mumbai 400059 INDIA +91 9870811224

8601 Park Lane #313

Dallas TEXAS

USA +1 703 810 9054

www.supremeaviation.com

ammeet@supremeaviation.com

www.stopl.in

kamal@stopl.in

\*\*\*\*\*

Continued..

3. Please find attached ANNEX – 3, a letter dated 24<sup>th</sup> June 2022, which clearly talks about cash and fraud of more than Rs. 10 Crores.
4. Property documents worth more than Rs. 2.5 Crores have been taken in illegitimate possession of accused #1 afore mentioned (annexure – 4 copies of such documents)
5. Property documents worth more than Rs. 3 Crores have been taken in illegitimate possession of accused #2 afore mentioned (annexure – 5 copies of such documents)

\*\*\*\*\*

6. I, Captain Ammeet K Agarwal, aged 34 years, resident of 901 Bikaner Bhawan, JB Nagar, Andheri East, Mumbai 400059, living with my father Shri Kamal Agarwal and mother Mrs. Sangita Agarwal since 2015; and in Mumbai since birth in 1988; I am President, Director and CEO of M/S Supreme Transport Org Pvt Ltd (STOPL) and M/S Sangeeta Aviation Services Pvt Ltd (SASPL), with head offices at 5B 34 and 5b 32, Akshay Mittal Industrial Estate, MV Road, Andheri East, Mumbai 400059 for more than 10 years; am a Commercial Pilot by qualification, holding licenses from USA.
7. In the month of September 2022, we came to know through Bank of India branch in Bengaluru, that from STOPL's account, accused #1 Mr. Vimal Agrawal had transferred funds to his personal account. (Copy attached as annex 6 for your reference).
8. We immediately informed our auditor to further conduct investigation on such transfers and submit detailed report. His report was recently received (copy attached as annex 7 for your reference). This report was shocking since Mr. Vimal Agrawal along with his wife Nupur Agrawal, his brother Girish Agrawal, his wife Samixa Agrawal and their sister Pinky Agrawal, in the last few months, have siphoned off more than Rs. 5 Crores from our company's accounts and funds.
9. Our meditators tried to speak to them for amicable settlement of these funds. However, they simply replied to the mediators that these amounts are their salaries for last 4 years! How can Nupur, Samixa, Pinky – all 3 ladies draw salaries from the company?

Continued..



SUPREME AIRLINES

*From Where.. Dreams take off...*

ISO 9001: 2008

CIN# U60230MH2008PTC216143

PAN# AAMCS0611A GST# AAMCS0611A2ZU

MSME #27222200461



# SUPREME TRANSPORT ORGANISATION PVT LTD



5B 34 Mittal Ind Estate MV Road Andheri East Mumbai 400059 INDIA +91 9870811224  
8601 Park Lane #313 Dallas TEXAS USA +1 703 810 9054  
www.supremeaviation.com ammeet@supremeaviation.com www.stopl.in kamal@stopl.in  
\*\*\*\*\*

Continued..

10. Further, our mediators and auditor asked them, if they have any proof of authorization to draw salaries or pay themselves fraudulently in the name of salaries? **This is violation of the company's act.** To which obviously, they have no reply. Matter of fact, annexure 8 are prayers from accused #1 and #2's own petition filed before NCLT, where they have clearly prayed for Director's remuneration since April 2019. Hence they stating that they have drawn these funds as their remuneration or salaries, are contradictory to their own submissions in NCLT on oath.

11. Further, our mediators and auditors clearly asked if they have done any business or work, generated any sales or revenues for the company, at least in last 4 years? To which, it is obvious that they have not worked at all, hence fraud of more than Rs. 5 Crores is evident and clearly visible.

12. To avoid any further pressure from us, our mediators and others, both Vimal and Girish have filed a frivolous application/petition in NCLT on 11<sup>th</sup> November 2022. Such petition is now being used by them to blackmail us, to not inquire in their Rs. 5+ Crore fraud.

13. Further, Mr. Vimal tried to sell company's property/plot located at **Municipal New No.51/1, Situated at 9th A Main Road, Banaswadi, Bangalore**, for Rs. 2.50 Crores. His intention was to take the payment in the same Bank of India account of the company, which is in his control, and further siphon off Rs. 2.50 Crores of company's money to his personal account. He is still holding possession of original documents of company's property, which needs to be in company's headquarters, despite of our several instructions to him to deposit the company's property papers.

14. Further, Mr. Girish tried to sell company's property/plot located at **D 338 Aara Machine Wali Gali, Man Pawana Road, Opp Shabad Dairy, Bharti Vihar, Bawana Road, Doulatpur, Delhi 110 042**, for Rs. 3 Crores. His intention was to take the payment in the same Bank of India account of the company, which is in his and his brother Vimal's control, and further siphon off Rs. 3 Crores of

Continued..



SUPREME  
AIRLINES

*From Where.. Dreams take off...*

ISO 9001: 2008

CIN# U60230MH2008PTC216143

PAN# AAMCS0611A GST# AAMCS0611A2ZU

MSME #27222200461



# SUPREME TRANSPORT ORGANISATION PVT LTD



5B 34 Mittal Ind Estate MV Road Andheri East Mumbai 400059 INDIA +91 9870811224

8601 Park Lane #313

Dallas TEXAS

USA +1 703 810 9054

www.supremeaviation.com

ammeet@supremeaviation.com

www.stopl.in

kamal@stopl.in

\*\*\*\*\*

Continued..

company's money to his personal account. He is still holding possession of original documents of company's property, which needs to be in company's headquarters, despite of our several instructions to him to deposit the company's property papers.

**15. Further, Mr. Girish Agrawal has collected Rs. 1.20 Lakhs cash EVERY MONTH of RENT from this property, from his local renter, illegitimately against company's interest. This has been happening for at least last 4+ years, which itself amounts to more than Rs. 60 Lakhs in rental fraud of company's property.**

16. We request your offices to please arrest the accused; recover original property papers from them; their residences should be attached so that the company can recover such Rs. 5+ crores siphoned off by them from the company's funds.

\*\*\*\*\*

17. Accused #4 and #5 - Swapnil Chavan and Atul Pandey are believed to own and operate a shell company – M/S Million Air Pvt Ltd. This company is a fraudulent company, since it is not in compliance with the Income Tax, G.S.T., Ministry of Corporate Affairs and R.O.C. requirements as visible on websites. (Annex 9 Attached)

18. Both Swapnil Chavan and Atul Pandey have made M/S Sangeeta Aviation Services Pvt Ltd (SASPL), transfer more than Rs. 1.70 Crores to their personal accounts, their mother's account viz Mrs. Sneha Chavan and Mrs. Rajini Pandey; also in an account in DUBAI owned by Mr. Swapnil Chavan. (Annex 10 Attached)

19. Such monies are purely transferred against extortion and blackmailing, for submitting fake bids in state government tenders by their company Million Air Pvt Ltd (Annex 11 attached).

20. Mr. Swapnil Chavan was arrested by SAHAR Police on 22<sup>nd</sup> February 2022, for similar extortion and black mailing FIR registered by me. It is evident that both the accused have no jobs, no business, no source of income and hence since last few years, apart from black mailing and extortion, they cannot accept any other means of livelihood and survival. Your further investigation on them would reveal their background, income and source of livelihood.



SUPREME  
AIRLINES

*From Where.. Dreams take off...*

ISO 9001: 2008

CIN# U60230MH2008PTC216143

PAN# AAMCS0611A GST# AAMCS0611A2ZU

MSME #27222200461



# SUPREME TRANSPORT ORGANISATION PVT LTD



5B 34 Mittal Ind Estate MV Road Andheri East Mumbai 400059 INDIA +91 9870811224  
8601 Park Lane #313 Dallas TEXAS USA +1 703 810 9054  
www.supremeaviation.com ammeet@supremeaviation.com www.stopl.in kamal@stopl.in  
\*\*\*\*\*

Continued..

21. On further investigating through reliable sources, it was found that this entire money of Rs. 1.70 Crores, transferred to afore mentioned 4 account holders in Mumbai and 1 in Dubai, **was CASH WITHDRAWN COMPLETELY 100% by the accused.**

22. This further attracts the income tax, GST, PMLA and various government violations including HAWALA done from Dubai. They have set a precedent that anyone can operate a SHELL COMPANY, submit fake bids and BLACKMAIL genuine bidders to collect extortion monies of more than Rs. 1.70 Crores.

23. Swapnil Chavan has been sending WHATSAPP messages to more than 50 high networth individuals, senior bureaucrats, politicians, Bollywood and close contacts of myself, in last 4 months, using this number +44 7983 855 602 (Annex 12 attached).

24. Prima facie these messages have 90% generic content consisting of 20-25 forwards including FIR, news articles and other defamatory material AGAINST myself.

25. The balance 10% content is specifically targeted to stir poison between the recipient and myself. People who can confirm receipt of such messages:

i.	<u>Mr. Kuldeen Ranka IAS</u>	<u>P.S. to Hon CM Rajasthan</u>	+91 94133 64002
ii.	Capt Ajay Chauhan	Dir of Civil Aviation, Govt of Gujarat	+91 99099 18888
iii.	Mr. Dominic Savio	Chhattisgarh Civil Aviation Dept	+91 94255 20679
iv.	Mr. Ajay Sandey	Chhattisgarh Civil Aviation Dept	+91 881 7676 066
v.	Mr. Trivikram Joshi	Ex-MLA BJP Karnataka	+91 94481 10099
vi.	Mr. Sameer Upadhyay	Political Advisor to Paresh Rawal	+91 99100 72605
vii.	Mr. Dhruv Agrawal	OSD to a cabinet minister	+91 99603 83838
viii.	Mr. Nishant Pittie	Owner of STOCK LISTED COMPANY	+91 98110 49345
ix.	Mr. Sanjay Shah	Close contact of BJP lobby	+91 93249 68581
x.	Mr. Chandraprakash Todi	High Networth Businessman	+91 97648 35813
xi.	Dr. Sudhir Desai	Renowned Doctor in AMERICA	+1 269 275 2792
xii.	Mr. Neeraj Morarka	High Networth Businessman	+91 99201 33373
xiii.	Shama Sikandar	Bollywood Actress	+91 99303 06770
xiv.	Bina Gaikwad	Blackmailed by showing videos	+91 99300 12399
xv.	Shikha Agarwal	BLACKMAILED for 10 Lakhs by videos	+91 84692 22333
xvi.	Chandni Kanoria	BLACKMAILED by showing VIDEOS	+91 98203 43304
xvii.	Rinku Dudani	BLACKMAILED by showing VIDEOS	+91 98194 20890
xviii.	Capt Akash Agarwal	Resident of AMERICA	+1 703 810 9054

Continued..



*From Where.. Dreams take off...*

ISO 9001: 2008

CIN# U60230MH2008PTC216143

PAN# AAMCS0611A GST# AAMCS0611A2ZU

MSME #27222200461



# SUPREME TRANSPORT ORGANISATION PVT LTD



5B 34 Mittal Ind Estate MV Road Andheri East Mumbai 400059 INDIA +91 9870811224

8601 Park Lane #313

Dallas TEXAS

USA +1 703 810 9054

www.supremeaviation.com

ammeet@supremeaviation.com

www.stopl.in

kamal@stopl.in

\*\*\*\*\*

Continued..

26. Swapnil Chavan has been doing such nuisance, so that I don't take any further action against him, including exposing this scam of Rs. 1.70 Crores as afore mentioned.

27. Further, we have 2 video clips where Swapnil Chavan is clearly visible consuming drugs. It is strongly believed that all this money was used for illicit drug trading by him for his survival and income.

28. However, such illegitimate acts of Swapnil Chavan were informed to Commissioner of Police, Mumbai, which was marked and discussed with Joint CP CRIME, further ordered to investigate by CIU of Crime Branch. Swapnil Chavan handed over a cheque of Rs. 1.70 Crores to M/S Sangeeta Aviation Service Pvt Ltd, to settle the entire matter so no further FIR and arrest is made.

29. That cheque is evidence of his amounts of Rs. 1.70 Crores afore mentioned. However, that cheque has bounced and separate proceedings u/s 138 in appropriate courts of law are in process.

30. We request your office to conduct fair investigation followed by arrest of the accused at the earliest. Further, please help recover Rs. 1.70 Crores transferred to them for blackmailing and extortion.

\*\*\*\*\*

31. All the monies which were transferred to accused #4 and #5, were transferred by accused #6- Kamlesh Bairwa. Kamlesh along with Mukesh Bairwa, joined my office in November 2016 (Annex 13 attached). After handling complete accounting and operations of my companies for more than 6 years, they both disappeared in the last week of August 2022.

32. Mediators and auditors have spoken to both on several occasions, including asking them to return to office to continue the works. They both have refused, since they both fear exposure of the entire scam, after the complaint filed as per ANNEX -2.

33. Further, they both have all the usernames, passwords, access to all accounts, data and finances of our companies, EXCLUSIVELY. They both are believed to be hands in gloves with accused #1 to #5, since complete transactions are conducted by them or with their help.

\*\*\*\*\*



CIN# U60230MH2008PTC216143



SUPREME AIRLINES

*From Where.. Dreams take off...*

PAN# AAMCS0611A GST# AAMCS0611A2ZU

ISO 9001: 2008

MSME #27222200461



# SUPREME TRANSPORT ORGANISATION PVT LTD



5B 34 Mittal Ind Estate MV Road Andheri East Mumbai 400059 INDIA +91 9870811224  
8601 Park Lane #313 Dallas TEXAS USA +1 703 810 9054  
www.supremeaviation.com ammeet@supremeaviation.com www.stopl.in kamal@stopl.in  
\*\*\*\*\*

34. I was in USA from 16<sup>th</sup> May 2022 to 10<sup>th</sup> November 2022. I have lived in USA off and on from 2006. During my travel for 6 months, Mr. Varun Kakria, my executive secretary for last 8+ years, have disappeared from my office in August last week.
35. All my business, my works, my lobbying, my legal matters and each and every activity of both the companies and my family, were looked by Mr. Varun Kakria exclusively.
36. He started in 2014 at Rs. 18,000 per month / Rs. 2 lakhs per year package. In last 2 years he was drawing more than Rs. 1.65 Lakhs per month / Rs. 20 Lakhs package per year.
37. I believe, that Mr. Varun Kakria was aware of afore mentioned funds transfers, scams, siphoning conducted by accused #1 to #6, hence to escape, he disappeared in last week of August 2022. Especially after the letter which was received in June marked as Anx-3, he realized that sooner or later the scam would be exposed.
38. Prima facia, funds of more than Rs. 5 Crores have been transferred from the bank accounts to accused to #1 to #3. Funds of more than Rs. 1.70 Crores have been transferred to accused #4 and #5. All funds transfers have exclusively been done by accused #6. Considerable cash withdrawals in excess of Rs. 10 Crores are visible as well, and hence letter annexure 3 becomes sensible. Company's original property documents of Rs. 2.50 Crores are in illegitimate possession of Mr. Vimal Agrawal; Company's original property documents of Rs. 3 Crores are in illegitimate possession of Mr. Girish Agrawal. Hence crime and fraud has already been committed by all the accused, with evidence, hereby submitted for your perusal.
39. We request your office to fairly investigate this fraud and take appropriate actions as per law including immediate arrest of all the accused. I shall be available for statements and all further queries the department may have in this case. Thank you. Sincerely,

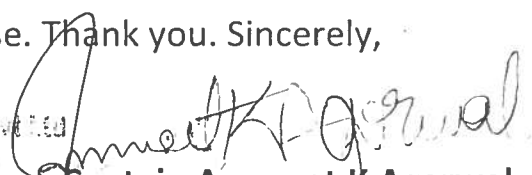

For Supreme Transport Organisation Pvt Ltd

  
Captain Ammeet K Agarwal  
President & CEO

Authorized Signatory  
\*\*\*\*\*



*From Where.. Dreams take off...*

ISO 9001: 2008

CIN# U60230MH2008PTC216143

PAN# AAMCS0611A GST# AAMCS0611A2ZU

MSME #27222200461

4:02

VoLTE 4G .lll 88%



+44 7983 8556...

Today at 3:23 PM



Today

🔒 Messages and calls are end-to-end encrypted. No one outside of this chat, not even WhatsApp, can read or listen to them. Tap to learn more.

Ab Teri baari !! 3:23 PM

The sender is not in your contact list

🗨️ REPORT

🚫 BLOCK

+👤 ADD TO CONTACTS

😊 Message





➔ Forwarded

Just passing on information  
of this criminal to everyone  
associated with him 11:59

➔ Forwarded

He was spotted in your parties  
11:59

➔ Forwarded

This man is a criminal and he is  
screwing many families 11:59

➔ Forwarded

I am just giving information to  
everyone 11:59

➔ Forwarded

This nice person is a rapist .. he  
tried to kill his own cousin 11:59

➔ Forwarded

He did many bank frauds 11:59

➔ Forwarded

And he was falsely representing  
himself as consulate for which  
he was arrested in the month of  
April 11:59

➔ Forwarded

Now his company is insolvent ..  
he has huge liabilities 11:59

➔ Forwarded

Whatever aviation work he did  
was fraud 11:59

➔ Forwarded

He use to sell this equipment  
to our state govt. By bribing  
the concerned officers ..  
this equipment was already  
decertified by usa in 2011 11:59

Forwarded  
This is in regards with the above tender 17:12

Forwarded  
I am RTI activist 17:12



WORK ORDER (S-I-C) OF 03 AATA... 3 pages - 663 KB - PDF 17:12

Forwarded  
This was a physical tender submitted by 3 companies 17:12

Forwarded  
This was all planned under the supervision of R.M. Dominic .. all three jokers who submitted the tender was associated with Mr Ammeet Agarwal.. 17:12

Forwarded  
I have written complaint from all three of them Mr Varun Kakarla representing Supreme transport pvt ltd .. Mr Swapnil Chavan representing Sangeeta Aviation pvt ltd .. Mr Atul Pandey representing Million air 17:12

Forwarded  
Fun fact .. Varun was Sangeeta aviation employee .. Swapnil and Atul are director of million air .. million air is a company formed only to bid against Sangeeta aviation in govt tenders .. there are no other activities in that company 17:12

Forwarded  
Ammeet Agarwal CEO of Sangeeta aviation is also a director in supreme transport in which his dad and cousins are majority share holder 17:12

Forwarded  
Tender was awarded to Sangeeta aviation services pvt Ltd.. after which the company went insolvent 17:12

Forwarded  
He registered a new company M/S Sangeeta Aviation Service Pvt Ltd with a new bank account tender awarded to Sangeeta aviation services Pvt Ltd even after several intimations from the creditors like Gannon Dunkerley And Co Ltd your department still credited the amount in his new bank account for obvious reasons 17:12

Forwarded  
How can your department credit the amount in the different bank accounts of the new company? It's a scam itself. 17:12

Forwarded  
We have all the evidence of this fraud and we will notify PMO and the Ministry of civil aviation. 17:12

Forwarded  
Also, he cheated Rajasthan as well as the Chattisgarh govt. .. Aatas were installed in 5 airstrips in Rajasthan. He uninstalled 3 AATAS from Rajasthan airstrips by giving them a false reason for repairing them. And installed the same 3 Aatas in Chattisgarh. 17:12

Forwarded  
It's not like your department is not aware of this. Those who are bribed are aware of this fact and you can double-check it with Principul Secretary Shri Kuldeep Ranka. 17:12

Forwarded  
Also AATAS is decertified by FAA in 2011 17:12



faa decertified.pdf 10 pages - 57 kB - PDF 17:12

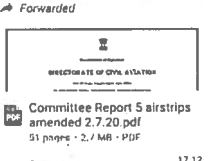

Forwarded  
Ammeet Agarwal is planning to abscond from the country, your department will be held responsible for this scam. 17:12

Forwarded  
We have video evidence of Mr. Agarwal where he made a statement that he bribed Dominic and through him, he successfully did this scam 17:12

Forwarded  
I am forwarding all the details to the Tender Committee, PMO, and the Ministry of civil aviation. I request all the officers who are not involved in this scam to highlight this scam, upfront to the relevant authorities. 17:12

Name - **Swapnil Baban Chavan**  
 DOB - 14-11-1988  
 PAN - AJDPC8248C  
 Address - Chavan House, Marol Maroshi Road, Opp-ICICI Bank,  
 Marol Mumbai, Mumbai Suburban, Maharashtra – 400059  
 Contact Number - +91 8591077096  
 Bank Account details - A/c No. – 104401531869  
 IFSC - ICIC0001044  
 Bank – ICICI Bank, Marol Branch, Mumbai

Bank Account details - A/c No. – 921010008877100  
 IFSC - UTIB0000328  
 Bank – Axis Bank, Andheri Kurla Road, Andheri (East)

Name - **Sneha Baban Chavan**  
 DOB - 06-01-1970  
 PAN - AJCPC3117B  
 Address - Chavan House, Marol Maroshi Road, Opp-ICICI Bank,  
 Marol Mumbai, Mumbai Suburban, Maharashtra – 400059  
 Contact Number - +91 8591077096  
 Bank Account details - A/c No. – 013200128873557  
 IFSC - SRCB0000013  
 Bank – Saraswat Bank, Marol Branch, Mumbai

**Mr Swapnil Baban Chavan**

Date	Particulars	Amount Paid
15-11-2019	EFT TO UTR#CITIN19062861722-SWAPNIL BABAN CHAVAN -OT - XXXXXXXX1869 -ICICI BANK LIMITED -MUMBAI -MUMBAI - MAROL -REF NO#090011829920107	2,00,000
18-03-2021	RTGS/DCBL202103185000003025/UTIB/Swapnil Baban C	5,00,000
18-03-2021	RTGS/DCBL202103185000009585/UTIB/SWAPNIL BABAN C	10,00,000
18-03-2021	NEFT/000001077014/UTIB/Swapnil Baban C	18,64,000
07-09-2021	MC ISSUED - ANDHERI MUMB - 008612164607 - - SWAPNIL BABAN CHAVAN	8,91,000
24-12-2021	IMPS:PAY:135817529323/104401531869/ICICI BANK	50,000.00
25-12-2021	NEFT/000006063130/ICIC/Swapnil Baban C	47,400.00
<b>TOTAL</b>		<b>45,52,400</b>

**Mrs Sneha Baban Chavan**

Date	Particulars	Amount Paid
04-07-2019	RTGS/DCBL201907045000004221/SRCB/CHAVAN SNEHA BA	3,00,000.00
31-08-2019	CMS:NEFT:SNEHA BABAN CHAVAN:013200128873557	2,00,000.00
15-11-2019	RTGS/DCBL201911155000001910/SRCB/SNEHA BABAN CHA	2,50,000.00
12-03-2021	NEFT/000000949766/SRCB/SNEHA BABAN CHA	5,00,000.00
13-03-2021	NEFT/000000976435/SRCB/SNEHA BABAN CHA	8,32,000.00
16-03-2021	RTGS/DCBL202103165000002156/SRCB/SNEHA BABAN CHA	17,82,000.00
HDFC 07-09-2021	RTGS DR-SRCB0000013-SNEHA BABAN CHAVAN-ANDHERI MUMB- HDFCR52021090763499932	8,91,000
<b>TOTAL</b>		<b>47,55,000</b>

**93,07,400**